

Safety Signs



Delivering safety, welfare, site equipment and tools
for the construction industry

w: onsite-support.co.uk | e: hello@onsite-support.co.uk | t: 01293 744 444

Introduction

Welcome to our 2022 - 24 Catalogue

This catalogue includes hundreds of new products, innovations, updates, redesigns and range extensions, making it our most comprehensive catalogue to date. We are confident that you will find the sign that you are looking for, but if you can't, we are more than happy to offer a bespoke solution to meet your requirements.

As ever we have kept an eye on changes to legislation and have developed innovative and practical products to ensure we continue to offer a comprehensive range of Health and Safety Signs and safety related products.

You can find more information about our most popular materials, along with details on how to order our signs, on pages 2 - 5.

Wherever possible all signs shown within this catalogue have been designed to display an approved ISO 7010 symbol. On the rare occasion where a symbol has yet to be adopted by International Standardisation, but has proven comprehension levels under BS 5499, these signs will be manufactured to BS 5499 Standards. Our signs also meet the required colorimetric and photometric properties as specified in BS ISO 3864 to provide a consistency in colour and design at all times and ensuring our customers receive a "technically correct" safety sign that meets all relevant UK legislation.

New and Featured Products

We offer a wide range of unique and innovative products throughout this catalogue. Below is a small sample of our latest and featured products. If you believe there's a popular range of products we don't currently provide please contact us and remember, if you don't find the item you require please let us know and we'll do our best to find a solution.

Eco-Friendly Signs 90 - 91



We are pleased to be able to offer customers an eco-friendly option when choosing their safety signage.

To help our customers identify signage that can be recycled, we have included a recycling logo on pages where signs can be recycled and have dedicated a section to some of our more popular signs in eco-friendly materials.

PPE Stations 72



Store and display essential PPE and help ensure all personnel and visitors have instant access to mandatory personal protective equipment.

Each station includes strong black polypropylene hooks from which to hang the relevant personal protective equipment, helping keep it safely stored in a prominent position. Customised versions are available upon request.

Electric Vehicle Signs 105



Prevent unauthorised vehicles from parking in spaces specifically reserved for the charging of electric vehicles and raise awareness of the correct use and locations of electric car charging points

Easily identifiable using the official DoT (Department of Transport) symbol but in safety green to highlight the environmental benefits of electric cars

Coronavirus Signs 138 - 141



Research revealed that 80% of people in the UK feel safer and are more likely to shop in stores / visit premises with clear, professional COVID-19 signage.

The findings also indicate that stores and brands risk reputational damage from inadequate COVID-19 signage, with 40% of people saying inadequate signage makes them feel the business isn't taking their safety seriously.

Farm Safety Signs 79



Highlight areas where it is vital that dogs are kept on the lead. Ensure that both livestock and pets remain safe by warning members of the public of potential risks.

Additionally using safety signs is necessary to meet legal requirements and protect the landowner from liability if someone is injured on their property.

Report Book Holders 45



Overcome the frequent issue of books being misplaced by ensuring that important log books are clearly visible and easily accessible with our wall mounted book holder stations.

Stations are pre-drilled for easy mounting and include a printed "missing" message to show when the log book has been removed.

First Aid Station 43



This first aid station ensures that life saving information and equipment is clearly visible at all times and is easy to access in case of an emergency.

The First Aid Station can save time in the event of an emergency by overcoming the frequent issue of first aid boxes being lost or misplaced.

Good to Go Safety 131 - 135



Regular equipment inspections can help identify potential faults before they develop into costly defects and /or hazardous to user welfare.

Using the Good to Go Safety system will help you improve safety, reduce maintenance costs and enable you to comply with the relevant legislation.

Other New and Featured Products

Fire Extinguisher Range Extension	6	Tool Tether Signs	37	Magnetic Document Frames	60	Adapt-a-Signs	88	Stencil Update	107
Tamper Proof Tags	7	First Aid Directional Arrows	41	Near Miss Products	64	Additional Braille Signs	89	Re-Flex Update	110
Fire Equipment Directional Arrows	8	First Aid PPE Station	43	New Floor Graphics	66	Engraved Signs	95	Worker ID Tags	123
Stairway, Level & Dwelling Signs	17	Safety Quote Posters	51	Cleaning Stations	72	Lock Out Tag Out	96	Barrier Tape Post	130
Industrial Vehicles / Robotics	28	Spill Kit Range	57	Littering and Disposal	77	Verge Sign Extension	104	Photoluminescent	131

Ordering

How to Order

Each product within this catalogue has its own unique product code. To help you understand the meaning of our codes, please follow the guidance below:

Step One

Find the sign you require by using the index page, contents page or by simply browsing the catalogue.



Step Two

When you find the sign required, use the **material grid** (on every double page spread) to find which materials are available for your chosen sign. Materials available are highlighted as **BOLD NUMBERS** at the start of every code.



Step Three

The **LETTERS** at the end of the code identify the available size options. To help choose the best size for your situation you should also take into account our recommended viewing distances (below) for safety signs.



Step Four

Once you've identified the sign, material and size required, use fold-out price list (or request a copy) to find the price.



Products which begin with **5** are listed on a page-by-page basis.

Code Example

The forklift sign to the right is available in four standard material options '1, 2, 7 & 8' you can refer to pages 4 - 5 for more detailed material information.

The unique design code is '3407'

Each letter identifies an available size option for the sign. **SQUARE** letters represent landscape orientations. **CIRCLES** represent portrait orientations.

5 codes refer to products with miscellaneous materials / sizes and therefore have the details required beside the code. (e.g. Floor Graphic 400 x 600mm)

If the sign you require doesn't come in the material / size you're after, don't worry we can manufacture any design to your exact specifications.



Forklift trucks prohibited beyond this point

1	3407	G	M	K	P	Floor Graphic	400 x 600mm
2	3407	G	K				5 8737
7	3407	P					
8	3407	K					

Size Codes | **5 Series**

Design Code

Material Codes

Viewing Distances

There are many factors that can influence a person's ability to view a sign, all of which are covered in depth by BS ISO 3864-1, these factors should be considered when deciding on your choice of sign size. The maximum distance a person will be required to view the sign, the angle they are viewing the sign from, lighting, and vision impairment can all have significant influences on the ability to read and comprehend a safety sign.

It is also worth considering the room layout to ensure signs are not obscured by furnishings. Situating signs at a suitable height maximises their potential to be seen.

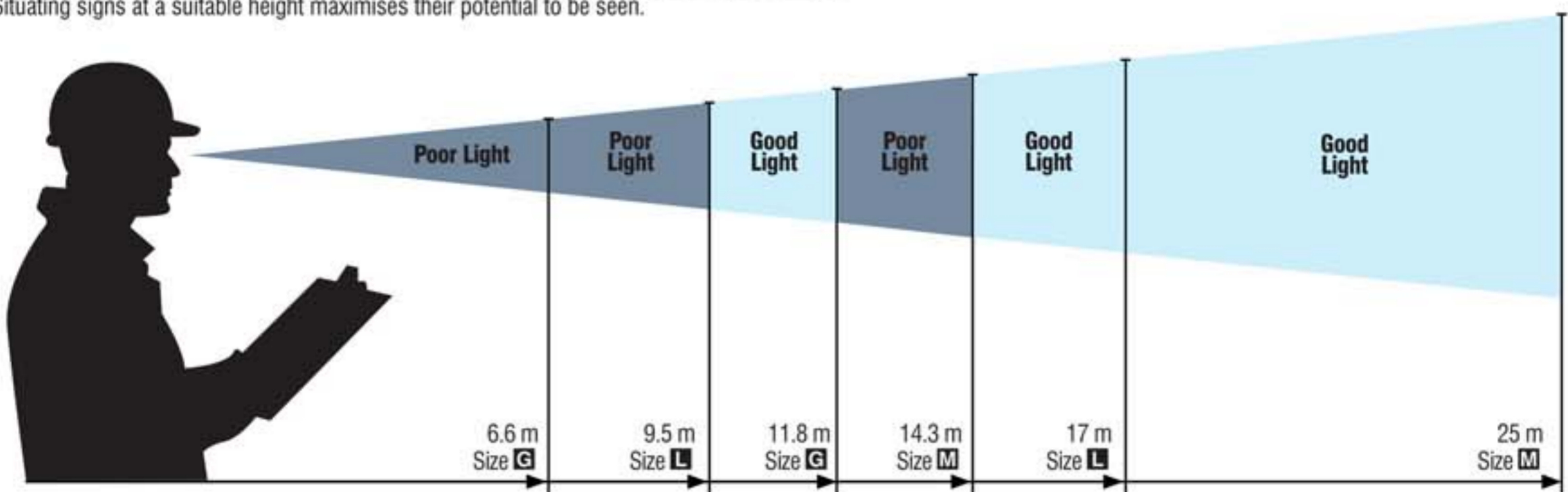

These distances are for guidance purposes only. Please refer to BS ISO 3864-1:2011 for specific calculations.

The example above shows an estimate viewing distance for three of our most popular sign sizes depending on conditions of light.

Material Codes

- 1 Rigid Plastic
- 2 Self Adhesive Vinyl
- 3 Photoluminescent Rigid Plastic
- 4 Photoluminescent Self Adhesive
- 5 Miscellaneous
- 6 Aluminium
- 7 PET
- 8 Quick Fix

Landscape Sizes

- A** 100 x 75mm
- B** 80 x 80mm
- C** 150 x 150mm
- D** 150 x 100mm
- E** 200 x 150mm
- F** 200 x 200mm
- G** 300 x 100mm
- H** 300 x 250mm
- J** 400 x 200mm
- K** 400 x 300mm
- L** 450 x 150mm
- M** 600 x 200mm
- N** 400 x 400mm
- P** 600 x 400mm
- Q** 600 x 450mm
- S** 200 x 75mm

- U** 100 x 100mm
- V** 300 x 150mm
- W** 900 x 600mm
- X** 200 x 100mm

Portrait Sizes

- A** 75 x 100mm
- B** 80 x 80mm
- C** 150 x 150mm
- D** 100 x 150mm
- E** 150 x 200mm
- F** 200 x 200mm
- G** 100 x 300mm
- H** 250 x 300mm
- J** 200 x 400mm
- K** 300 x 400mm
- L** 150 x 450mm
- M** 200 x 600mm
- N** 400 x 400mm
- P** 400 x 600mm
- Q** 450 x 600mm
- S** 75 x 200mm
- U** 100 x 100mm
- V** 150 x 300mm
- W** 600 x 900mm
- X** 100 x 200mm

Printing Processes

We have several printing processes which we use regularly. The choice is dependent upon volume, sign environment or content. Below are some of our more popular options:

Screen Print

This method is used for printing the majority of the safety signs within our catalogue. It ensures a high quality print, consistency of colour and a flawless finish.



Digital Print

This method of printing is ideal for short production runs, custom designs or signs that require full colour images to be included. We are able to digitally print directly onto a wide range of materials.



Engraving

Precision routing from computer generated designs provide a tactile, prestigious finish to a sign. The use of layered substrate materials allows the top surface to be cut away to uncover the coloured lower layer.



Vinyl Graphics

Computer cut vinyl graphics can be applied to a substrate (such as Rigid Plastic, Aluminium etc) or pre-cut, ready to apply vinyl lettering or graphics can be applied directly to almost any flat, dry and clean surface.



Custom Signs

If you cannot find the message, size or material that you require then give us a call and, wherever possible, we will be happy to quote for anything outside our standard range.

Whether it's for a prestigious hotel or an after school club, our custom made signs allow you to get creative and provide a truly unique signage solution. Once you know how you want your sign to look, simply follow the steps below to begin the process of creating a bespoke sign.

1. Sketch & Snap / Scan



Mock up your desired sign, take a picture of it on your phone and send it to us via email. Please don't worry if you're not artistically inclined just remember to include material, colour, text and sizes.

2. Snap & Email



If you've seen a sign you require simply take a photo of it on your phone and send us the picture. We'll then mock up the design based on your instructions and send you a proof to approve, following receipt of your order.

3. Send a Link



Seen a sign you like on a website? Send us the link or a screenshot, along with any additional comments relating to the size, material, or any alterations and we'll provide you with a quote. Please be aware, there may be copyright restrictions.

When ordering a sign, consideration should be given to the environment it will be located within – is it internal or external? Is it for display in a warehouse or a prestige hotel? Select the required material from the grid below. This grid is not exhaustive so if you can't see the material or size you require please contact us and we will be happy to quote.

Materials	Codes	Details Required for a Custom Sign Quote	Price	Popular Size Choices	
Rigid Plastic	CUST001	<p>Size: Please refer to our "Popular Size" chart or specify your own</p> <p>Orientation: Landscape or Portrait</p> <p>Quantity: Please state your required quantity</p> <p>Content: Please specify or provide artwork</p>	Supplied on Request	80 x 80mm	400 x 200mm
Self Adhesive Vinyl	CUST002			100 x 75mm	400 x 300mm
Photoluminescent Rigid Plastic	CUST003			100 x 100mm	400 x 400mm
Photoluminescent Self Adhesive Vinyl	CUST004			100 x 150mm	450 x 150mm
0.9mm Aluminium	CUST005			150 x 150mm	600 x 200mm
2mm PET (Polyethylene Terephthalate)	CUST006			200 x 75mm	600 x 400mm
Rigid PVC with SAV Backing (Quick Fix)	CUST007			200 x 100mm	600 x 450mm
3mm Foam PVC	CUST008			200 x 150mm	800 x 600mm
5mm Foam PVC	CUST009			200 x 200mm	900 x 600mm
3mm Aluminium Composite	CUST010			210 x 297mm	1050 x 750mm
0.9mm Reflective Aluminium	CUST011			300 x 100mm	1200 x 800mm
PVC Banner with Eyelets	CUST012			300 x 150mm	1200 x 1200mm
4mm Fluted Polypropylene	CUST013	300 x 250mm	2400 x 1200mm		

Image & Logos

Please ensure all images / logos you send are high resolution to achieve a quality print finish. A high resolution file JPEG, PDF, EPS or Ai file of your company logo is ideal. **Taking a logo from a home page of a website will not do.** Low-resolution images are the main reason for slow production of custom specials. Have your logo ready prior to order to ensure quick order turnaround.

If you are finding it difficult to find a high-resolution version of your logo you can sometimes find it via [images.google.com](https://www.google.com) simply drag your low-resolution logo file into the search bar and Google will search the internet for images that are similar. If there are any higher resolution logos found on the internet they will load. If all else fails we can reproduce your logo so it prints correctly - additional charges will apply.



Material Information

The first number you see on our product codes identifies the material the sign is made from, an overview of which can be found in this section. Deciding on your sign message is only the first step. When ordering a sign thought should also be given to where that sign is going to be displayed. Consider the environment it will be located within – is it indoor or outdoor? Is it for display in a warehouse or a prestige hotel? Our guide below will help you to decide which material is best for your location and covers our most popular sign materials – this list is not exhaustive so if you can't see the material you require please contact our sales team and we will be happy to quote in a material of your choice.

1. Rigid Plastic

Easily drilled, white, glossy, rigid plastic. A lightweight material with high impact strength, suitable for indoor and outdoor use. Rigid Plastic is the main material used for Quick Fix signs.



2. Self Adhesive Vinyl

High gloss, flexible PVC with self adhesive backing. Suitable for most smooth, dry and clean surfaces. Ideally suited for indoor use such as warehouse labelling.



6. Aluminium

Aluminium with gloss white powder coating. Ideal for both indoor and outdoor applications. Excellent weathering and UV resistance. A long-life product.



7. PET

2mm Thermoplastic Polyester (known as PET) is high quality, recyclable, durable, impact, fire and vandal resistant which makes it ideal for harsher environments.



8. Quick Fix

A white rigid plastic surface provides a durable finish, whilst a strong self adhesive backing removes the need for drilling, screws or additional fixings.

5. Miscellaneous Material Information

Any product outside of our standard choice of material or size ranges begins with a 5. This may include items such as rolls of tape, sign frames, banners, or any sign requiring bespoke designs. It may include products using (but not limited to) the following materials:

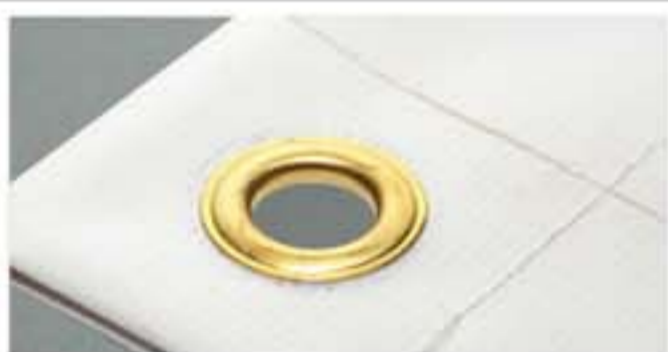

PVC Banner

Flame resistant, 440gsm PVC banner for indoor and outdoor applications. Digitally printed for eye catching displays.



Fluted Polypropylene (4mm)

Lightweight, waterproof, strong and 100% recyclable (Class PP5) making it ideal for temporary signage such as site safety signs.



Synthetic Paper

110gsm high density polyethylene. A highly durable, recyclable, tear, water and grease resistant material which is ideal for eye catching posters.



Foam PVC

Available in 3mm, 5mm or 10mm. Bright white, lightweight & waterproof. Easily drilled for fixing. Ideal for outdoor site safety boards.



Acrylic (5mm)

High quality, non-shatter, cast acrylic with a good resistance to weather, discolouring and most chemicals. 100% recyclable.



Aluminium Composite

3mm white aluminium skin with a polyethylene core. A lightweight and weather resistant material which is ideal for outdoor signage due to its non-existent scrap value.



Reflective

Available on various materials (aluminium, zinc & aluminium composite) with a choice of reflective finishes. RA1 reflective (engineering grade) for temporary traffic signs. R2 reflective (high intensity) for permanent traffic signs (CE marked).



Braille & Tactile

2-ply ABS thermoplastic material for both indoor and outdoor use. It offers a durable, scratch resistant, glossy surface. Available in various colours and surface finishes. Laser and routing capabilities offer a high quality finish.

Ultra Bright

3. Photoluminescent Rigid Plastic 4. Photoluminescent Self Adhesive Vinyl

Photoluminescent signs, tapes and markers work by storing energy from either a natural or artificial light source. If the light source is no longer available in the case of a blackout due to a fire or other emergency, then the "charge" in the sign releases light in the form of photons to produce a greenish luminant glow, also known as phosphorescence. The strength and quality of this glow can vary greatly between manufacturers and for this reason we have introduced the Ultra Bright brand to give assurance that all our photoluminescent signage exceeds PSPA (The Photoluminescent Safety Products Association) Class C ratings, making it one of the best in the UK market and ensuring our signs stay brighter for longer to give the maximum chance for a successful evacuation.

Photoluminescent signage is charged by light which allows it to glow in the dark if there is a sudden loss of light due to a power outage or if thick smoke from a fire is obstructing vision. Using this type of signage in a building can assist employees or members of the public to a safe refuge area away from the danger.

Ensuring that signage is clearly visible in blackout conditions can prove the difference between life and death during an emergency evacuation, helping guide people to exits and to essential equipment. The real beauty of photoluminescent products, in the context of a Safety Way Guidance System, is that they do not need electricity to glow in the dark if properly sited and maintained. In an emergency situation where a mains failure has occurred, they will immediately light the way to safety even in smoky conditions.

All Safety Way Guidance Systems (SWGS) must conform to the standards set out in BS ISO 16069. This stipulates requirements that need to be met with regard to the design, installation and performance for both photoluminescent and electrical SWGS. The benefit of these systems is that they are coherent and understood by all, regardless of culture or language. Occupants within your premises can be guided safely out of the building to a designated assembly/refuge point, in the event of an emergency. This is ensured as symbols on the signs must be compliant with BS EN 7010 and sign design must meet the requirements of BS ISO 3864 parts 1-4, to conform to BS ISO 16069.



To achieve high performance in low light conditions and conform to ISO 16069 we recommend using Ultra Bright. Ultra Bright range exceeds Class C and the table below indicates how Ultra Bright stays brighter for longer in comparison to PSPA classifications, with our signage remaining visible even after an hour in darkness.

Specifications & Benefits:

1. Exceeds Class C photoluminescent PSPA rating
2. Afterglow testing in accordance with DIN 67510-Pt1
3. Compliant with ISO 16069:2017 Safety way guidance systems (SWGS)
4. Maximises visibility of signs during smoky / black-out conditions. Provides clear guidance to exits and emergency equipment which helps significantly reduce evacuation times
5. Self re-chargeable and maintenance free - No power source / batteries required
6. Instant and long lasting visibility of signage in blackout conditions. It takes over 48 hours to totally fade from fully charged
7. Cost effective and easy to install
8. Non-toxic or radioactive pigments (REACH / RoHS compliant)

Luminance mcd/m2	2min	10min	30min	60min
Class A	108	25	7	3
Class B	210	50	15	7
Class C	690	140	45	20
Ultra Bright	957	199	59	26

The classification system is calculated on luminance decay after a given time which complies to ISO 17398:2004, ISO 16069:2017 and DIN 67510-Pt1

Ultra Bright Rigid Plastic

1.2mm rigid plastic with photoluminescent pigmentation.

Ultra Bright Self Adhesive Vinyl

0.35mm flexible self adhesive vinyl with photoluminescent pigmentation.

Recyclable Materials



We firmly believe in, and are committed to monitoring and improving environmental performance, pollution prevention and environmental protection during the manufacture of our safety signage. We implement a systematic waste minimisation programme to achieve objectives and targets to reduce waste, avoiding the use of terminal waste treatment and dealing with it as far as possible at source.

We pursue continuous improvement in environmental performance, where reasonably practicable, by setting objectives and targets, especially in addressing the areas of resource use, by reducing energy and water consumption, increasing reuse and recycling and improving solid and liquid waste management methods.

To help our customers identify which of our signage materials can be recycled, we have included the recycling logo on pages where signs can be recycled and have dedicated a section to some of our more popular signs in eco-friendly materials.

In addition, to help encourage an environmentally friendly approach to signage we now include the appropriate recycling logo on the sign to help identify when a sign can be recycled and to help recycling centres correctly identify and process the materials efficiently without the need to send them into landfill.

Although we only offer this feature on our two main recyclable materials, our acrylic and aluminium signs are also suitable for recycling.



With so many eco-friendly materials available, we're extremely happy and proud to provide more opportunities than ever for customers to take an eco-friendly choice when buying their safety signage.

PET



Thermoplastic Polyester, known as PET is appropriately marked with the number one and acronym PET. This plastic is easily recyclable so it's often part of curb-side recycling programs. It can be reused to make containers, carpet, and furniture.

PET signs are ultra durable, impact, fire and vandal resistant making them ideal for harsher environments. High quality finish.

Fluted Polypropylene



(Fluted) Polypropylene Plastic, known as PP, is appropriately marked by the number five and the acronym PP. This is one of the safer types of plastic making it ideal for ketchup and medicine bottles. It is also increasingly being accepted in curb-side recycling programs.

Fluted polypropylene signs are strong, lightweight and waterproof making them perfect for temporary installations.

We have access to many more alternative "green" materials so if you have a specific requirement please let us know and we will endeavour to provide the perfect solution to meet your specification.

Material Codes

- 1 Rigid Plastic
- 2 Self Adhesive Vinyl
- 3 UltraBright Rigid Plastic
- 4 UltraBright Self Adhesive
- 5 Miscellaneous
- 6 Aluminium
- 7 PET
- 8 Quick Fix

Landscape Sizes





- A** 100 x 75mm
- B** 80 x 80mm
- C** 150 x 150mm
- D** 150 x 100mm
- E** 200 x 150mm
- F** 200 x 200mm
- G** 300 x 100mm
- H** 300 x 250mm
- J** 400 x 200mm
- K** 400 x 300mm
- L** 450 x 150mm
- M** 600 x 200mm
- N** 400 x 400mm
- P** 600 x 400mm
- Q** 600 x 450mm
- S** 200 x 75mm
- U** 100 x 100mm
- V** 300 x 150mm
- W** 900 x 600mm
- X** 200 x 100mm



Portrait Sizes





- A** 75 x 100mm
- B** 80 x 80mm
- C** 150 x 150mm
- D** 100 x 150mm
- E** 150 x 200mm
- F** 200 x 200mm
- G** 100 x 300mm
- H** 250 x 300mm
- J** 200 x 400mm
- K** 300 x 400mm
- L** 150 x 450mm
- M** 200 x 600mm
- N** 400 x 400mm
- P** 400 x 600mm
- Q** 450 x 600mm
- S** 75 x 200mm
- U** 100 x 100mm
- V** 150 x 300mm
- W** 600 x 900mm
- X** 100 x 200mm





Fire Extinguisher Identification

The Regulatory Reform (Fire Safety) Order 2005 places responsibility of fire safety on employers to ensure that a fire risk assessment has been conducted to establish fire risks and that appropriate actions are taken to reduce them. Failure to comply could lead to severe legal penalties. Under the Regulatory Reform (Fire Safety) Order 2005, any non-automatic fire fighting equipment should be positioned and signed in accordance with BS EN ISO 7010:2020- to ensure maximum levels of comprehension. By positioning an appropriate fire equipment sign at a height between 1.7m - 2m from the floor it helps to locate and identify essential fire equipment in the event of it being obscured by furnishings in the room.

 <p>WATER</p> <p>SAFE FOR: Wood, paper and textiles</p> <p>NOT FOR: Flammable liquid fires, Live electrical equipment, Flammable METAL fires</p>	<p>1 1214 S 2 1214 S 3 1214 S 4 1214 S 8 1214 S</p> <p>Anodised Aluminium 75 x 200mm 5 9186</p> <p>Brass 75 x 200mm 5 9182</p>	 <p>CARBON DIOXIDE</p> <p>SAFE FOR: Flammable liquids, Live electrical equipment</p> <p>NOT FOR: Wood, paper and textiles, Flammable METAL fires</p>	<p>1 1217 S 2 1217 S 3 1217 S 4 1217 S 8 1217 S</p> <p>Anodised Aluminium 75 x 200mm 5 9184</p> <p>Brass 75 x 200mm 5 9180</p>	 <p>FOAM SPRAY</p> <p>SAFE FOR: Wood, paper and textiles, Flammable liquids</p> <p>NOT FOR: Live electrical equipment, Flammable METAL fires</p>	<p>1 1215 S 2 1215 S 3 1215 S 4 1215 S 8 1215 S</p> <p>Anodised Aluminium 75 x 200mm 5 9183</p> <p>Brass 75 x 200mm 5 9179</p>	 <p>WET CHEMICAL</p> <p>SAFE FOR: Cooking oils and deep fat fires, Wood, paper and textiles, Flammable gases</p> <p>NOT FOR: Flammable liquids, Flammable gases, Live electrical equipment</p>	<p>1 1231 S 2 1231 S 3 1231 S 4 1231 S 8 1231 S</p>	 <p>FOAM BRANCH PIPE</p> <p>SAFE FOR: Wood, paper and textiles, Flammable liquids</p> <p>NOT FOR: Live electrical equipment, Flammable METAL fires</p>	<p>1 1219 S 2 1219 S 3 1219 S 4 1219 S 8 1219 S</p>
---	--	--	--	---	--	--	---	--	---

 <p>MULTI-USE FOAM</p> <p>SAFE FOR: Wood, paper and textiles, Flammable liquids, Cooking oils and deep fat fires</p> <p>NOT FOR: Flammable gases, Flammable METAL fires, Live electrical equipment</p>	<p>1 1249 S 2 1249 S 3 1249 S 4 1249 S</p>	 <p>ABC POWDER</p> <p>SAFE FOR: Wood, paper and textiles, Flammable liquids, Gaseous fires, Live electrical equipment</p>	<p>1 1216 S 2 1216 S 3 1216 S 4 1216 S 8 1216 S</p>	 <p>L2 POWDER</p> <p>SAFE FOR: METAL fires (Inc. Lithium)</p> <p>NOT FOR: Wood, paper and textiles, Flammable liquids, Flammable gases</p>	<p>1 1242 S 2 1242 S 3 1242 S 4 1242 S 8 1242 S</p>	 <p>ALCOHOL RESISTANT FOAM</p> <p>SAFE FOR: Wood, paper and textiles, Flammable liquids</p> <p>NOT FOR: Live electrical equipment, Flammable METAL fires</p>	<p>1 1244 S 2 1244 S 3 1244 S 4 1244 S 8 1244 S</p>	 <p>WATER MIST</p> <p>SAFE FOR: Wood, paper and textiles, Flammable liquids, Gaseous fires, Cooking oils and deep fat fires, Live electrical equipment</p>	<p>1 1257 S 2 1257 S 3 1257 S 4 1257 S 8 1257 S</p>
--	--	--	---	--	---	---	---	---	---

 <p>WATER</p> <p>SAFE FOR: Wood, paper and textiles</p> <p>NOT FOR: Live electrical equipment, Flammable liquids, Flammable METAL fires</p>	<p>1 1237 DE 2 1237 DE 3 1237 DE 4 1237 DE 8 1237 DE</p> <p>Frosted Acrylic 200 x 150mm 5 1237</p> <p>Photolum Acrylic 200 x 150mm 5 1253</p> <p>Anodised Aluminium 200 x 150mm 5 9485</p> <p>Brass 200 x 150mm 5 9484</p>	 <p>CARBON DIOXIDE</p> <p>SAFE FOR: Live electrical equipment</p> <p>NOT FOR: Wood, paper and textiles, Flammable METAL fires</p>	<p>1 1235 DE 2 1235 DE 3 1235 DE 4 1235 DE 8 1235 DE</p> <p>Frosted Acrylic 200 x 150mm 5 1235</p> <p>Photolum Acrylic 200 x 150mm 5 1254</p> <p>Anodised Aluminium 200 x 150mm 5 9487</p> <p>Brass 200 x 150mm 5 9486</p>	 <p>ABC POWDER</p> <p>SAFE FOR: Gaseous fires, Live electrical equipment</p>	<p>1 1233 DE 2 1233 DE 3 1233 DE 4 1233 DE 8 1233 DE</p> <p>Frosted Acrylic 200 x 150mm 5 1233</p> <p>Photolum Acrylic 200 x 150mm 5 1256</p> <p>Anodised Aluminium 200 x 150mm 5 9491</p> <p>Brass 200 x 150mm 5 9490</p>	 <p>FOAM SPRAY</p> <p>SAFE FOR: Wood, paper and textiles, Flammable liquids</p> <p>NOT FOR: Live electrical equipment, Flammable METAL fires</p>	<p>1 1234 DE 2 1234 DE 3 1234 DE 4 1234 DE 8 1234 DE</p> <p>Frosted Acrylic 200 x 150mm 5 1234</p> <p>Photolum Acrylic 200 x 150mm 5 1255</p> <p>Anodised Aluminium 200 x 150mm 5 9489</p> <p>Brass 200 x 150mm 5 9488</p>	 <p>P50 FOAM SPRAY</p> <p>SAFE FOR: Wood, paper and textiles, Flammable liquids, Live electrical equipment up to 1kV at a minimum distance of 1m</p> <p>NOT FOR: Flammable METAL fires</p>	<p>1 1119 S 2 1119 S 3 1119 S 4 1119 S</p>
--	--	---	--	---	--	--	--	--	--

 <p>ALCOHOL RESISTANT FOAM</p> <p>SAFE FOR: Wood, paper and textiles, Flammable liquids</p> <p>NOT FOR: Live electrical equipment, Flammable METAL fires</p>	<p>1 1245 D 2 1245 D 3 1245 D 4 1245 D 8 1245 D</p>	 <p>WATER MIST</p> <p>SAFE FOR: Wood, paper and textiles, Flammable liquids, Gaseous fires, Cooking oils and deep fat fires, Live electrical equipment</p>	<p>1 1257 DE 2 1257 DE 3 1257 DE 4 1257 DE 8 1257 DE</p>	 <p>L2 POWDER</p> <p>SAFE FOR: METAL fires (Inc. Lithium)</p> <p>NOT FOR: Wood, paper and textiles, Flammable liquids, Flammable gases</p>	<p>1 1241 D 2 1241 D 3 1241 DE 4 1241 D 8 1241 D</p>	 <p>HYDRO SPRAY</p> <p>SAFE FOR: Wood, paper and textiles, Flammable liquids</p> <p>NOT FOR: Live electrical equipment, Flammable METAL fires</p>	<p>1 1240 DS 2 1240 D 3 1240 DES 4 1240 DE 8 1240 DE</p>	 <p>WET CHEMICAL</p> <p>SAFE FOR: Cooking oils and deep fat fires, Wood, paper and textiles, Flammable liquids</p> <p>NOT FOR: Flammable gases, Live electrical equipment, Flammable METAL fires</p>	<p>1 1236 D 2 1236 D 3 1236 D 4 1236 D 8 1236 D</p>
---	---	--	--	---	--	---	--	--	---

 <p>P50 FOAM SPRAY</p> <p>SAFE FOR: Wood, paper and textiles, Flammable liquids, Live electrical equipment up to 1kV at a minimum distance of 1m</p> <p>NOT FOR: Flammable METAL fires</p>	<p>1 1119 DE 2 1119 DE 3 1119 DE 4 1119 DE</p>	 <p>MULTI-USE FOAM</p> <p>SAFE FOR: Wood, paper and textiles, Flammable liquids, Cooking oils and deep fat fires</p> <p>NOT FOR: Flammable gases, Flammable METAL fires, Live electrical equipment</p>	<p>1 1249 D 2 1249 D 3 1249 D 4 1249 D</p>	<h4>Extinguisher Information Board</h4> <p>Display this sign in communal areas. Do not place directly above extinguishers.</p>						 <p>Types of Modern Fire Extinguishers</p> <p>WATER, FOAM SPRAY, ABC POWDER, CARBON DIOXIDE, WET CHEMICAL, HYDRO SPRAY</p> <p>SAFE FOR: Wood, paper and textiles, Flammable liquids, Live electrical equipment, Gaseous fires, Cooking oils and deep fat fires, METAL fires (Inc. Lithium)</p> <p>NOT FOR: Flammable gases, Live electrical equipment, Flammable METAL fires, Flammable liquids, Flammable gases, Live electrical equipment, Flammable METAL fires</p>	<p>1 1226 L 2 1226 L 3 1226 L 4 1226 L</p>
---	--	--	--	--	--	--	--	--	--	---	--

Fire Safety Signs

Fire Hose Signs

Supplied ready to peel and apply.
Roll of 100 Labels
Self Adhesive Vinyl
100 x 100mm
5 9702

1 1007 **EK**
2 1007 **E**
3 1007 **E**
4 1007 **E**

1 1221 **S**
2 1221 **S**

1 1024 **G**
2 1024 **G**

2 1016 **C**

1 1019 **C**
2 1019 **C**

1 1221 **D**
2 1221 **D**
3 1221 **DE**
4 1221 **E**

1 1072 **E**
2 1072 **E**
3 1072 **E**
4 1072 **E**

1 1073 **E**
2 1073 **E**
3 1073 **E**
4 1073 **E**

Fire Warden / Marshal Signs

1 1034 **G**

1 1061 **G**

1 1036 **E**
2 1036 **E**

1 1037 **E**
2 1037 **E**

Adapt-a-Sign
Holds A4 Sheet
215 x 310mm
5 1037

Adapt-a-Sign
Holds A4 Sheet
215 x 310mm
5 6079

Adapt-a-Signs enable you to update details easily. See page 88 for more info

1 1053 **H**
2 1053 **H**

Adapt-a-Sign
Holds A4 Sheet
215 x 310mm
5 1053

1 1052 **H**
2 1052 **H**

Adapt-a-Sign
Holds A4 Sheet
215 x 310mm
5 1052

1 1035 **E**
2 1035 **E**

Adapt-a-Sign
Holds A4 Sheet
215 x 310mm
5 1035

1 1063 **E**
2 1063 **E**

1 1060 **E**
2 1060 **E**

1 1065 **H**
2 1065 **H**

1 1064 **H**
2 1064 **H**

1 1062 **E**
2 1062 **E**

Fire Point Signs

1 1014 **EK**
2 1014 **EK**
3 1014 **EK**
4 1014 **EK**
7 1014 **EK**
8 1014 **EK**

Fine Line Marker Pen
Permanent black marker pen with a 0.6mm line width
5 3430

1 1048 **H**

1 1049 **H**

1 1032 **EK**
2 1032 **EK**

Projecting Sign

Identify the location of a fire point from several viewing angles with this double sided projecting sign. Available ready to install in Rigid Plastic or Ultra Bright Photoluminescent Rigid Plastic.

Each Face: 150 x 200mm

Rigid Plastic | Photo Rigid
5 8004 | 5 8013

1 1026 **GL**
2 1026 **GL**

1 1021 **C**
2 1021 **C**

Directional Indicator

Supplementary arrows may be used in combination with fire safety signs to communicate the location of equipment. To avoid confusion with directional emergency escape signs, ISO 7010 fire exit arrows should not be used to indicate the direction of equipment.

1 1104 **ADS**
2 1104 **ADS**
3 1104 **ADS**
4 1104 **ADS**

Fire Door Signs

A fire door's purpose is to enable an emergency escape route through a property whilst compartmentalising a fire and preventing the spread of smoke and flames. This range of signs highlights a fire door and advises of its proper use.

1 1077 **EK**
2 1077 **EK**

1 1078 **EK**
2 1078 **EK**

1 1076 **EK**
2 1076 **EK**

1 1075 **EK**
2 1075 **EK**

Fire Alarm Signs



- 1 1017 BCU
- 2 1017 BCU
- 3 1017 CU
- 4 1017 CU
- 8 1017 CU

Anodised Aluminium
175 x 175mm
5 9105

Brass
175 x 175mm
5 9104



- 1 1010 EK Braille
- 2 1010 EK 150 x 225mm
- 3 1010 EK 5 6178
- 4 1010 E
- 7 1010 EK
- 8 1010 EK



- 1 1011 EK
- 2 1011 EK
- 3 1011 EK
- 4 1011 E
- 8 1011 EK



- 1 1031 X
- 2 1031 X
- 3 1031 X
- 4 1031 X



- 1 1002 X
- 2 1002 X



- 1 1025 GL



- 1 1079 BCGLUEK
- 2 1079 BCGLUEK
- 3 1079 BCGLUEK
- 4 1079 BCGLUEK



- 1 1041 B
- 2 1041 B



- 1 1040 GL

Rolls of Labels



Supplied ready cut to peel off and apply.

Roll of 100 Self Adhesive Vinyl
100 x 100mm
5 9701



- 1 1039 E



- 1 1051 H

Enables you to update details easily. See page 88.

More multi-lingual signs like this one on page 65.

Adapt-a-Sign



3mm PVC
215 x 310mm
5 1043

English & Polish



- 1 1057 E
- 2 1057 E

Projecting Signs



To identify locations of fire alarms from several viewing angles.

Rigid Plastic
Face: 150 x 200mm
5 8003

Photo Rigid
Face: 150 x 200mm
5 8009

Desktop Sign



Ideal for reception areas to inform of planned fire alarm tests. Write the time of the test in the space and display when required.

3mm Acrylic
Face: 300 x 210mm
5 8062

Extinguishing Equipment



- 1 1218 S
- 2 1218 S
- 3 1218 S
- 4 1218 S
- 8 1218 S

Anodised Aluminium
75 x 200mm
5 9185

Brass
75 x 200mm
5 9181



- 1 1246 DE
- 2 1246 DE
- 3 1246 DE
- 4 1246 DE
- 8 1246 DE



- 1 1204 S
- 2 1204 S



- 1 1012 E
- 2 1012 E



- 1 1068 E



- 1 1067 EK
- 2 1067 EK

Projecting Sign

Identify locations of fire fighting equipment with this projecting sign.



Rigid Plastic
Face: 150 x 200mm
5 8040



- 1 1027 E
- 2 1027 E



- 1 1103 E
- 2 1103 E



- 1 1105 E
- 2 1105 E



- 1 1107 E
- 2 1107 E



- 1 1106 E
- 2 1106 E



- 1 1020 C

Sprinkler Signs

Sprinklers are seen as the only system which detects a fire, suppresses a fire and raises an alarm, making them vitally important as part of a fire safety programme. This range of signs helps identify and highlight the locations of important sprinkler equipment within a building.

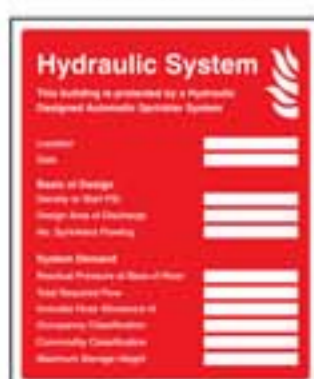

- 1 1452 H
- 2 1452 H



- 1 1451 AE
- 2 1451 AE



- 1 1445 E
- 2 1445 E



- 1 1446 E
- 2 1446 E



- 1 1447 E
- 2 1447 E



- 1 1449 E
- 2 1449 E

BS3251 Hydrant Marker

Manufactured to BS3251 from non-fade, durable injection moulded plastic. Information is displayed using snap fit, anti vandal number inserts.

6 x numbers / blank tiles supplied with each marker plate - please specify when ordering. Fixing screws not included.



180 x 205mm
5 1209

Cut Out Numbers (0-9)



25mm (H) - Self Adhesive Vinyl
Black 5 8201 | White 5 8202

Budget Hydrant Marker

Economical temporary hydrant marker

178 x 203mm
Rigid Plastic
5 1212



Material Codes

- 1 Rigid Plastic
- 2 Self Adhesive Vinyl
- 3 Photolum Rigid Plastic
- 4 Photolum Self Adhesive
- 7 PET
- 8 Quick Fix

Landscape Sizes

- B 80 x 80mm
- C 150 x 150mm
- D 150 x 100mm
- E 200 x 150mm

Portrait Sizes

- G 300 x 100mm
- H 300 x 250mm
- I 450 x 150mm
- J 400 x 300mm
- K 300 x 400mm
- L 100 x 100mm
- M 75 x 100mm
- N 150 x 200mm
- O 250 x 300mm
- P 100 x 150mm
- Q 75 x 200mm
- R 100 x 200mm

Residential Fire Action

Houses of multiple occupancy (HMO) have strict regulations for fire safety and must always have a fire action plan in place.



1 1438 **EH** *Stay put policy
 2 1438 **EH**
 3 1438 **EH**
 4 1438 **EH**
 8 1438 **EH**

DM
LIFT



1 1414 **EH**
 2 1414 **EH**
 3 1414 **EH**
 4 1414 **EH**
 8 1414 **EH**

DM



1 1408 **EH** Anodised Aluminium
 2 1408 **EH** 150 x 200mm
 3 1408 **EH** 5 9528
 4 1408 **EH** Brass
 8 1408 **EH** 150 x 200mm
 5 9529

DA
LIFT



1 1423 **EH** Adapt-a-Sign
 2 1423 **EH** Holds A4 Sheet
 3 1423 **EH** 215 x 310mm
 4 1423 **EH** 5 1423
 8 1423 **EH**

DM



1 1415 **EH**
 2 1415 **EH**



1 1418 **EH**
 2 1418 **EH**
 3 1418 **E**
 4 1418 **E**

DM
LIFT



1 1416 **EH**
 2 1416 **EH**
 3 1416 **E**
 4 1416 **E**

DM



1 1432 **EH** Adapt-a-Sign
 2 1432 **EH** Holds A4 Sheet
 3 1432 **EH** 215 x 310mm
 4 1432 **EH** 5 1432
 8 1432 **EH**

DM
LIFT

Multi-Lingual Fire Action Signs



1 1437 **EH**
 2 1437 **EH**
 3 1437 **EH**

DA



1 1435 **EH**
 2 1435 **EH**
 3 1435 **EH**

DA
LIFT



1 1424 **H**
 2 1424 **H**

DM
LIFT



1 1441 **EH**
 2 1441 **EH**



1 1440 **EH**
 2 1440 **EH**
 3 1440 **E**
 4 1440 **E**

DA
LIFT



1 1436 **E**
 2 1436 **E**
 3 1436 **EH**
 4 1436 **E**

DM
LIFT



1 1430 **EH**
 2 1430 **EH**
 3 1430 **EH**



1 1431 **EH**
 2 1431 **E**
 3 1431 **E**

DM

Fire Action Signs

Legislation requires that all staff and visitors are aware of the fire procedure for work premises. Fire action signs advise the actions to be taken in case of fire.



Staff Fire Action Routine

- Operate nearest fire alarm point
- Call the Fire Brigade
- Fight the fire, if safe and trained to do so
- Evacuate the building via the nearest exit
- Do not stop to collect personal belongings

1 1439 **EH**
2 1439 **EH**
3 1439 **EH**
4 1439 **EH**
8 1439 **EH**

DM

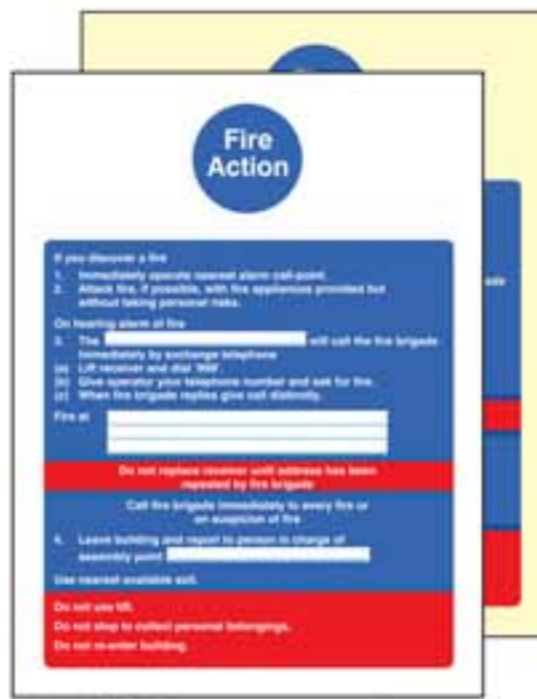

Fire Action

If you discover a fire:

- Immediately operate nearest alarm call point.
- Attack fire, if possible, with the equipment provided but without taking personal risks.

On hearing alarm of fire:

- The [] will call the fire brigade immediately by exchange telephone.
- Lift nearest and shut 'off'.
- Give operator your telephone number and ask for the []
- When the fire brigade replies give call details.

Fire at []

Do not replace nearest call address has been reported by fire brigade.

Call the brigade immediately to every fire or on suspicion of fire.

Leave building and report to person in charge of assembly point.

Use nearest available exit.

Do not use lifts.

Do not stop to collect personal belongings.

Do not re-enter building.

1 1402 **EH**
2 1402 **EH**
3 1402 **EH**
4 1402 **E**
8 1402 **E**

DM
LIFT



Fire Action

If you discover fire:

- Immediately operate nearest alarm call point.

On hearing alarm of fire:

- The [] will call the fire brigade.
- Do not stop to collect personal belongings.
- Leave by nearest available exit.
- Proceed to assembly point situated at [] and report to person in charge.

Do not use lifts.

Do not re-enter building until you are told it is safe to do so.

1 1403 **EH**
2 1403 **EH**
3 1403 **EH**
4 1403 **E**
8 1403 **E**

DM
LIFT



Fire Action

- Operate nearest fire alarm.
- Leave building by the nearest exit.
- Report to assembly point.

1 1405 **EH**
2 1405 **EH**
3 1405 **EH**
4 1405 **EH**
7 1405 **EH**
8 1405 **E**

DM

* For caravan sites



Fire Action

On discovering a fire:-

- Ensure the caravan or site building involved is evacuated.
- Raise the alarm.
- Call the fire brigade. The nearest telephone is sited []
- Attack the fire using the fire fighting equipment provided.

It is the interest of all occupiers of the site to be familiar with the above routine and the method of operating the fire alarm and fire fighting equipment.

1 1404 **E**
2 1404 **E**

DM



In case of fire

If you discover a fire:

- Remove the fire alarm by breaking the glass. The alarm will sound automatically.
- Call the fire brigade. The nearest telephone is sited []
- Use the fire equipment provided and ask for the Fire Brigade.
- When the Fire Brigade arrives say details:-

Fire at []

Do not put the nearest alarm out and fire brigade have reported the address.

1 1422 **E**
2 1422 **E**

DM

* For car parks



Fire Action

- Call Fire Brigade immediately
- Proceed to nearest available exit
- Do not return to your vehicle

1 7565 **Q**

DM



Fire Action

- Lift nearest and shut 'off'.
- Give operator your telephone number and ask for the []
- When the fire brigade replies give call details.

Fire at []

Do not replace nearest call address has been reported by fire brigade.

Call the brigade immediately to every fire or on suspicion of fire.

1 1406 **F**
2 1406 **F**

DM

2 in 1 - Fire Action & Call Point Symbol

These 2 in 1 signs are designed with an aperture to accommodate regulation size fire alarm call points, simply pop out the call point symbol and apply the main sign over the call point alarm box then position the "popped out" symbol on the wall above the alarm at a height of between 1.7 and 2 metres from the floor. Self Adhesive Photoluminescent - Fire Action: 150 x 330mm - Call Point Symbol: 100 x 100mm



5 8220 **DA**



5 8221 **DA** **LIFT**



5 8222 **DM** **LIFT**



5 8223 **DM**



5 8224 **DM**



5 8225 **DM** **LIFT**



5 1079 **DA**



Lift Warnings



1 2085 **EH**
2 2085 **EH**



1 1213 **EH**
2 1213 **EH**
3 1213 **E**
4 1213 **E**
8 1213 **E**



1 1220 **EH**
2 1220 **EH**
3 1220 **E**
4 1220 **E**
8 1220 **E**



1 1248 **EH**
2 1248 **EH**
3 1248 **EH**
4 1248 **EH**
8 1248 **EH**

Fire Action Key:

LIFT Lift in the Building

DA Fire Service Dialed Automatically

DM Fire Service Dialed Manually

Material Codes

1 Rigid Plastic
2 Self Adhesive Vinyl

3 Photoluminescent Rigid Plastic
4 Photoluminescent Self Adhesive

5 Miscellaneous
7 PET
8 Quick Fix

Landscape Sizes

E 200 x 150mm **F** 200 x 200mm **Q** 600 x 450mm

Portrait Sizes

E 150 x 200mm **H** 250 x 300mm

Fire Action Signs



1 1419 **EH** Anodised Aluminium **DM**
 2 1419 **EH** 150 x 200mm
 3 1419 **EH** 5 9538 **LIFT**
 4 1419 **EH** Brass
 8 1419 **EH** 150 x 200mm
 5 9539



1 1420 **EH** Rigid Plastic **DM**
 2 1420 **EH** A5 (148 x 210mm)
 3 1420 **EH** 5 8318
 4 1420 **EH** Self Adhesive Vinyl
 8 1420 **E** A5 (148 x 210mm)
 5 8319



1 1428 **EH** **DA**
 2 1428 **EH** **LIFT**
 3 1428 **EH**
 4 1428 **EH**
 8 1428 **EH**



1 1429 **EH** **DA**
 2 1429 **EH**
 3 1429 **EH**
 4 1429 **EH**
 7 1429 **EH**
 8 1429 **E**



1 1427 **EH** **DM**
 2 1427 **EH**
 3 1427 **EH**
 4 1427 **E**
 8 1427 **E**



1 1426 **EH** **DM**
 2 1426 **EH** **LIFT**
 3 1426 **EH**
 4 1426 **EH**
 8 1426 **EH**

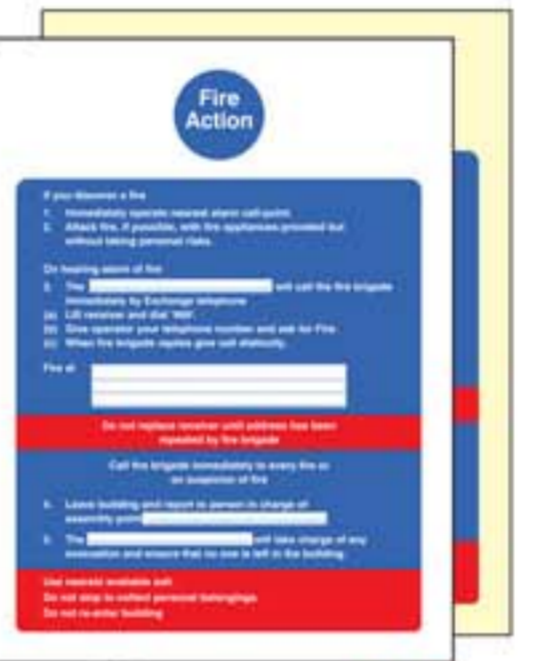

1 1401 **EH** **DM**
 2 1401 **EH**
 3 1401 **EH**
 4 1401 **E**
 8 1401 **EH**

Fire Door Inspection Record

It is recommended that fire doors in flats be routinely checked at least every three-months to ensure they are in good working order.

Place this next to fire doors and update throughout the year. See page 88 for more Adapt-a-Signs.

Date	Inspected by	Comments

1 1108 **K** Adapt-a-Sign
 2 1108 **K** 215 x 310mm
 5 1108

Peel & Stick Labels



Self adhesive labels are supplied ready cut to peel off and apply. If you cannot find the label you need we will be happy to quote for your requirements. Contact our sales desk for further details.



Self Adhesive Vinyl
 Roll of 100 - 100mm Square
 5 9704



Self Adhesive Vinyl
 Roll of 100 - 100mm Square
 5 9703



Self Adhesive Vinyl
 Roll of 100 - 100mm Square
 5 9705



Self Adhesive Vinyl
 6 x 65mm Dia
 5 1679



Self Adhesive Vinyl
 6 x 65mm Dia
 5 1680



Self Adhesive Vinyl
 6 x 65mm Dia
 5 1681



Self Adhesive Vinyl
 6 x 65mm Dia
 5 1637



Photoluminescent
 6 x 80mm Square
 5 9690



Self Adhesive Vinyl
 6 x 65mm Dia
 5 1660

Deluxe Fire Door Signs

These deluxe fire door signs are ideal for environments requiring a high quality finish. 76mm Dia - Fixings included - Pre drilled



Aluminium 5 9128
 Brass 5 9122
 Stainless Steel 5 9125









Aluminium 5 9129
 Brass 5 9123
 Stainless Steel 5 9126















Aluminium 5 9130
 Brass 5 9124
 Stainless Steel 5 9127



Fire Door Signs

Every fire door should have a "Fire door Keep shut" sign fitted. When doors can be used from both sides a sign is required on both sides. Doors that open on to a fire escape corridor should be locked shut and signed accordingly. The window stickers are all double sided and designed for use on glass doors. They ensure the message is visible from both directions.

					
<p>1 1610 BU Anodised Aluminium 70 x 70mm 2 1610 BU Anodised Aluminium 70 x 70mm 3 1610 B 4 1610 B 7 1610 B 8 1610 B</p> <p>Window Sticker 100 x 100mm 5 9247</p>	<p>1 1606 BFN Window Sticker 100 x 100mm 2 1606 BFN Window Sticker 100 x 100mm 3 1606 BF 4 1606 BF 7 1606 F 8 1606 B</p>	<p>1 1605 FNU Window Sticker 100 x 100mm 2 1605 FNU Window Sticker 100 x 100mm 3 1605 B 4 1605 B 7 1605 BF 8 1605 BF</p>	<p>1 1618 BU Anodised Aluminium 70 x 70mm 2 1618 BU Anodised Aluminium 70 x 70mm 3 1618 B 4 1618 B 7 1618 B 8 1618 B</p>	<p>1 1616 B 2 1616 B 3 1616 B 4 1616 B 8 1616 B</p>	<p>1 1635 U 2 1635 U 3 1635 B 4 1635 B 7 1635 B 8 1635 U</p>

					
<p>1 1621 B 2 1621 B 3 1621 B 4 1621 B 8 1621 B</p>	<p>1 1608 BF 2 1608 BF 3 1608 B 4 1608 B</p>	<p>1 1611 B 2 1611 B 3 1611 B 4 1611 B</p>	<p>1 1609 B Anodised Aluminium 70 x 70mm 2 1609 B Anodised Aluminium 70 x 70mm 8 1609 B</p>	<p>1 1054 B 2 1054 B</p>	<p>1 1612 B 2 1612 B</p>

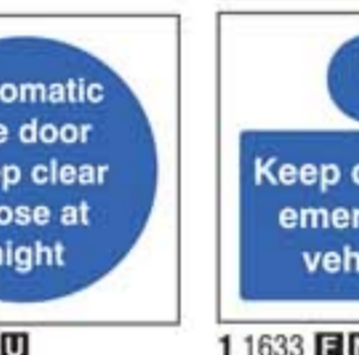
					
<p>1 1636 U 2 1636 U</p>	<p>1 1613 FN 2 1613 FN</p>	<p>1 1601 F 2 1601 F</p>	<p>1 1623 BF 2 1623 BF</p>	<p>1 1602 BF 2 1602 BF</p>	<p>1 1604 FN 2 1604 FN</p>

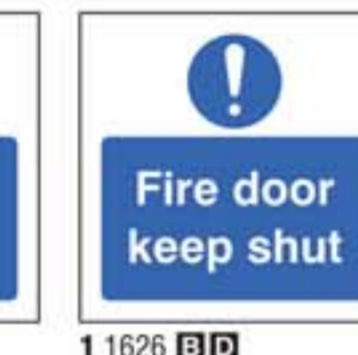
					
<p>1 1619 B 2 1619 B 7 1619 B</p>	<p>1 1614 F 2 1614 F</p>	<p>1 1617 BU 2 1617 BU</p>	<p>1 1633 FN</p>	<p>1 1625 B 2 1625 B</p>	<p>1 1626 BD 2 1626 BD</p>

				
<p>Rigid Plastic A4 (210 x 297mm) 5 8362</p> <p>Self Adhesive Vinyl A4 (210 x 297mm) 5 8363</p>	<p>Rigid Plastic A4 (210 x 297mm) 5 8396</p> <p>Self Adhesive Vinyl A4 (210 x 297mm) 5 8397</p>	<p>1 1632 FN 2 1632 FN</p>	<p>1 1649 FN 2 1649 FN</p>	<p>1 1628 B 2 1628 B</p>

			
<p>Self Adhesive Pads Pack of 4 5 8724</p>	<p>1 1634 F 2 1634 F</p>	<p>1 1629 BD 2 1629 BD</p>	<p>1 1630 B 2 1630 B</p>

Fire Door Edge Signs

Do not place a fire door edge sign over a fire door's intumescent strip.



Self Adhesive Vinyl 45 x 400mm

		
5 1638	5 1642	5 1643

Fire Action Key:

- LIFT** Lift in the Building
- DA** Fire Service Dialed Automatically
- DM** Fire Service Dialed Manually

Material Codes

- 1 Rigid Plastic
- 2 Self Adhesive Vinyl
- 3 Photoluminescent Rigid Plastic
- 4 Photoluminescent Self Adhesive
- 5 Miscellaneous
- 7 PET
- 8 Quick Fix

Landscape Sizes

- B** 80 x 80mm
- D** 150 x 100mm
- F** 200 x 200mm
- K** 400 x 300mm
- N** 400 x 400mm
- U** 100 x 100mm

Portrait Sizes

- E** 150 x 200mm
- H** 250 x 300mm

Fire Extinguisher Location Boards

Extinguisher brackets (*not supplied) should be fixed through the panel and onto the wall



3mm Foam PVC
300 x 800mm
5 1028

Select the relevant Extinguisher ID sign (size **D** on page 6) and apply to top of board in the space provided.

Sign of choice should be ordered separately.



3mm Photolum Foam
300 x 800mm
5 1029



3mm Foam
900 x 900mm
5 8020

Specify the required fire extinguisher IDs when ordering.



450 x 900mm - 3mm Foam
Water 5 8014 ABC 5 8016
Foam 5 8015 Co2 5 8017



Fire Extinguisher Location Stand

This stand suits all types of extinguishers.

The design allows multiple stands to be interlinked together.

Includes smooth mounting area for fire extinguisher ID signs - sold separately.

Supplied in a two part flat pack.

*Available in grey on request

Shatterproof Polypropylene
295W x 270D x 665Hmm
5 8200



Fire Safety Signs Kit

Our most popular fire safety signs in a kit. Ideal for new builds or a freshen up.

Rigid Plastic

- 2 x Fire alarm (300 x 100mm)
- 3 x Fire exit - Left (300 x 100mm)
- 3 x Fire exit - Right (300 x 100mm)
- 3 x EEC Fire action (150 x 200mm)
- 3 x Fire extinguisher (300 x 100mm)
- 2 x Push bar to open (300 x 100mm)
- 1 x Fire assembly point (450 x 600mm)
- 2 x Your assembly point is (150 x 50mm)
- 2 x Fire exit - Straight on (300 x 100mm)
- 2 x Fire exit - Keep clear (300 x 100mm)

Self Adhesive Vinyl

- 18 x Fire door keep closed (65mm Dia)

5 1724



Fire Log Book

Maintaining a fire log book demonstrates that fire safety responsibilities are being managed within the workplace. It also provides fire engineers with dates and times of service history and ensures compliance with BS 5839-1: 2017.



5 8061

Includes contents / logs for:

- User responsibilities
- Premises details
- Fire fighting equipment
- Hose reels
- Fire alarm testing
- Alarm activations
- Fire alarm servicing
- Fire alarm system certification
- Emergency lighting
- Fire doors and escape route inspection
- Fire instructions and drills

Fire Log Book Holder

This wall mountable station ensures that fire log books are clearly visible at all time and is easy to access by fire engineers needing to view service history. The station helps to overcome the log book being misplaced or not close to hand. The station is pre-drilled for easy mounting and includes a printed "missing" message to show if / when the log book has been removed.

3mm Rigid Plastic
360 x 220 x 15mm
5 8203



Fire Document Holder

Keep important fire safety documents clearly displayed and readily available in a central location.

This sign comes with a durable polystyrene document holder for storing A4 ring binders and folders.

440 x 600mm
10mm Foam Board
5 8213

Full range of document holding signs on page 45.



Fire Safety Posters

Eye catching safety posters made on wipe-clean synthetic paper.



Synthetic Paper
510 x 760mm
5 9820



Synthetic Paper
510 x 760mm
5 8189

Reflective Armbands

Enable staff and visitors to quickly identify fire personnel.

Adjustable hook and loop fastening. One size fits all, can be adjusted to fit 90 - 130mm dia.



Fire Warden
5 6448

Fire Marshal
5 6449

Glow Sticks

Simply bend the glow stick until you feel and hear the internal vessel snap, then shake until it emits a bright glow (glows for approx. 12 hrs). Supplied with suspension cord to wear around the neck. 150mm Long



Green 5 8586 Red 5 8587 Blue 5 8588

Directional Emergency Escape Signs

Emergency escape signs are designed to guide you from wherever you are in a building, via a place of relative safety (the escape route) to the place of ultimate safety (the assembly area). It must not be assumed that everyone will know all safe routes through the building. Emergency escape signs should comply with BS EN ISO 7010:2020 to ensure maximum levels of understanding. The old EC Directive (92/58/EEC) designs should no longer be used due to their low comprehension credentials.

We have a range of emergency escape signs available in photoluminescent materials (signs which start with a **3** or **4**).

The strength and quality of photoluminescent materials can vary greatly between manufacturers and for this reason we have introduced the Ultra Bright brand to give assurance that all our photoluminescent signage exceeds PSPA (The Photoluminescent Safety Products Association) Class C ratings, making it one of the best in the UK market and ensuring our signs stay brighter for longer to give the maximum chance for a successful evacuation (see page 5 for details).

Ensuring that signage is clearly visible in blackout conditions can prove the difference between life and death during an emergency evacuation, helping guide people to exits and to essential equipment in an emergency situation where a mains failure has occurred. Ultra Bright signs will help lead the way to safety even in smoky conditions.



<p>1 2004 GLM 2 2004 GLM 3 2004 GLM 4 2004 GLM 7 2004 GL 8 2004 GL</p> <p>Rigid Plastic A4 (297 x 210mm) 5 8390</p> <p>Self Adhesive Vinyl A4 (297 x 210mm) 5 8391</p> <p>5mm Foam PVC 1200 x 400mm 5 2138</p> <p>Anodised Aluminium 300 x 100mm 5 5923</p> <p>Photolum PVC 900 x 300mm 5 2126</p> <p>Brass 300 x 100mm 5 9517</p> <p>Floor Graphic 600 x 200mm 5 8815</p> <p>Braille 450 x 150mm 5 6186</p>	<p>1 2003 GLM 2 2003 GLM 3 2003 GLM 4 2003 GLM 7 2003 GL 8 2003 GL</p> <p>Rigid Plastic A4 (297 x 210mm) 5 8394</p> <p>Self Adhesive Vinyl A4 (297 x 210mm) 5 8395</p> <p>5mm Foam PVC 1200 x 400mm 5 2128</p> <p>Anodised Aluminium 300 x 100mm 5 5922</p> <p>Photolum PVC 900 x 300mm 5 2124</p> <p>Brass 300 x 100mm 5 9516</p> <p>Floor Graphic 600 x 200mm 5 8813</p> <p>Braille 450 x 150mm 5 6185</p>	<p>1 2007 GLM 2 2007 GLM 3 2007 GLM 4 2007 GLM 7 2007 GL 8 2007 GL</p> <p>Rigid Plastic A4 (297 x 210mm) 5 8388</p> <p>Self Adhesive Vinyl A4 (297 x 210mm) 5 8389</p> <p>5mm Foam PVC 1200 x 400mm 5 2129</p> <p>Anodised Aluminium 300 x 100mm 5 5925</p> <p>Photolum PVC 900 x 300mm 5 2125</p> <p>Brass 300 x 100mm 5 9519</p> <p>Floor Graphic 600 x 200mm 5 8811</p> <p>Braille 450 x 150mm 5 6187</p>	<p>1 2008 GLM 2 2008 GLM 3 2008 GLM 4 2008 GLM 7 2008 GL 8 2008 GL</p> <p>Rigid Plastic A4 (297 x 210mm) 5 8392</p> <p>Self Adhesive Vinyl A4 (297 x 210mm) 5 8393</p> <p>5mm Foam PVC 1200 x 400mm 5 2139</p> <p>Anodised Aluminium 300 x 100mm 5 5924</p> <p>Braille 450 x 150mm 5 6199</p> <p>Brass 300 x 100mm 5 9518</p>
<p>1 2001 GLM 2 2001 GLM 3 2001 GL 4 2001 GL 8 2001 GL</p>	<p>1 2005 GLM 2 2005 GLM 3 2005 GLM 4 2005 GL 8 2005 GL</p>	<p>1 2002 GLM 2 2002 GLM 3 2002 GL 4 2002 GL 8 2002 GL</p>	<p>1 2006 GLM 2 2006 GLM 3 2006 GLM 4 2006 GL 8 2006 GL</p>
<p>1 2012 GLM 2 2012 GLM 3 2012 GLM 4 2012 GLM 8 2012 GL</p> <p>PVC Banner 1270 x 610mm Includes Eyelets 5 2012</p>	<p>1 2010 GLM 2 2010 GL 3 2010 GL 4 2010 GL</p>	<p>1 2014 GLM 2 2014 GL 3 2014 GLM 4 2014 GL</p>	<p>1 2016 GLM 2 2016 GLM 3 2016 GLM 4 2016 GLM 8 2016 GL</p>
<p>1 2011 GLM 2 2011 GLM 3 2011 GLM 4 2011 GLM 8 2011 GL</p> <p>PVC Banner 1270 x 610mm Includes Eyelets 5 2011</p>	<p>1 2009 GLM 2 2009 GL 3 2009 GL 4 2009 GL</p>	<p>1 2013 GLM 2 2013 GL 3 2013 GLM 4 2013 GL</p>	<p>1 2015 GLM 2 2015 GLM 3 2015 GLM 4 2015 GLM 8 2015 GL</p>
<p>1 2033 JLVX 2 2035 JLVX 3 2033 JLVX 4 2033 JVX 7 2033 V 8 2033 LV</p> <p>Anodised Aluminium 200 x 100mm 5 9527</p> <p>5mm Foam PVC 800 x 400mm 5 2105</p> <p>Photolum PVC 800 x 400mm 5 2127</p> <p>Brass 200 x 100mm 5 9521</p> <p>Floor Graphic 400 x 200mm 5 8809</p>	<p>1 2056 JVX 2 2056 JVX 3 2056 JVX 4 2056 JVX 8 2056 V</p> <p>5mm Foam PVC 800 x 400mm 5 2106</p>	<p>1 2057 JVX 2 2057 JVX 3 2057 JVX 4 2057 JVX</p>	<p>1 2036 JLVX 2 2036 JLVX 3 2036 JLVX 4 2036 JVX</p>

Material Codes

- 1 Rigid Plastic
- 2 Self Adhesive Vinyl
- 3 Photoluminescent Rigid Plastic
- 4 Photoluminescent Self Adhesive
- 5 Miscellaneous
- 7 PET
- 8 Quick Fix

Landscape Sizes

- G 300 x 100mm
- J 400 x 200mm
- L 450 x 150mm
- M 600 x 200mm
- V 300 x 150mm
- X 200 x 100mm

Emergency Escape Signs



- 1 2062 GL Floor Graphic 600 x 200mm
- 2 2062 GL 5 8807
- 3 2062 GL
- 4 2062 GL Double Sided Sticker 300 x 100mm
- 8 2062 GL 5 8255



- 1 2047 GL
- 2 2047 GL
- 3 2047 GL
- 4 2047 GL
- 8 2047 GL



- 1 2052 GL Aluminium 300 x 100mm
- 2 2052 GL 5 5926
- 3 2052 GL
- 4 2052 GL
- 8 2052 GL Brass 300 x 100mm
- 5 9520



- 3 2099 J Place behind a push bar so that the blank panel shows the bar location.
- 4 2099 J



- 1 2051 GL
- 2 2051 GL
- 3 2051 GL
- 4 2051 GL



- 1 2049 GL
- 2 2049 GL
- 3 2049 GL
- 4 2049 GL



- 1 2048 GL
- 2 2048 GL
- 3 2048 GL
- 4 2048 GL



- 1 2050 GL
- 2 2050 GL
- 3 2050 GL
- 4 2050 GL



- 1 2061 GL
- 2 2061 GL
- 3 2061 GL
- 4 2061 GL



- 1 2065 GL
- 2 2065 GL
- 3 2065 GL
- 4 2065 GL



- 1 2045 GL
- 2 2045 GL
- 3 2045 G
- 4 2045 G



- 1 2046 GL
- 2 2046 GL
- 3 2046 G
- 4 2046 G



- 1 2072 FU
- 2 2072 FU
- 3 2072 FU
- 4 2072 FU



- 1 2060 FU
- 2 2060 FU
- 3 2060 FU
- 4 2060 FU



- 1 2043 FU
- 2 2043 FU
- 3 2043 FU
- 4 2043 FU



- 1 2044 FU
- 2 2044 FU
- 3 2044 FU
- 4 2044 U



- 1 2034 CFU
- 2 2034 CFU
- 3 2034 CFU
- 4 2034 CU



- 1 2037 CFU
- 2 2037 CFU
- 3 2037 CFU
- 4 2037 CU



- 1 2064 GL
- 2 2064 GL
- 3 2064 GL
- 4 2064 GL



- 1 2039 CF
- 2 2039 CF
- 3 2039 CF
- 4 2039 C



- 1 2040 CF
- 2 2040 CF
- 3 2040 CF
- 4 2040 C



- 1 2038 CF
- 2 2038 CF
- 3 2038 CFU
- 4 2038 CFU



- 1 2035 CF
- 2 2035 CF
- 3 2035 CFU
- 4 2035 C



- 1 2041 F
- 2 2041 F
- 3 2041 F
- 4 2041 F



- 1 2122 F
- 2 2122 F
- 3 2122 F
- 4 2122 F



- 1 2042 F
- 2 2042 F
- 3 2042 F
- 4 2042 F

ISO 7010 regulations state that "text only" signs should be used alongside a running man graphic and, where appropriate, a directional arrow. They should not be used on their own.



- 1 2063 GL
- 2 2063 GL
- 3 2063 GL
- 4 2063 GL



- 1 2069 GL
- 2 2069 GL
- 3 2069 GL
- 4 2069 GL



- 1 2053 GL
- 2 2053 GL
- 3 2053 GL
- 4 2053 GL



- 1 2058 GL
- 2 2058 GL
- 3 2058 GL
- 4 2058 GL



- 1 2070 S
- 2 2070 S



- 1 2071 S
- 2 2071 S



- 1 2067 AE
- 2 2067 AE



- 2 2068 A



- 5 8103 600 x 75mm Self Adhesive Vinyl



Stairway, Floor Level & Dwelling ID Signs

To assist the fire and rescue service in identifying each level of a building, storey identification signs identify the level by "Floor Number" and should be located on every landing of a fire-fighting stairway and every fire-fighting lobby (or open access balcony) into which a fire-fighting lift discharges. Storey ID signs should be supplemented by dwelling indicator signs (positioned directly below the Storey ID sign), which provide information as to the dwellings (flats or maisonettes) located on the storey in question.

 3 2170 L 4 2170 L	 3 2171 L 4 2171 L	 3 2172 L 4 2172 L	
 3 2173 L 4 2173 L	 3 2174 L 4 2174 L	 3 2175 L 4 2175 L	
 3 2177 L 4 2177 L	 3 2178 L 4 2178 L	 3 2176 L 4 2176 L	
 3 2179 L 4 2179 L	 3 2180 L 4 2180 L	 Rigid Plastic Photoluminescent 450 x 150mm 5 2181 Self Adhesive Photoluminescent 450 x 150mm 5 2182	

Please specify the range of flat numbers to be included. (e.g. 1 - 9 or 1A - 5C).

Large Double Sided

5mm Foam PVC - 1200 x 400mm - Ideal for factories / warehouses where lighting may be poor and / or there may be large open areas where emergency escape signs are required to be viewed from a distance. These signs are easily drilled which means you can suspend them from a ceiling using a suspension kit.

 5 2160	 5 2100	 5 2161
---	--	---

Large Photoluminescent Directional

Photoluminescent Rigid Plastic - 900 x 300mm - Easily drilled for wall fixing / suspending from a ceiling

 5 2125	 5 2124	 5 2126
---	--	---

No Escape Sign



1 1624 E
2 1624 E
3 1624 E
4 1624 E

Branded Site Saver Signs

Fluted Polypropylene - 600 x 400mm





Low-cost, lightweight and durable making them perfect for temporary site signage. Add your company logo at no extra cost.

 5 5789	 5 5790	 5 5791	 5 5792
---	--	---	---

Double Sided Stickers

These double sided stickers allow application to the inside of a glass window / door.

 300 x 100mm 5 8255	 300 x 100mm 5 9544
--	---

Sign Suspension Kits

	Hook Suspension Kit Easy attachment of lightweight signs to a ceiling 2 x 150mm Wire Hooks 2 x Self Adhesive Ceiling Buttons 5 8100
	Chain Suspension Kits Polished chain for an impressive ceiling fixing 2 x 500mm Brass Chain 2 x 500mm Chrome Chain 4 x Brass Hooks 4 x Chrome Hooks 2 x Ceiling Buttons 2 x Ceiling Buttons 5 8729 5 8679

Material Codes

- 1 Rigid Plastic 3 Photolum Rigid Plastic 5 Miscellaneous
- 2 Self Adhesive Vinyl 4 Photolum Self Adhesive 8 Quick Fix

Landscape Sizes

- C 150 x 150mm G 300 x 100mm L 450 x 150mm
- F 200 x 200mm J 400 x 200mm U 100 x 100mm

Portrait Sizes

- A 75 x 100mm G 100 x 300mm S 75 x 200mm
- E 150 x 200mm L 150 x 450mm







Emergency Escape Signs

Emergency Escape for Disabled People

This range of signs is specifically designed to assist the safe evacuation of physically disabled people in the event of an emergency. These signs meet the requirements of BS9999:2017 - Code of practice for fire safety in the design, management and use of buildings.





 1 2089 GL 2 2089 GL 3 2089 GL	 1 2087 GL 2 2087 GL 3 2087 GL	 1 2091 GL 2 2091 GL 3 2091 GL	 1 2085 BH 2 2085 BH
 1 1227 GL 2 1227 GL 3 1227 GL	 1 2098 GL 2 2098 GL 3 2098 GL	 1 2147 GL 2 2147 GL 3 2147 L	

Emergency Refuge Signs

 1 2146 GL 2 2146 G 3 2146 GL	 1 2096 BH 2 2096 BH 3 2096 BH	 1 2095 BH 2 2095 BH 3 2095 BH 4 2095 E	 1 1430 BH 2 1430 BH 3 1430 BH	 1 1228 H 2 1228 H
 Braille 300 x 150mm 5 6176	Floor Graphic 400 x 600mm 5 8823			















Inclusive Emergency Escape Signs

This range is a truly inclusive design and an excellent alternative sign solution. Although not currently ISO 7010 registered the combined 'Running Man' and 'Man Using Wheelchair' are working together to escape the building; They move in unison; They display the same urgency, motion, and appear to be travelling at the same speed. *Registered designs reproduced under license ©®.

 1 2164 GL 2 2164 GL 3 2164 GL 4 2164 GL	 1 2165 GL 2 2165 GL 3 2165 GL 4 2165 GL	 1 2162 GL 2 2162 GL 3 2162 GL 4 2162 GL	 1 2163 GL 2 2163 GL 3 2163 GL 4 2163 GL
--	---	---	---

Hospitals and Health Services

Some health services still display fire exit signs with flames, however, NHS organisations are now expected to comply with the standard ISO 7010 signage, as found on pages 15 - 17.

 1 2092 GLM 2 2092 GL 3 2092 GLM 4 2092 GL	 1 2108 GLM 2 2108 GL 3 2108 GL	 1 2107 GLM 2 2107 GL 3 2107 GL	 1 2081 JV 2 2081 JV 3 2081 V 4 2081 JV	 1 2109 C 2 2109 C 3 2109 F
 1 2084 GLM 2 2084 GL 3 2084 GLM 4 2084 GL	 1 2121 GLM 2 2121 GL 3 2121 GL	 1 2090 GLM 2 2090 GL 3 2090 GLM 4 2090 GL	 1 2082 JV 2 2082 JV 3 2082 V 4 2082 JV	 1 2110 C 2 2110 C 3 2110 F
 1 2120 GLM 2 2120 GL 3 2120 GL	 1 2083 GLM 2 2083 GL 3 2083 GLM 4 2083 GL	 1 2088 GLM 2 2088 GL 3 2088 GLM 4 2088 GL	 1 2086 GLM 2 2086 GL 3 2086 GLM 4 2086 GL	

Intermediate Markers

ISO 16069:2017 describes the principles governing the design and marking for Safety Way Guidance Systems. In addition to the requirement for installing exit signs at 1.7m - 2.2 metres from the ground, this standard recommends that additional intermediate and low location markings may also be required. Position at a maximum height of 400mm from the floor for low level marking. Subject to a full risk assessment, additional escape guidance should be provided through the use of both continuous guidance lines and safety signs to ensure there is an uninterrupted safety sign system to aid an efficient and safe evacuation from a building. Fire fighting equipment, hazards along an escape route, boundaries, stairs and ramps should also be identified.



Door Plates

These door plates are manufactured from Photoluminescent Rigid Plastic and are complete with a self adhesive backing.

Plates should be installed to reinforce the exit message. They should not be installed instead of an exit/fire exit sign above the door.

75 x 300mm

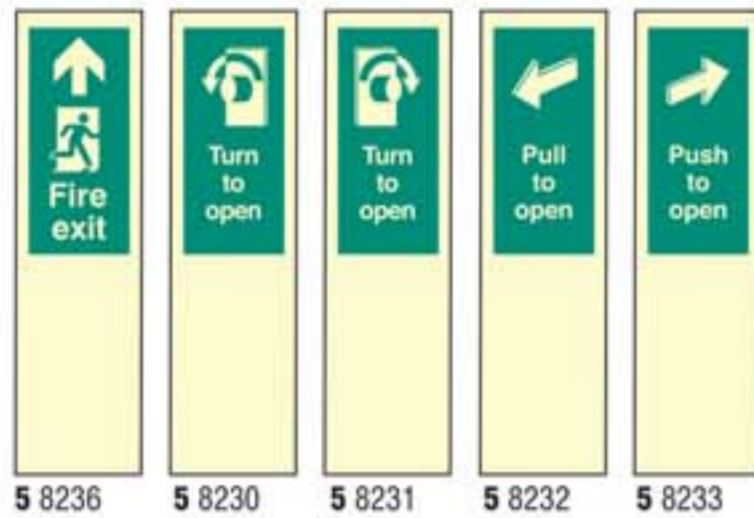

Projecting Signs

Visible from a number of angles, these projecting signs help in the quick identification of suitable exit or fire exit routes. Includes drilling guide for simple installation. Designed to conceal fixings for a neat finish.



Photoluminescent Safety Tapes

10 Metre Roll - Self Adhesive Vinyl - Perfect for highlighting door frames and / or the location of fire fighting equipment.

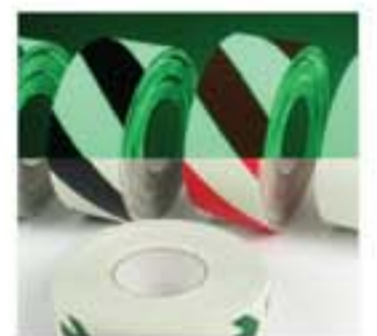

Ultra Bright

Exceeds Class C Photoluminescent PSPA rating
Afterglow testing in accordance with DIN 67510-P11
Compliant with ISO 16069:2017 (SWGS)
Non-toxic or radioactive pigments (REACH & RoHS)

Marking Strips

Perfect as a low level repeater message to compliment your fire escape strategy.



Floor Markers

Photoluminescent way finding floor markers are an effective method of marking escape routes. These floor markers have an anti-slip surface, strong adhesive backing and come in packs of 20.

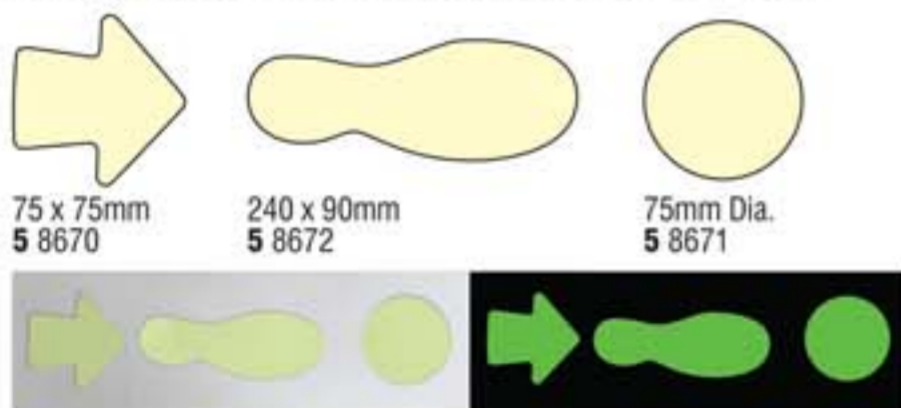

Class D Deluxe Floor Markers

Aluminium back provides extra strength and durability in high traffic areas. Anti-slip surface. Photoluminescent Class D aluminium with adhesive backing.

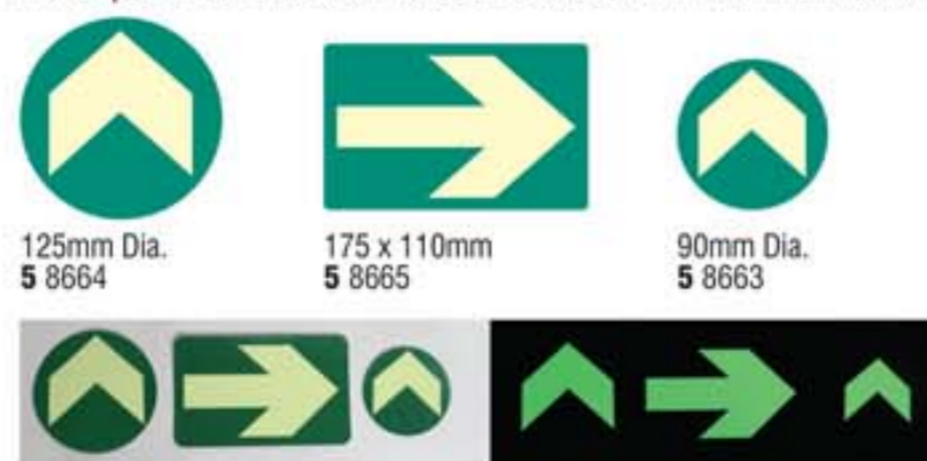

Emergency Lighting Fascias

Replace the front of an emergency light with an ISO 7010 compliant graphic



Self Adhesive Overlay

This overlay enables you to tear-off symbols and text and place over emergency lighting. Choose clear version for fluorescent bulbs or white vinyl for LED light units.



Material Codes

- 1 Rigid Plastic
- 2 Self Adhesive Vinyl
- 3 Photolum Rigid Plastic
- 4 Photolum Self Adhesive
- 5 Miscellaneous

Landscape Sizes

- C 150 x 150mm
- F 200 x 200mm
- G 300 x 100mm
- H 300 x 250mm
- J 400 x 200mm
- L 450 x 150mm
- M 600 x 200mm
- V 300 x 150mm
- X 200 x 100mm

Portrait Sizes

- E 150 x 200mm
- H 250 x 300mm

Assembly Point Signs



It must not be assumed that, once outside a building, people will know how to get to an assembly area. Signs directing to the assembly area may be required.

						
1 2059 HQ 2 2059 HQ 6 2059 HQ 7 2059 Q	1 2054 HQ 2 2054 HQ 6 2054 HQ 8 2054 HQ	1 2055 HQ 2 2055 HQ 6 2055 HQ 8 2055 HQ	Rigid Plastic 600 x 400 mm 5 2111	Rigid Plastic 250 x 300 mm 5 2115 Rigid Plastic 450 x 600 mm 5 2116		E.g. Assembly point

For a full range of posts, clips and fixings see pages 136 137.

Assembly Point Signs for Posts

All signs in this section include channelling for pole mounting - Pole not included

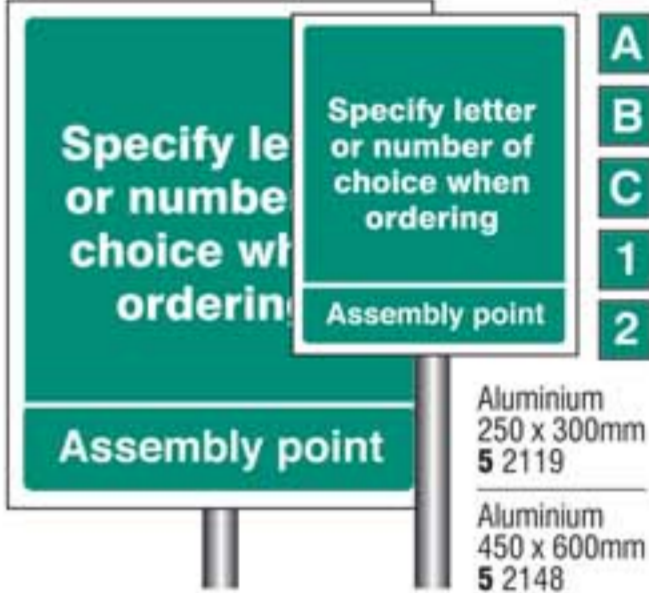
			
	Aluminium 250 x 300mm 5 2112 Aluminium 450 x 600mm 5 2113	Aluminium 600 x 400mm 5 2114	Aluminium 250 x 300mm 5 2119 Aluminium 450 x 600mm 5 2148



Directional Assembly Point Signs

			
1 2141 LH 2 2141 LH 6 2141 H 8 2141 H	1 2142 LH 2 2142 LH 6 2142 H 8 2142 H	1 2143 LH 2 2143 LH 6 2143 H 8 2143 H	Rigid Plastic 150 x 50mm 5 2158 Rigid Photoluminescent 150 x 50mm 5 8661 Rigid Plastic 450 x 150mm 5 2159 Rigid Photoluminescent 450 x 150mm 5 8662

Directional Assembly Point Verge Signs

A quick and easy solution for indicating the location of external assembly points. Can be simply sunk into the grass verge using the pole spike for temporary use or can be set into concrete for extra stability and permanent fixtures. When ordering customised verge signs please state the message, logo or number you wish to display.

2mm Aluminium - 450 x 150mm - 800mm pole

	<p>We have a large range of verge signs suitable for many purposes.</p> <p>You can find the full range on page 104.</p> <p>Need a different size of verge sign? Don't worry we can manufacture the verge signs to suit your requirements.</p> <p>Contact us now for a quote.</p>
	
	
5 6540	
5 6541	
5 6592	

Mobile Assembly Point Sign

Designed for a fire warden to use during a fire evacuation. Ideal for built up areas where there is no fixed assembly point such as city centres. Collapsible pole enables easy storage until required.

Aluminium
450 x 600mm
2.4m Pole
Collapsible
5 2123

Evacuation Procedures: Choosing an Assembly Point.

Fire assembly points should be far enough away from the building to avoid interference with the fire brigade and danger from falling debris caused by the fire. Providing clear and visible signage will help ensure all evacuees know where to gather in the event of a fire or fire drill. They must be easily accessible and have an unobstructed pathway leading to them. Larger sites may require multiple assembly points that can be identified with allocated numbers/letters.

Designated Smoking Area Signs

Whilst we actively endorse and, wherever possible, adhere to the relevant Standards, we feel in this specific instance signs permitting smoking should under no circumstance be deemed as "safe" (Under BS EN ISO 7010 and BS 5499 signs relating to Designated Smoking Areas are deemed as "Safe Condition" signs. Safe Condition signs would normally use white text on a green background, alongside a tick or appropriate symbol). In acknowledgement of the damaging effects of smoking, please note our range of signs utilise the colour black to clearly differentiate these signs from Safe Condition signs.



1 3256 G
2 3256 G



1 3257 G
2 3257 G



1 3253 G
2 3253 G



1 3089 G
2 3089 G



1 3251 G
2 3251 G



1 3084 G
2 3084 G



1 3248 EK



1 3246 HK
2 3246 H



1 3247 EHK
2 3247 EHK
8 3247 K



1 3249 K



1 3250 H

E-Cigarettes / Vaping Signs



2 3059 GA



1 3259 G
2 3259 G



1 3085 G
2 3085 G



1 3086 G
2 3086 G

Shelter

The shelter provides users with protection from the elements, whether you wish to use it as a company smoking shelter, shuttle bus point or even as a fire assembly point. It's durable and sturdy and will keep users safe from the wind and rain.

Made from high quality components, in a powder coated finish for lasting protection from rust, water, impact and it is also fire resistant. Domed roof prevents water pooling. Includes a cigarette bin with mounting plate. Supplied flat packed with full assembly instructions and drawings.

*Additional carriage charges may apply.

Fire resistant powder coating
2 x 1 metre
5 3034



Bespoke Verge Sign *State text required when ordering

Sink into the grass using the pole spike for temporary use or set into concrete for permanent fixtures.



2mm Aluminium
800mm Pole
450 x 150mm
5 6543

Standing Cigarette Bin

Keep your designated smoking area tidy and free from discarded cigarettes with this floor standing bin.

Manufactured to be rust, chip and dent resistant this cigarette bin is ideal for outdoor locations.

The design is oxygen restricting, helping reduce ignition of waste.

Stainless Steel
800 x 200 x 200mm
5 3083



Wall Mountable Cigarette Bin

Keeps designated smoking areas tidy and free from discarded cigarettes.

Exterior quality / weatherproof with an attractive satin stainless steel finish.

Simple convenient solution for cigarette ends features an internal tray for easy emptying.

Fixings and keys (x2) for locking the bin are included.

Stainless Steel
260 x 320 x 80mm
5 3036



Cigarette Bin Signs

Keep your designated smoking area tidy by highlighting cigarette bins with these smoking area safety signs.



1 3258 D
2 3258 D



1 3081 K
2 3081 K
8 3081 K

Material Codes

1 Rigid Plastic
2 Self Adhesive Vinyl
5 Miscellaneous
6 Aluminium
7 PET
8 Quick Fix

Landscape Sizes

E 200 x 150mm
G 300 x 100mm
H 300 x 250mm
K 400 x 300mm
L 450 x 150mm

Portrait Sizes

A 75 x 100mm
D 100 x 150mm
H 250 x 300mm
K 300 x 400mm
Q 450 x 600mm

No Smoking Regulations

The Smoke-free (Signs) Regulations 2012 state that at least one legible no smoking sign is displayed in smoke free premises.

England and Northern Ireland: You must display signs at each public entrance to any work or public place. Signs should also be displayed in public / business vehicles.

Wales: Any work or public area must display the 'Law' sign at each entrance. General, dual language 'No smoking' signs should also be on display in public and business vehicles.

Scotland: Signs should be displayed at each public entrance to any work or public place. Signs should also be displayed in public / business vehicles.

England and Northern Ireland

		Rigid Plastic A5 (148 x 210mm) Single: 5 3043 Pack of 5: 5 3060	Self Adhesive Vinyl A5 (148 x 210mm) Single: 5 3045 Pack of 5: 5 3061
		Rigid Plastic A4 (210 x 297mm) 5 3042	Self Adhesive Vinyl A4 (210 x 297mm) 5 3046
		Aluminium A5 (148 x 210mm) 5 3062	Face Adhesive Vinyl A5 (148 x 210mm) 5 3020
		Brass A5 (148 x 210mm) 5 3078	

Scotland

		Front 	Back
Rigid Plastic A4 (210 x 297mm) 5 3031	Rigid Plastic A4 (210 x 297mm) 5 3033	Face-adhesive vinyl 75 x 100mm 5 3032	

A face-adhesive vinyl sign allows application to the inside of a glass window / door. It will then show the appropriate message on both sides of the glass.

Wales

1 3025 EH 2 3025 E	Rigid Plastic 160 x 230mm 5 3039

Polish

1 3302 EH	1 3301 EH 2 3301 E

Labels

Roll of 100 Adhesive Vinyl 50mm (Square) 5 9706	Roll of 100 Adhesive Vinyl 75mm Circles 5 9763	Sheet of 6 Adhesive Vinyl 75mm Circles 5 3040	Frosted Vinyl 200mm Dia 5 3041

No Smoking Signs

1 3017 BFN 2 3017 BF 8 3017 BE	1 3003 GMEKP 2 3003 GMEKP 7 3003 GM 8 3003 GE	1 3024 G 2 3024 G	1 3236 G 2 3236 G	1 5619 G 2 5619 G
Anodised Aluminium 140 x 140mm 5 9049	Braille 300 x 150mm 5 6168	Self Adhesive A4 (210 x 297mm) 5 8379	Floor Graphic 400 x 600mm 5 8741	

Table Cards

These double sided table cards are ideal for outdoor seating, picnic benches and other dining areas with restricted smoking areas.

	Rigid Plastic 150 x 50mm Pack of 5 5 8401
	Rigid Plastic 150 x 50mm Pack of 5 5 8402

1 3668 EK 2 3668 EK	1 3080 E 2 3080 E	1 5462 EK 2 5462 EK	1 3006 GMEK 2 3006 GMEK
			1 3005 GME 2 3005 GE

Self Standing Sign

Made from a waterproof, light but strong material ideal for temporary signs.

Fluted Polypropylene 300 x 600mm 5 8510	Fluted Polypropylene 300 x 600mm 5 8526

1 3262 EK 2 3262 EK	1 5468 EK	1 3013 EK 2 3013 EK	1 3012 EK 2 3012 EK

Vehicle Labels

Drivers are banned from smoking in their cars if they have passengers under the age of 18 years in the UK.

2 3008 GA	2 3059 GA	2 3669 S

Restricted Access for Persons



1 3202 **GMEKP** Floor Graphic
2 3202 **GMEKP** 400 x 600mm
8 3202 **GEK** 5 8740



1 3215 **GEK** PVC Banner
2 3215 **GEK** 1270 x 610mm
5 3215



1 3213 **GEKP**
2 3213 **GEK**
7 3213 **GM**
8 3213 **GE**
Rigid Plastic
A4 (210 x 297mm)
5 8380
Self Adhesive Vinyl
A4 (210 x 297mm)
5 8381

Self Standing Signs

Fluted Polypropylene 300 x 600mm
5 8525
*Up to 10 words

Fluted Polypropylene 300 x 600mm
5 8505
Full range on page 34



1 3201 **GMEKP**
2 3201 **GMEKP**
7 3201 **GMP**



1 3205 **GMEKP**
2 3205 **GMEK**
8 3205 **GE**



1 3214 **F**
2 3214 **F**



1 3210 **FN**
2 3210 **F**



1 3207 **GMEKP**
2 3207 **GEK**



1 3208 **GMP**
2 3208 **GM**



1 3203 **GMEKP**
2 3203 **GME**



1 3206 **GM**
2 3206 **GM**



1 3204 **GMK**
2 3204 **GM**



1 3209 **GMK**
2 3209 **GE**



1 3242 **GEK**
2 3242 **GEK**



1 6405 **MP**
2 6405 **P**



1 3662 **G**
2 3662 **G**



1 3664 **G**
2 3664 **G**



1 3651 **G**
2 3651 **G**



1 3650 **G**
2 3650 **G**

English & Polish



1 6443 **P**



1 3263 **EK**
2 3263 **EK**



1 3212 **EK**
2 3212 **EK**
8 3212 **EK**



1 3243 **EH**
2 3243 **EH**



1 6433 **G** PVC Banner
1270 x 610mm
5 5092

Floor Graphics 400 x 600mm
Subsurface printed with anti-slip polycarbonate overlay

5 8819

5 8822

5 8739

Animal Prohibition Signs



1 3602 **FN**
2 3602 **F**



1 5496 **GE**
2 5496 **GE**



1 3603 **GMEK**
2 3603 **GEK**



1 5497 **GE**
2 5497 **GE**



1 3636 **GM**
2 3636 **G**



1 1770 **EK**
2 1770 **EK**



1 1771 **EK**
2 1771 **EK**



1 1774 **EK**
2 1774 **EK**



1 1772 **EK**
2 1772 **EK**



1 3674 **EK**
2 3674 **EK**



1 5467 **EK**

Verge Sign
Sink into the grass or set in concrete for temporary/permanent fixtures.

2mm Aluminium
800mm Pole
450 x 150mm
5 6694

Railway Prohibition



1 3261 **G**
7 3261 **G**



1 3260 **K**
2 3260 **K**

Intoxicated Persons



1 7113 **KQ**
2 7113 **KQ**



1 7114 **GE**
2 7114 **GE**



1 7115 **GE**
2 7115 **GE**



1 7121 **KQ**
2 7121 **KQ**



1 3264 **EK**
2 3264 **EK**

Material Codes

1 Rigid Plastic 5 Miscellaneous 8 Quick Fix
2 Self Adhesive Vinyl 7 PET

Landscape Sizes

B 80 x 80mm F 200 x 200mm K 400 x 300mm N 400 x 400mm Q 600 x 450mm
E 200 x 150mm G 300 x 100mm M 600 x 200mm S 75 x 200mm

Portrait Sizes

A 75 x 100mm H 250 x 300mm P 400 x 600mm
E 150 x 200mm K 300 x 400mm Q 450 x 600mm

Vehicle Prohibition Signs



1 3407 **GMPK** Floor Graphic
2 3407 **GK** 400 x 600mm
7 3407 **P** 5 8737
8 3407 **K**



1 3216 **GMP**



1 3217 **GMP**



1 6590 **GM**



1 5474 **M**



1 3648 **GM**
2 3648 **GM**



1 3606 **GM**



1 3218 **GMEKP** Rigid Plastic
2 3218 **GME** A4 (210 x 297mm)
7 3218 **GM** 5 8368
Self Adhesive Vinyl
A4 (210 x 297mm)
5 8369

Reverse Mirror Sign

This sign is designed to be read in a vehicle mirror. Perfect for busy traffic areas, warehouses and loading bays.



1 3231 **P**



1 3234 **Q**



1 3211 **Q**
2 3211 **Q**



1 3221 **Q** PVC Banner
7 3221 **Q** 1270 x 610mm
5 3221



1 5473 **Q**

Verge Signs

450 x 150mm - 2mm Aluminium sign supplied on a 800mm pole



5 7593



5 6590



5 6695



1 7598 **FN**



2 3669 **S**



2 3670 **A**



2 3240 **A**



2 3239 **A**

Machinery Prohibition Signs



1 3401 **GM**
2 3401 **G**



1 3404 **G**
2 3404 **G**



1 3406 **G**
2 3406 **G**



1 3402 **G**
2 3402 **G**



1 3655 **G**
2 3655 **G**



1 3656 **G**
2 3656 **G**



1 3644 **G**
2 3644 **G**



1 3659 **G**
2 3659 **G**



1 3403 **GM**
2 3403 **GM**
8 3403 **G**



1 3653 **G**
2 3653 **G**



1 3609 **G**
2 3609 **G**



1 3665 **GM**
2 3665 **GM**



1 3410 **GM**



1 3677 **GM**



1 3633 **GM**



1 6243 **Q**
2 6243 **A**



1 6244 **Q**
2 6244 **A**



Self Adhesive Vinyl
35 x 25mm
5 3432



Self Adhesive Vinyl
35 x 25mm
5 3431



1 3405 **E**
2 3405 **E**



Adapt-a-Sign Frame

Print out your own message on a standard A4 piece of paper and insert into the Adapt-a-Sign frame.

3mm PVC with Clear PVC Cover
310 x 210mm - 10mm coloured border - Holds standard A4 sheet



Labels

Ready to Peel. Self Adhesive Vinyl



Roll of 100
50 x 50mm
5 9710



Sheet of 10
40 x 18mm
5 3436





















Sheet of 10
40 x 18mm
5 3437



Sheet of 10
40 x 18mm
5 3438

General Prohibition Signs

 <p>Do not use mobile phones</p> <p>1 3607 G M E K 2 3607 G M E K 8 3607 G</p>	 <p>No ball games</p> <p>1 3611 G M 2 3611 G M 7 3611 G M P</p>	 <p>Do not climb on racking</p> <p>1 3219 G M 2 3219 G M 8 3219 G</p>	 <p>Not drinking water</p> <p>1 3605 G M A 2 3605 G M A 8 3605 A</p>				
 <p>No wireless, electronic or recording devices allowed beyond this point</p> <p>1 3671 G M 2 3671 G M</p>	 <p>Do not jump from the loading dock</p> <p>1 3646 G M 2 3646 G M</p>	 <p>Do not attempt to lift heavy loads single handed</p> <p>1 3635 G 2 3635 G</p>	 <p>The consumption of food or drink is forbidden in this area</p> <p>1 3631 G M 2 3631 G M</p>				
 <p>No cameras or video recording equipment</p> <p>1 3637 G 2 3637 G</p>	 <p>Do not cover</p> <p>1 3640 G 2 3640 G</p>	 <p>No tipping or dumping</p> <p>1 3601 G M</p>	 <p>No radios</p> <p>1 3237 G M</p>				
 <p>No electronic devices allowed beyond this point</p> <p>1 5475 K 2 5475 K</p>	 <p>No fly tipping Fly tipping is an offence under the Environmental Protection Act (1990). Offenders may face up to a £50,000 fine and/or a prison sentence.</p> <p>1 1743 K Q 6 1743 Q</p>	 <p>Cameras and camera phones prohibited</p> <p>1 3643 E K 2 3643 E</p>	 <p>No eating or drinking in this area</p> <p>1 3232 E K 2 3232 E K</p>	 <p>No food or drink beyond this point</p> <p>1 3675 E K 2 3675 E K</p>	 <p>No pacemakers</p> <p>1 3235 G 2 3235 G</p>		
 <p>This chair is not in use Do not sit here</p> <p>1 8475 F 2 8475 F</p>	 <p>This desk is not in use Do not sit here</p> <p>1 8493 F 2 8493 F</p>	 <p>Do not flush sanitary products down the toilet</p> <p>1 5229 A 2 5229 A</p>	 <p>Please do not put tea bags, nappies or other sanitary disposables down the toilet. Use the bin provided.</p> <p>1 3629 A 2 3629 A</p>	 <p>1 3613 F N 2 3613 F 8 3613 F</p>	 <p>1 3604 F 2 3604 F 8 3604 F</p>	 <p>No Drones Use of drones and UAVs over this site is strictly prohibited Anyone found operating a drone over this location will be reported for prosecution and subject to civil legal action</p> <p>1 3649 K Q</p>	 <p>THIS IS A NO DRONE ZONE Unauthorised use of drones in this area is strictly prohibited OFFENDERS ARE LIABLE FOR PROSECUTION If you see someone preparing to fly, or flying a drone report it immediately to...</p> <p>1 3676 K Q 2 3676 K Q</p>

Water's Edge

These water edge prohibition signs have been designed to the specifications of ISO 20712-3: 2014 Water Safety Signs which ensures maximum comprehension.

 <p>No swimming</p> <p>1 3626 E K</p>	 <p>No diving</p> <p>1 3614 E K</p>	 <p>No fishing</p> <p>1 3615 E K</p>	 <p>No outdoor footwear</p> <p>1 3618 E</p>	 <p>No running</p> <p>1 3621 E K</p>
--	--	---	--	--

Labels

Ready to Peel. Self Adhesive Vinyl



Roll of 100
50 x 50mm
5 9709



Sheet of 6
65mm Dia.
5 6099

Bespoke Labels



your company
01234 567890

Don't see the message you require? We can supply labels on sheets or on a roll. Contact us with your requirements to receive a quote.

Safety Tags

These double sided safety tags are manufactured from Matt PVC - Pack of 10 - 80 x 150mm - Supplied with 150mm nylon cable ties

 <p>Do not switch off</p> <p>5 3420</p>	 <p>Do not operate</p> <p>5 3422</p>	 <p>Do not move</p> <p>5 3435</p>	 <p>Do not open</p> <p>5 3426</p>	 <p>Do not close</p> <p>5 3427</p>	 <p>Do not use</p> <p>5 3434</p>	 <p>Do not open valve</p> <p>5 3429</p>	 <p>Do not close valve</p> <p>5 3425</p>	 <p>Do not touch</p> <p>5 3424</p>
 <p>Do not start</p> <p>5 3428</p>	 <p>Do not switch on</p> <p>5 3421</p>	 <p>Danger Equipment locked out Do not operate</p> <p>5 5071</p>	 <p>Do not start this equipment when locked out</p> <p>5 5072</p>	 <p>Do not tamper with lock out devices</p> <p>5 5073</p>	 <p>Do not remove this scaffold tie This tie has not been tested</p> <p>5 3445</p>	 <p>Do not remove this scaffold tie</p> <p>5 3444</p>	 <p>Warning Do not use</p> <p>5 3419</p>	 <p>Maintenance in progress do not switch on</p> <p>5 3423</p>



Material Codes

- 1 Rigid Plastic
- 2 Self Adhesive Vinyl
- 5 Miscellaneous
- 6 Aluminium
- 7 PET
- 8 Quick Fix

Landscape Sizes

- A 100 x 75mm
- F 200 x 200mm
- G 300 x 100mm
- K 400 x 300mm
- M 600 x 200mm
- N 400 x 400mm
- O 600 x 450mm
- S 200 x 75mm

Portrait Sizes

- A 75 x 100mm
- E 150 x 200mm
- K 300 x 400mm
- P 400 x 600mm
- Q 450 x 600mm

Warning Signs

Harmful Substances

Displayed to advise and forewarn of potential dangers. These signs should include a yellow triangle with black border containing a warning symbol conforming to ISO 7010.

The signs' supplementary text should always include one of three words:- **Danger** - High level risk that could result in death or serious injury. This keyword should be limited to the most extreme hazard cases. **Warning** - Medium level risk that could result in minor or moderate injury. **Caution** - Low level risk that could lead to minor injury.

 1 4425 GM 2 4425 GM	 1 4413 GM 2 4413 GM	 1 4408 GM EK 2 4408 GM EK	 1 4446 GM 2 4446 GM	 1 4459 GM 2 4459 G	Rolls of Labels Self Adhesive Vinyl labels ready to peel and apply. Roll of 100 50 x 50mm 5 9721 Roll of 100 50 x 50mm 5 9725
		 1 4455 G 2 4455 G	 1 4247 G 2 4247 G		
 1 4418 F 2 4418 F	 1 4416 F 2 4416 F	 1 4519 GM 2 4519 GM	 1 4451 GM 2 4451 GM		

Flammable Substances

 1 4490 GM 2 4490 GM	 1 4420 GM 2 4420 GM	 1 4421 GM 2 4421 GM	 1 4453 GM 2 4453 G	 1 4424 GM 2 4424 G	 1 4414 F 2 4414 F	 1 4427 GM P 2 4427 GM P
					 1 4417 F 2 4417 F	 1 4448 GM 2 4448 G

Asphyxiation

Situations that can cause asphyxia include but are not limited to: being in environments where oxygen is not readily accessible: such as in a low oxygen atmosphere or in a vacuum / confined space; environments where sufficiently oxygenated air is present however it cannot be adequately breathed in due to excessive smoke / dust particles.

 1 4325 GM 2 4325 GM	 1 4326 GM 2 4326 GM	 1 4327 GM 2 4327 GM	 1 4443 G 2 4443 G
 1 4412 G 2 4412 G	 1 4410 GM 2 4410 GM	 1 4549 G 2 4549 G	 1 4429 G 2 4429 G

Compressed Gases

 1 4415 F 2 4415 F	 1 6502 GM 2 6502 G	 1 4248 GM EK 2 4248 GM EK	 1 4520 GM 2 4520 GM	 1 4563 GM EK 2 4563 GM EK
--	---	--	--	--

Explosive Materials

 1 4302 G	 1 4480 GM 2 4480 GM	 1 4479 GM P 2 4479 GM	 1 4431 G 2 4431 G	D.S.E.A.R Dangerous Substances and Explosive Atmosphere Regulations Rigid Plastic - 400 x 600mm 5 8128
 1 4479 G 2 4479 G	 1 4481 FN 2 4481 F	 1 4217 F 2 4217 F	 1 4478 F 2 4478 FU	
	 1 4481 FN 2 4481 F	 1 4217 F 2 4217 F	 1 4478 F 2 4478 FU	

Irritant, Caustic & Corrosive Substances

Warning Corrosive 1 4405 G 2 4405 G	Danger Battery acid 1 4407 G 2 4407 G	Danger Hydrochloric acid 1 4404 G 2 4404 G	Warning Caustic 1 4406 G 2 4406 G
Danger Acid 1 4401 GM 2 4401 GM	Warning Chemical waste 1 4484 G 2 4484 G	Warning Chlorine 1 4442 GM 2 4442 G	Warning Chemical irritants 1 4489 E 2 4489 E
Warning Irritant 1 4419 F 2 4419 F	Warning Irritant 1 4454 G 2 4454 G	Caution Bleach and other harmful irritants and substances are stored in this cupboard 1 4400 G 2 4400 G	Warning Corrosive 1 4426 E 2 4426 E

Asbestos

Danger Asbestos 1 4259 GM P 2 4259 GM 8 4259 G	Danger Asbestos hazard 1 4409 GM P 2 4409 GM	CAUTION ASBESTOS HAZARD Non-Adhesive Polythene 75mm x 250mm 5 8607	Rolls of Labels Roll of 100 - Self Adhesive Vinyl - 27 x 50mm
Danger Asbestos removal in progress 1 4449 GM 2 4449 G	Danger This product contains asbestos 1 4260 GM 2 4260 G	Warning Asbestos Double Sided Matt PVC Tags x 10 80 x 150mm Comes with 150mm Cable Ties 5 5059	
			WARNING CONTAINS BLUE ASBESTOS Breathing asbestos dust is dangerous to health Follow safety instructions 5 9832
			WARNING CONTAINS ASBESTOS Breathing asbestos dust is dangerous to health Follow safety instructions 5 9765
			ASBESTOS FREE MATERIAL Breathing asbestos dust is dangerous to health 5 9869

Lower Risk Hazard Warnings

Warning Fire risk 1 4486 GK	Warning Pesticide 1 4457 G 2 4457 G	Caution High noise level 1 5220 GM 2 5220 GM	Warning Wet paint 1 4253 GM 2 4253 G
--	---	--	--

Radioactive, Biohazard & Lasers

Danger Biohazard Protective clothing must be worn 1 4525 G 2 4525 G	Danger Biohazard 1 4536 EK 2 4536 E	Danger Radiation risk 1 4462 EK 2 4462 EK	Warning Laser hazard 1 4014 EK 2 4014 E	Warning Laser beam 1 4016 EK 2 4016 E	Rolls of Labels Self Adhesive Vinyl stickers supplied ready to peel and apply.
Bespoke Warning Signs To create your own warning message see page 148.					
Your warning message here 1 4256 F 2 4256 F	1 4256 F 2 4256 F	2 4537 G	Self Adhesive 25 x 25mm 5 1692		
					Roll of 100 50 x 50mm 5 9719
					Roll of 100 50 x 50mm 5 9724
					Roll of 100 50 x 50mm 5 9726

Temperature

Caution Hot 1 4208 GM 2 4208 G 8 4208 G	Caution Hot surface 1 4285 GM 2 4285 GM	Caution High temperature 1 4482 G 2 4482 G	Caution Low temperature 1 4483 G 2 4483 G
Caution Hot surface Do not touch 1 4237 AE 2 4237 AE 8 4237 AE	Caution Risk of extreme temperatures Stay hydrated and wear sun protection 1 4564 G 2 4564 G	Caution Very hot water 1 4236 GA 2 4236 GAK 8 4236 GA	Caution Hot rail 1 4286 A 2 4286 A
Temperature Warning Labels Sheet of 6 - 65mm Diameter - Self Adhesive Vinyl			
5 6598			
5 6098			

Material Codes

1 Rigid Plastic
2 Self Adhesive Vinyl

5 Miscellaneous
8 Quick Fix

Landscape Sizes

A 100 x 75mm E 200 x 150mm G 300 x 100mm N 400 x 400mm U 100 x 100mm
C 150 x 150mm F 200 x 200mm M 600 x 200mm Q 600 x 450mm

Portrait Sizes

A 75 x 100mm E 150 x 200mm K 300 x 400mm P 400 x 600mm



Industrial Vehicles / Robotics

 <p>Caution Forklift trucks operating</p> <p>1 4215 GMEKP 2 4215 GMEKP 7 4215 GMP 8 4215 GM</p> <p>Floor Graphic 400 x 600mm 5 8734</p>	 <p>This vehicle records images for the purpose of crime prevention and road safety</p> <p>2 1806 E</p>	 <p>Danger Vehicles unloading</p> <p>1 4244 KP</p>	 <p>Warning This vehicle makes wide turns</p> <p>2 1812 E</p>	<p>English & Polish</p>  <p>Caution Forklift trucks operating Uwaga na wózki widłowe</p> <p>1 4298 K 2 4298 K</p>	 <p>Warning Forklift trucks operating</p> <p>Rigid Plastic A4 (210 x 297mm) 5 8374</p> <p>Self Adhesive A4 (210 x 297mm) 5 8375</p>
 <p>Danger Stop. Look. Listen. Beware of trucks</p> <p>1 4205 GMP 2 4205 GM</p> <p>Floor Graphic 400 x 600mm 5 8735</p>	 <p>Danger Stop. Look. Listen. Beware of vehicles</p> <p>1 4206 GMP 2 4206 GM 8 4206 GM</p>	 <p>Warning Battery charging in progress</p> <p>1 4211 GMEK 2 4211 GMEK</p> <p>Projecting Sign Face: 150 x 200mm 5 4301</p>	 <p>1 4222 FN 2 4222 F</p>	 <p>Caution Forklift Trucks</p> <p>Braille 300 x 150mm 5 6319</p>	
 <p>Caution Forklift trucks have priority of way in this area</p> <p>1 4243 GM 2 4243 G</p>	 <p>Warning Beware of moving vehicles</p> <p>1 6459 GM 2 6459 GM</p>	 <p>Warning Forklift charging area</p> <p>1 4332 MP 2 4332 M</p>	 <p>Warning Moving traffic beyond this point</p> <p>1 4491 GM 2 4491 GM</p>		
 <p>Warning When operating keep feet clear of tailgate edges</p> <p>2 4254 G</p>	 <p>Warning Moving vehicles</p> <p>1 6504 GM 2 6504 G</p>	 <p>Danger Refuelling area</p> <p>1 6692 GK 2 6692 GK</p>	<p>Warning Forklifts operating</p>  <p>Pedestrians must keep to the marked walkways</p> <p>1 4333 M 2 4333 M</p>		

Robotics / Machinery

 <p>Caution This machinery is automatic and may start without warning</p> <p>1 4228 GM 2 4228 GM 8 4228 G</p>	 <p>Warning Remotely operated machinery</p> <p>1 4316 GM 2 4316 GM</p>	 <p>Warning Moving remote operator controlled machines in this area</p> <p>1 4317 GM 2 4317 GM</p>	 <p>Warning Remotely operated machinery may move without warning</p> <p>1 4318 GM 2 4318 GM</p>	
 <p>Caution Pinch point</p> <p>1 4283 E 2 4283 E</p>	 <p>Caution Sharp blades</p> <p>1 4284 E 2 4284 E</p>	 <p>Caution Beware of machine rollers</p> <p>1 4263 G 2 4263 G</p>	 <p>Caution Moving machinery</p> <p>1 4226 G 2 4226 G</p>	 <p>Warning Misuse of compressed air is highly dangerous and may cause permanent injury or death</p> <p>1 4441 GM 2 4441 G</p>
 <p>Warning Danger of crushing</p> <p>1 3666 GM 2 3666 GM</p>	 <p>Caution Never operate this machine without the proper guards in position</p> <p>1 4264 G 2 4264 G</p>	 <p>Warning It is dangerous and illegal to operate machines without the proper guards in position</p> <p>2 4262 G</p>		

Site Security

 <p>Warning Anti climb paint</p> <p>1 1714 GM 2 1714 GM 7 1714 GM 8 1714 G</p>	 <p>Warning Razor wire</p> <p>1 1715 GM 2 1715 G 7 1715 GM</p>	 <p>Warning Barbed wire</p> <p>1 1720 GM 2 1720 G 7 1720 GM</p>	 <p>Warning Electric fence</p> <p>1 4023 GM 2 4023 G</p>			
 <p>Warning Shoplifters will be prosecuted</p> <p>Face Adhesive 75 x 100mm 5 1729</p>	 <p>Warning This property is patrolled by security guards</p> <p>Face Adhesive 75 x 100mm 5 1730</p>	 <p>Warning These premises are alarmed</p> <p>Face Adhesive 75 x 100mm 5 1702</p>	 <p>Warning This vehicle is fitted with a tracker</p> <p>2 1826 E</p>	 <p>Caution Security alarm will sound if door is opened</p> <p>1 1738 G 2 1738 G</p>		
 <p>Warning CCTV in operation</p> <p>Rigid Plastic A4 (210 x 297mm) 5 8366</p> <p>Self Adhesive A4 (210 x 297mm) 5 8367</p>	 <p>Warning This is a security patrolled area</p> <p>1 1727 HK</p>	 <p>Warning Trespassers will be prosecuted</p> <p>1 1731 HK</p>	 <p>Warning All vehicles entering or leaving these premises are liable to be searched</p> <p>1 7530 Q</p>	 <p>Warning This is a restricted area</p> <p>1 1728 HK 2 1728 H</p>	<p>Warning Guard dogs on patrol</p>  <p>Keep out</p> <p>1 6215 GMP</p>	 <p>CCTV Signs For our full range of CCTV signs see page 81.</p> <p>1 4220 F 2 4220 F</p>

Construction Site Warnings



1 4201 **GM** **P**
2 4201 **GM**
Rigid Plastic
A4 (210 x 297mm)
5 8376
Self Adhesive
A4 (210 x 297mm)
5 8377



1 4334 **GM** **P**
2 4334 **GM**
Rigid Plastic
A4 (210 x 297mm)
5 4328
Self Adhesive
A4 (210 x 297mm)
5 4329



1 4494 **GM**
2 4494 **GM**
8 4494 **G**



1 4261 **GM** **E** **K** **P**
2 4261 **GM** **E** **K** **P**
8 4261 **GE**



1 4202 **GM** **P**
2 4202 **GM**



1 4335 **GM** **P**
2 4335 **GM**



1 4238 **GM**
2 4238 **G**



1 4204 **GM** **O** **P**
2 4204 **GM**



1 4203 **GM** **P**



1 4336 **GM** **P**



1 6403 **M** **P** PVC Banner
1270 x 610mm
2 6403 **M** 5 5088



1 6456 **GM** PVC Banner
1270 x 610mm
5 6456



1 4245 **GM**



1 4337 **GM**



1 4240 **GM**
2 4240 **GM**
8 4240 **G**



1 4497 **GM**
2 4497 **GM**
8 4497 **G**



1 6418 **GM** **P**
2 6418 **G**



1 6455 **GM**
2 6455 **G**



1 4250 **GM**



1 4212 **GM** **E** **K**
2 4212 **G**



1 6503 **GM**
2 6503 **GM**



1 4230 **G**
2 4230 **G**



1 4493 **GM**
2 4493 **GM**



1 5932 **G** **K**
2 5932 **G** **K**



1 6454 **GM**



1 6460 **GM**



1 6442 **P**



Rigid Plastic
A4 (210 x 297mm)
5 8360
Self Adhesive
A4 (210 x 297mm)
5 8361



1 4219 **FN**
2 4219 **F**



1 4411 **GM**
2 4411 **GM**



1 6417 **M** **O**



1 6462 **G**



1 6680 **G**



1 6681 **G**



1 7612 **G**



1 6450 **G**



1 6434 **G**



1 6451 **G**



1 4338 **G**

Material Codes

1 Rigid Plastic 5 Miscellaneous 8 Quick Fix
2 Self Adhesive Vinyl 7 PET

Landscape Sizes

E 200 x 150mm **G** 300 x 100mm **N** 400 x 400mm **O** 600 x 450mm
F 200 x 200mm **M** 600 x 200mm **P** 600 x 400mm

Portrait Sizes

D 150 x 100mm **H** 250 x 300mm **P** 400 x 600mm
E 200 x 150mm **K** 300 x 400mm **O** 450 x 600mm

Warning Signs

Electrical Labels

A range of small electrical labels which can be used to highlight voltage supplies. Supplied on self adhesive vinyl and 40 x 50mm in size.

Roll of 100: 5 9793 Sheet of 25: 5 4054	Roll of 100: 5 9769 Sheet of 25: 5 4050	Roll of 100: 5 9789 Sheet of 25: 5 4053	Roll of 100: 5 9768 Sheet of 25: 5 4049	Roll of 100: 5 9788 Sheet of 25: 5 4052	Roll of 100: 5 9767 Sheet of 25: 5 4048	Roll of 100: 5 9814 Sheet of 25: 5 4060	Roll of 100: 5 9817 Sheet of 25: 5 4062
Roll of 100: 5 9787 Sheet of 25: 5 4051	Roll of 100: 5 9795 Sheet of 25: 5 4056	Roll of 100: 5 9797 Sheet of 25: 5 4058	Roll of 100: 5 9818 Sheet of 25: 5 4063	Roll of 100: 5 9796 Sheet of 25: 5 4057	Roll of 100: 5 9794 Sheet of 25: 5 4055	Roll of 100: 5 9798 Sheet of 25: 5 4059	Roll of 100: 5 9816 Sheet of 25: 5 4061

BS 7671 Warning Labels

Designed to comply with IET wiring regulations BS 7671:2018

75 x 50mm Sheet of 10: 5 4034	75 x 50mm Roll of 100: 5 9819	100 x 75mm Roll of 100: 5 9584 Sheet of 9: 5 4064	100 x 75mm Roll of 100: 5 9764 Sheet of 9: 5 4065	Roll of 100 12.5 x 12.5mm 5 9833
				Roll of 100 25 x 25mm 5 9834

PAT Testing

Portable Appliance Testing is the name of a process in which electrical appliances are routinely checked for safety. The formal term for the process is in-service inspection and testing of electrical equipment. PAT Test labels should comply with IEE regulations, ensuring all required information is on the label.

	Roll of 250 50 x 25mm 5 4045	Roll of 250 50 x 25mm 5 4028

Permit to Work - Electrical Works

They include risk assessment and sign-off to ensure that only competent employees are working on electrical works.

Permits contain 3 parts (original, plus two carbon copies for management records) with a card backing in the form of an A4 sign.

An integral part of any Health and Safety Management System.

5 8171

Electricity Posters

Provide staff with guidance on the potential hazards of electricity and what actions should be taken to minimise risk with these informative safety posters.

Rigid Plastic
400 x 600mm
5 8134

Synthetic Paper
594 x 420mm
5 8999

Posters and Frames

For our full range of posters and frames see pages 44 - 53.

Electricity Warnings

 1 4002 GE 2 4002 GE	 1 4024 G 2 4024 GE	 1 4001 GMEK 2 4001 GE	 1 4022 GM 2 4022 GM
 1 4003 GMEK 2 4003 GMEK	 1 4004 GE 2 4004 GE	 1 4031 G	 1 4005 GM 2 4005 GE
 1 4017 GM 2 4017 GM	 1 4010 GMEKP 2 4010 GE	 1 4008 GMEKP 2 4008 E	 1 4007 GMEKP 2 4007 G
 1 4018 GMEKP 2 4018 E	 1 4020 GMEKP 2 4020 GE	 1 4021 GMEKP 2 4021 M	 1 4029 GM 2 4029 GM
 2 4068 G	 1 4015 GMEKP	 1 4025 GM	 1 4339 GM
 1 4460 G	 1 4249 G 2 4249 G	 1 4465 G 2 4465 G	 1 4009 GMEKP 2 4009 GMEK 7 4009 GM 8 4009 GM
 1 6219 GMP 2 6219 G	 1 4265 G 2 4265 G	 1 4221 FN 2 4221 F	 1 4218 F 2 4218 F
 1 4012 DEK 2 4012 DEK 8 4012 E Rigid Plastic A4 (210x297mm) 5 8386 Self Adhesive A4 (210x297mm) 5 8387	 1 4013 EKP 2 4013 KP	 1 4011 DE 2 4011 DE	 1 4019 D 2 4019 D

Labels
Self Adhesive Vinyl labels supplied ready to peel and apply.



Roll of 100
50 x 50mm
5 9720



Sheet of 6
Self Adhesive
100 x 100mm
5 4038
50 x 50mm
5 4036

Arc Flash

An arc flash is an explosive release of energy that includes brilliant light, dangerous sound levels and sometimes a blast pressure wave. It is primarily caused by an electrical short circuit or overvoltage between live conductors or live conductor and earth. Where the flash results in a blast, explosive noise and shrapnel can accompany it. Isolating the supply of electricity and using appropriate PPE are popular methods for reducing the risk of an arc flash, as is the use of appropriate signage to highlight the inherent dangers.

 1 4319 GE 2 4319 GE	 1 4320 GM 2 4320 GM	 1 4321 GM 2 4321 GM	
 See page 148 to create a custom sign	 1 4322 GE 2 4322 GE	 1 4324 GE 2 4324 GE	

Material Codes

- 1 Rigid Plastic
- 2 Self Adhesive Vinyl
- 5 Miscellaneous
- 7 PET
- 8 Quick Fix

Landscape Sizes

- F 200 x 200mm
- G 300 x 100mm
- M 600 x 200mm
- N 400 x 400mm
- P 600 x 400mm

Portrait Sizes

- D 150 x 100mm
- E 200 x 150mm
- K 300 x 400mm
- P 400 x 600mm

Warning Signs

Warning Safety Tags



Highlight faulty / dangerous equipment or machinery with these double sided warning safety tags.

Pack of 10
80 x 150mm
Matt PVC
Supplied with 150mm cable ties



Lock Out Tag Out



1 6241 Q
2 6241 A



1 6240 Q
2 6240 A



1 6245 Q
2 6245 A



1 6242 Q
2 6242 A

Labels



Sheet of 6
Self Adhesive Vinyl
105 x 99mm
5 4041



Lock Out Tag Out

Identify and isolate hazards that may cause injury with our full range of Lock Out Tag Out products found on pages 96 - 97.



1 4210 G
2 4210 G

Noise



1 5220 GM
2 5220 GM



1 5223 GM
2 5223 GM
8 5223 G



1 5222 GM
2 5222 GM
8 5222 G



1 6251 GM
2 6251 GM
8 6251 G

Vibration

The Control of Vibration at Work Regulations 2005 seeks to restrict exposure to vibration. Without appropriate control Hand Arm Vibration Syndrome (HAVS) and Vibration White Finger can be a consequence.

Hand Arm Vibration Safety	
Vibration in m/s ²	Maximum Daily Usage Time in Hours (ELV)
Below 5 LOW	8 Hours
5 to 10 MEDIUM	2 Hours
Over 10 HIGH	Assess risk

1 4447 K
2 4447 K

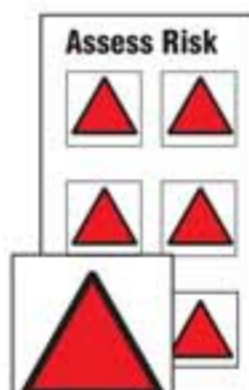

Self Adhesive Vinyl
25 x 25mm
5 5054

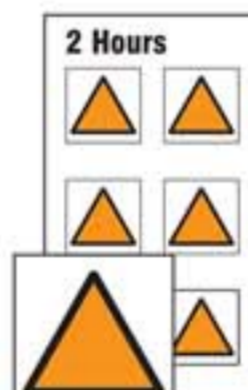

Self Adhesive Vinyl
25 x 25mm
5 5055

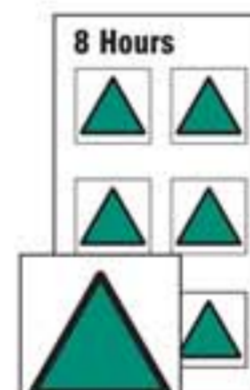

Self Adhesive Vinyl
25 x 25mm
5 5056



Self Adhesive Vinyl
50 x 75mm
5 5051



Self Adhesive Vinyl
50 x 75mm
5 5050

Allergy Warnings

Since December 2014 restaurants and food outlets have been required to display details of possible allergens contained in menu items being served.



2 5631 B



Synthetic Paper 420 x 594mm 5 5641



Bar and Restaurant Signs
For our full range of bar and restaurant signs see page 84.



Catering and Kitchen Signs
For our full range of catering safety signs see page 40.

Glass / Door Highlighting

Provision 14 of The Workplace (Health, Safety and Welfare) Regulations 1992 states that every window or other transparent surface in a wall or door shall, where necessary for reasons of H&S, be appropriately marked or incorporate features to make it apparent. These self adhesive vinyls can be used to highlight glass surfaces.



2 4131 **X**



2 4130 **X**



1 4255 **G**
2 4255 **G**



2 4132 **X**

Double Sided Glass Door Signs

For double sided glass door signs see page 82.





Frosted Crystal Vinyl
1000 x 150mm
5 9151



Frosted Crystal Vinyl
1000 x 150mm
5 9152



Frosted Crystal Vinyl
1000 x 150mm
5 9465

Custom Frosted Vinyl

We can provide frosted vinyl cut to any shape. Contact us for a quote.



Overhead & Access



1 4216 **GMEK**
2 4216 **GMEK**
8 4216 **G**

Rigid Plastic
A5 (148 x 210mm)
5 8312

Self Adhesive Vinyl
A5 (148 x 210mm)
5 8313



1 4498 **P**
2 4498 **P**



1 4246 **GM**
2 4246 **G**

Self Adhesive Vinyl
400 x 35mm
5 4037



1 4496 **M**
2 4496 **M**



1 5634 **GM**
2 5634 **GM**

Confined Spaces

For more confined space safety signs see page 55.



Impact Protection

Warn of protruding corners, vulnerable pipes and protect people from injury. Our full range of impact protection is on page 59.



32mm

Semi-circular 40/32
Polyurethane Foam with
Self Adhesive Backing
5 9225



40mm

Semi-circular 40/40
Polyurethane Foam with
Self Adhesive Backing
5 9221



40mm

Semi-circular 40/40
Polyurethane Foam
5 9231



40mm

Trapeze 40/40/8
Polyurethane Foam
5 9229



20mm 80mm

Trapeze 40/80/8
Polyurethane Foam
5 9230



Shipping Labels

75 x 100mm - Rolls of 250 - Tough non-rip polypropylene



5 8160



5 8194



5 8195



5 8193



5 8196



LQ Labels



2 4557 **FU**

Roll of 100
Self Adhesive Vinyl
100 x 100mm
5 9837



2 4558 **FU**

Roll of 100
Self Adhesive Vinyl
100 x 100mm
5 9838

Lifting Labels

Required by the Manual Handling Operations Regulations 1992 (as amended 2002).

These labels should be installed onto heavy packages and other items to indicate a manual handling risk.



Self Adhesive Vinyl
50 x 50mm - Roll of 100
5 4030

GHS Labels

See page 99 for our range of GHS shipping labels



Water Safety Signs

Designed to the specifications of BS ISO 20712-3: 2020 Water Safety Signs and ISO 7010: 2020



1 4273 **K**



1 4275 **EK**



1 4280 **EK**



1 4330 **EK**



1 4232 **GM**



1 4207 **GMEKPK**
2 4207 **G**

Quarry Signs

Full range of signs on page 55.



Material Codes

- 1 Rigid Plastic
- 2 Self Adhesive Vinyl
- 5 Miscellaneous
- 8 Quick Fix

Landscap Sizes

- A 100 x 75mm
- B 80 x 80mm
- F 200 x 200mm
- G 300 x 100mm
- K 400 x 300mm
- O 600 x 200mm
- Q 600 x 450mm
- U 100 x 100mm
- X 200 x 100mm

Portrait Sizes

- E 200 x 150mm
- K 300 x 400mm
- P 400 x 600mm

Warning Signs

Free Standing Signs

Polypropylene - 300 x 600mm - Double Sided Warning - Foldable, Waterproof, Durable and Compact



Lightweight Free Standing Signs

Fluted Polypropylene - 300 x 600mm - Double Sided Warning - Waterproof, Durable, Lightweight and Compact



Custom Free-Standing Signs

These popular double sided, free-standing signs can be customised and personalised to show the warning message you require. They can also be used to promote brand awareness while you work – add your company name and contact details to ensure potential customers know who to contact if they want similar work completed.

To customise these signs in any way simply quote the relevant code and supply the wording/message or image that you require when ordering.

Choose your design and include up to ten words on both sides.



Surface Safety Signs



Caution
Wet floor

1 4223 **GM**
2 4223 **GM**



Caution
Slippery when wet

1 4229 **GM**
2 4229 **GM**



Caution
Mind the step

1 4209 **GM**
2 4209 **GM**
8 4209 **G**

Rigid Plastic A5 (148 x 210mm)	5 8316
Self Adhesive Vinyl A5 (148 x 210mm)	5 8317

Floor Graphic
300 x 100mm
5 8749



Caution
Trip hazard

1 4214 **GM**
2 4214 **GM**
8 4214 **G**



Caution
Sloping floor

1 4521 **G**
2 4521 **G**



Caution
Slippery floor surface

1 4213 **GM**
2 4213 **GM**
8 4213 **G**

Floor Graphic
400 x 600mm
5 8824



Mind your step



Mind your step

Self Adhesive Step Strip
400 x 35mm
5 4035



Caution
Ramp

1 4257 **GM**
2 4257 **G**



Warning
Step steps

1 4492 **G**
2 4492 **G**



Caution
Floor slippery when wet

1 4287 **A**
2 4287 **A**

Floor Preparation

140ml Edge Sealer
5 9699

1 Litre Floor Primer
5 9698

1 Litre Floor Cleaner
5 8827

Anti-Slip Mats

A range of anti-slip mats which are 610 x 150mm in size and include an aggressive pressure sensitive adhesive for bonding to most floor surfaces.



Caution
Watch your Step

5 9634
5 9635



Black / Yellow Chevron

5 9695



Photoluminescent Strip

5 9697





Reflective Strip

5 9696

Pre-Printed Wall Mounted Barriers

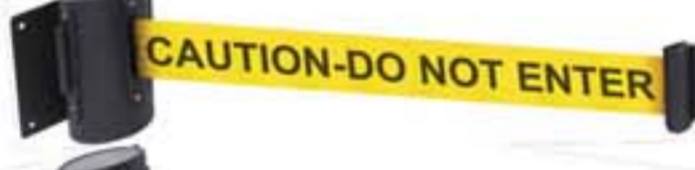
Wall mountable retractable barriers with popular messages printed onto the fabric. A very effective system for restricting access with a choice of belt lengths available.

	3m:	5 9499
	4.6m:	5 9496
	3m:	5 9500
	4.6m:	5 9497
	3m:	5 9501
	4.6m:	5 9498

Cones

500mm high round PVC cones are pre-printed to mark hazardous areas, or we can print a message of your choice.

500mm high triangular cones are manufactured from a UV stabilised LDPE upper and a 100% recycled PVC base for extra stability.

All cones are easily stacked.

Message	Shape	Code
Slippery Surface	Round	5 7980
Floor Cleaning	Round	5 7981
Custom Message	Round	5 7995
Wet Floor	Triangular	5 7982
Custom Message	Triangular	5 7996



Minder Guards

Each minder includes a pack of 6 messages and a stand.

- Caution out of service
- Caution wet floor
- Temporarily closed
- Danger keep out
- Cleaning in progress
- Caution work area

Polyethylene
1030 x 780 x 26mm
5 9637



Cone Attachments



This lightweight ring fits onto round cones; complete with hooks for plastic chain attachment. Use to create a simple barrier solution.
5 7998



Lightweight polyethylene chain with 6mm links. Supplied in 10 metre lengths.

- Red & White | 5 9041
- Black & Yellow | 5 9042

For chain posts and additional barrier systems see pages 70 and 71

Elevator Guard



Designed specifically for elevator maintenance and to comply with BS EN 7255:2001.

Complete modular, 2-panel units that can link together to form larger units. Fold away barrier system made from durable polyethylene plastic. Non-conductive, telescopic poles stored inside the barriers to connect to elevator opening. Lightweight yet extremely strong.

- Suitable for 1300mm openings
- No admittance authorised personnel only
- Each panel 1100 x 660 x 40mm (H x W x D)
- Weight: approx 4kg
- Telescopic poles extend to 2.2m

Polyethylene
1100 x 660 x 40mm
Panels x 2
5 9638

Handi Guards



High quality modular, 3-panel barrier system with a yellow and black stripe and caution symbol as standard. A smooth finish allows easy maintenance and cleaning. Snap on hinges supplied with every panel or set to link panels together.

- Dimensions: 800 x 1000 x 30mm (H x W x D)
- Foldaway for easy storage
- Lightweight – panel weight 2.5kg
- Made from durable polyethylene
- Designed to comply with BS7801:2011 safe working on escalators and moving walkways

Polyethylene
800 x 1000 x 30mm
Panels x 3
5 7984

Material Codes

- 1 Rigid Plastic
- 2 Self Adhesive Vinyl
- 5 Miscellaneous
- 8 Quick Fix

Landscape Sizes

- G 300 x 100mm
- M 600 x 200mm

Portrait Sizes

- A 75 x 100mm
- E 200 x 150mm
- K 300 x 400mm
- P 400 x 600mm

Personal Protective Equipment (PPE) Signs

Employers are responsible for the provision and use of personal protective equipment (PPE) at work. PPE is equipment that will protect the user against health or safety risks at work, it can include items such as safety helmets, gloves, eye protection, high-visibility clothing, safety footwear, safety harnesses and respiratory protective equipment (RPE).

PPE must be properly looked after and stored when not in use. Employees must make proper use of PPE and report if it has been lost, damaged or if any fault is found. Safety signs and posters can prove a useful reminder that PPE should be worn during specific tasks or in specific locations. Take note of any changes in equipment, materials or methods – you may need to update your signs accordingly.

Symbols

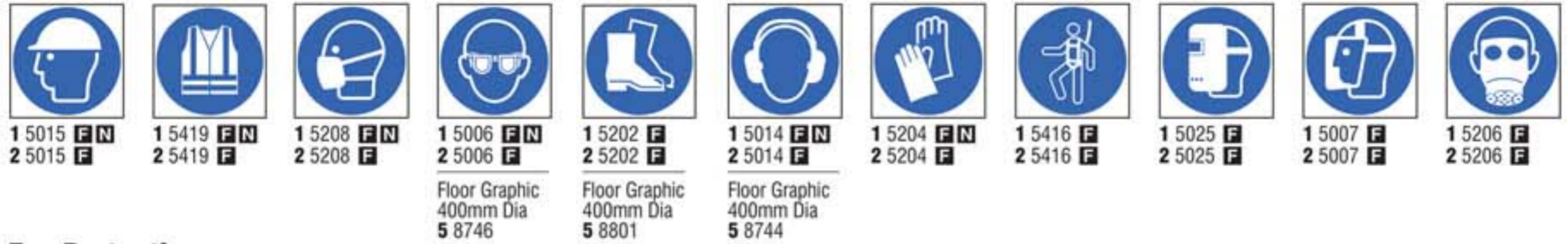

Eye Protection

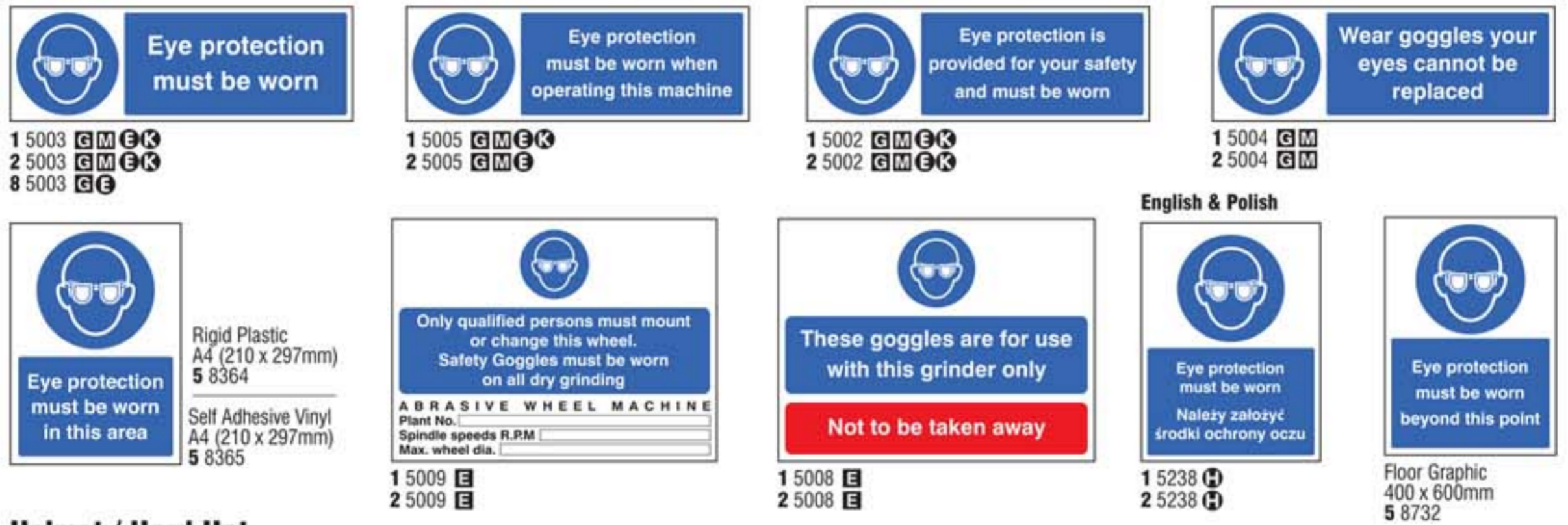

Helmet / Hard Hat



High Visibility Clothing

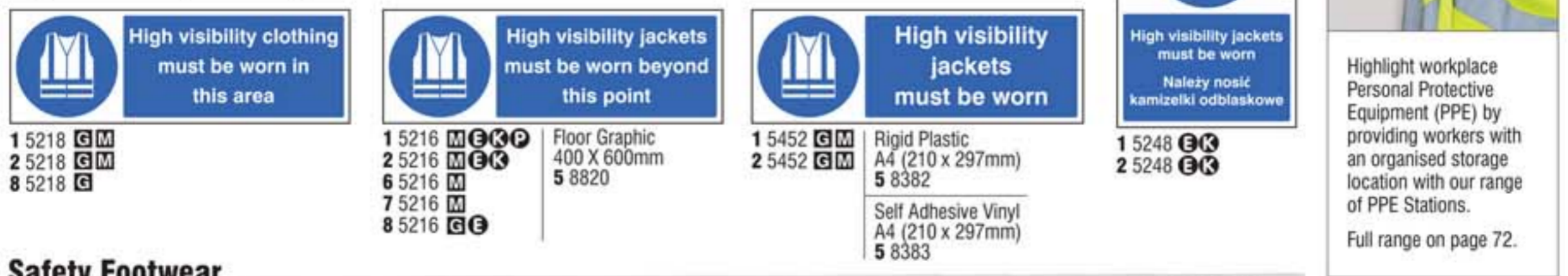

Safety Footwear



Ear Protection

 1 5012 GMEKP 2 5012 GMEK 8 5012 GM	 1 5010 GMEKP 2 5010 GMEK 8 5010 GK	 1 5023 GM 2 5023 GM 8 5023 GM	 1 5011 GMEK 2 5011 GMEK 8 5011 G	
 1 5013 GM 2 5013 GM 8 5013 GM	 1 6250 GMP 2 6250 GM	 1 5222 GM 2 5222 GM 8 5222 G	 1 6251 GM 2 6251 GM 8 6251 G	
 Rigid Plastic A5 (148 x 210mm) 5 8398 Self Adhesive A5 (148 x 210mm) 5 8399	 Floor Graphic 400 x 600mm 5 8731	 1 5219 EK 2 5219 EK	 1 5224 K	 1 5225 HK 2 5225 H

Noise Activated Sign

A highly visible noise activated sign for use where there's a need to indicate when a preset noise level is reached. A great solution where noise levels are intermittent such as factories or music venues.

- Lights up when a preset level is exceeded.
- Quick and simple to install: Wall mount and connect to mains via 5m cable.
- Trigger level: 40dB(A) to 114dB(A) for use in any environment.
- High intensity white LED for high visual impact and a long operating life.

300 x 50mm (Diameter x Depth)
5 8139



Harnesses & Work at Height

 1 5407 GM 2 5407 G	 1 5215 GM 2 5215 G
 1 5504 GM 2 5504 GM	 1 5505 GM 2 5505 GM

Masks & Respirators

 1 5207 GMEK 2 5207 GMEK 8 5207 G	 1 5233 G 2 5233 G	 1 5237 EK 2 5237 EK	 1 5001 GMEK 2 5001 GME
 1 5205 GEK 2 5205 GE	 1 5021 GM 2 5021 GM	 1 5236 EK 2 5236 EK	 1 5203 GMEK 2 5203 GMEK 8 5203 GE

Gloves

 1 5236 EK 2 5236 EK	 1 5203 GMEK 2 5203 GMEK 8 5203 GE
---	---

COVID-19 PPE Signage

We have a range of signs dedicated to the prevention of spreading Coronavirus and the use of face masks and face coverings on pages 138-141.



Clothing & General

 1 5231 G 2 5231 G	 1 5213 GM 2 5213 G	 1 5212 GM 2 5212 GM	 1 5464 G 2 5464 G			
 1 3022 EK	 1 5603 EK 2 5603 EK	 1 5217 EK 2 5217 EK	 Floor Graphic 400 x 600mm 5 8733	 310ml 5 8694	 1 5221 GM 2 5221 GM	 Personal protective equipment is provided for your health and safety and must be used. Defective equipment should be immediately reported to your safety representative. 1 5210 EK 2 5210 EK

Material Codes

1 Rigid Plastic 5 Miscellaneous 7 PET
 2 Self Adhesive Vinyl 6 Aluminium 8 Quick Fix

Landscape Sizes

E 200 x 150mm **G** 300 x 100mm **K** 400 x 300mm **N** 400 x 400mm
F 200 x 200mm **H** 300 x 250mm **M** 600 x 200mm **P** 600 x 400mm

Portrait Sizes

E 150 x 200mm **K** 300 x 400mm
H 250 x 300mm **P** 400 x 600mm

PPE Posters

PPE at Work Regulations 1992

(Personal Protective Equipment)

In situations where risks cannot be controlled by other means such as engineering controls or safe systems of work, employers are required to protect their employees from risks to health and safety by providing suitable personal protective equipment.

What you need to know

What an employer must do

1. Provide suitable protective equipment free of charge
2. Maintain PPE in working order and in good condition
3. Provide relevant training to the use of PPE
4. Consult with employees on the suitability of the PPE to be provided

What an employee must do

1. Use the PPE provided
2. Report any defects, damage or lost PPE
3. Take care to correctly store PPE when not in use

PPE must

1. Be relevant to the work being undertaken
2. Protect effectively against the particular risks involved
3. Conform with relevant standards
4. Fit the user properly and comfortably and adjust where necessary
5. Not reduce the performance of the task or add to the risks involved



Rigid Plastic
400 x 600mm
5 8113

Controlling Noise

What you need to know

Excessive damage to hearing can be caused by exposure to high noise levels. The Control of Noise at Work Regulations 2005 place duties on employers and employees to reduce the risk of damage to hearing at work. Employers must also comply with the requirements of the Act and the orders to be taken.

Employers Must

Reduce the risk of hearing damage to the lowest levels reasonably practicable. Ensure noise assessments are carried out by a competent person. Ensure a record of assessments are kept and re-assessed. Use measures other than ear defenders to reduce exposure to noise. Provide necessary training, instruction and information on risks to hearing and how to minimise them, and ensure ear protection is worn when required. Do not use excessively portable noise warning signs in ear protection areas. Provide hearing checks where noise assessments indicate a risk of hearing loss.

Ensure ear protection is:

- (1) Provided to employees who are at risk
- (2) Provided to all those who are exposed
- (3) Not used by those exposed
- (4) Not kept and maintained to a satisfactory standard

Ensure ear protection is used by all those who enter ear protection areas.

Employees Must

Use the ear protection provided. Use all other protective equipment provided. Report any defects or details found with the ear protection or equipment.

Issue must	Do this	Do not do this
Reduce the risk of hearing damage to the lowest levels reasonably practicable	<input checked="" type="checkbox"/>	<input checked="" type="checkbox"/>
Ensure noise assessments are carried out by a competent person	<input checked="" type="checkbox"/>	<input checked="" type="checkbox"/>
Ensure a record of assessments are kept and re-assessed	<input checked="" type="checkbox"/>	<input checked="" type="checkbox"/>
Use measures other than ear defenders to reduce exposure to noise	<input checked="" type="checkbox"/>	<input checked="" type="checkbox"/>
Provide necessary training, instruction and information on risks to hearing and how to minimise them, and ensure ear protection is worn when required	<input checked="" type="checkbox"/>	<input checked="" type="checkbox"/>
Do not use excessively portable noise warning signs in ear protection areas	<input checked="" type="checkbox"/>	<input checked="" type="checkbox"/>
Provide hearing checks where noise assessments indicate a risk of hearing loss	<input checked="" type="checkbox"/>	<input checked="" type="checkbox"/>
Ensure ear protection is:		
(1) Provided to employees who are at risk	<input checked="" type="checkbox"/>	<input checked="" type="checkbox"/>
(2) Provided to all those who are exposed	<input checked="" type="checkbox"/>	<input checked="" type="checkbox"/>
(3) Not used by those exposed	<input checked="" type="checkbox"/>	<input checked="" type="checkbox"/>
(4) Not kept and maintained to a satisfactory standard	<input checked="" type="checkbox"/>	<input checked="" type="checkbox"/>
Ensure ear protection is used by all those who enter ear protection areas	<input checked="" type="checkbox"/>	<input checked="" type="checkbox"/>
Use the ear protection provided	<input checked="" type="checkbox"/>	<input checked="" type="checkbox"/>
Use all other protective equipment provided	<input checked="" type="checkbox"/>	<input checked="" type="checkbox"/>
Report any defects or details found with the ear protection or equipment	<input checked="" type="checkbox"/>	<input checked="" type="checkbox"/>

Rigid Plastic
400 x 600mm
5 8116

Ear protection must be worn



SITE SAFETY

Synthetic Paper
420 x 594mm
5 7476

Eye protection must be worn



SITE SAFETY

Synthetic Paper
420 x 594mm
5 7474

Safety helmets must be worn



SITE SAFETY

Synthetic Paper
420 x 594mm
5 7473

High visibility jackets must be worn



SITE SAFETY

Synthetic Paper
420 x 594mm
5 7475

Hand protection must be worn



SITE SAFETY

Synthetic Paper
420 x 594mm
5 7477

Safety footwear must be worn



SITE SAFETY

Synthetic Paper
420 x 594mm
5 7479

Dispenser

Remind staff and visitors of their Personal Protection Equipment requirements with our PPE dispenser. Ideal for factories, warehouses and production environments. Our PPE dispenser is made of clear acrylic enabling easy checking of contents and quantities, whilst the hinged lid provides simple access. It can either be placed on a desk or wall mounted.

Dimensions: 240 x 220 x 145mm (HxWxD)
(Contents not included)

 5 5042	 5 5045
 5 5043	 5 5046
 5 5044	



Suspended Frame

All suspended frames come with a suspension kit for easy installation. Simply add two Rigid Plastic signs of your choice back to back and hang the suspended frame from the ceiling. More options on page 52.

Dimensions	White	Blue
300 x 100mm	5 8700	5 8720
600 x 200mm	5 8702	5 8721



Masks must be worn when working here



SITE SAFETY

Synthetic Paper
420 x 594mm
5 7478

Labels

Sheets of six Self Adhesive Vinyl

Available in two sizes. Pre-cut ready to peel.

 50mm Dia 100mm Dia 5 5030 5 5035	 50mm Dia 100mm Dia 5 5031 5 5036	 50mm Dia 100mm Dia 5 5032 5 5037	 50mm Dia 100mm Dia 5 5034 5 5039	 50mm Dia 100mm Dia 5 5033 5 5038	 50mm Dia 100mm Dia 5 5047 5 5048
 5 9716	 5 9711	 5 9715	 5 9712	 5 9717	 5 9714

Rolls of 100 Self Adhesive Vinyl 50 x 50mm Pre-cut ready to peel.

Machinery / Lock Out



Use adjustable guard

1 5406 **G**
2 5406 **G**



Disconnect mains plug when not in use

1 5456 **G**
2 5456 **G**



Refer to instructions before operating this machine

1 5455 **G**
2 5455 **G**



Switch off when not in use

1 5411 **F**
2 5411 **F**

Self Adhesive Vinyl
35 x 25mm
5 5040



Guards must be used

1 5405 **G**
2 5405 **G**



Make sure cylinders are secured at all times

1 5446 **G**
2 5446 **G**



Clean machine after use

1 5447 **G**
2 5447 **G**



Lock out here before working on this equipment

1 6247 **Q**
2 6247 **A**



Lock out point here

1 6248 **Q**
2 6248 **A**



Lock out devices must be used on this equipment during maintenance

1 6246 **Q**
2 6246 **A**



Self Adhesive Vinyl
6 x 65mm Dia
5 1653

Double Sided Tags
10 x Matt PVC - 80 x 150mm
Includes 150mm Cable Ties



Lock out here before working on this equipment

5 5076



Lock out point here

5 5077



Keep right

5 5490



Please use handrail

5 5491

General Mandatory



Keep locked

1 5414 **GM**
2 5414 **GM**



Report all accidents immediately

1 5214 **GM**
2 5214 **G**



Please keep left and hold the handrail

1 5488 **GM**
2 5488 **GM**



Permit to work must be obtained

1 5403 **GM**
2 5403 **GM**



Employees only

1 5469 **G**
2 5469 **G**



Please keep right and hold the handrail

1 5489 **GM**
2 5489 **GM**



Stack correctly

1 5401 **GM**
2 5401 **G**



Lift correctly

1 5420 **GM**
2 5420 **GM**



Use barrier cream whilst on site. UV rays may be harmful to your health

1 5458 **G**
2 5458 **G**



Clean up after your dog
Bag it, tie it, bin it

1 5500 **EK**
2 5500 **EK**



This area is to be kept clear of all obstructions

1 5435 **GM**
2 5435 **GM**



Please use other door

1 7124 **GM**
2 7124 **GM**



Please use other door

1 7123 **GM**
2 7123 **GM**



Keep clear

1 1632 **FGMN** Double Sided Window Sticker
2 1632 **FGMN** 150 x 220mm
5 8251



Use handrail

1 5457 **GM**
2 5457 **GM**
8 5457 **G**



Pedestrians must use this route

1 5428 **GM P**
2 5428 **GM P**
8 5428 **GM**



Pedestrian Route

1 5235 **K**
2 5235 **K**
8 5235 **K**



OUR SIGNAGE IS ISO 7010 COMPLIANT



Shred all documents

1 5639 **GM**
2 5639 **GM**



Shred sensitive documents before placing in bin

1 5640 **GM**
2 5640 **GM**



Place all rubbish in the bins provided

1 5402 **GM**
2 5402 **GM**

Vehicles



Reverse parking only

1 7683 **GM**
2 7683 **GM**



Remove keys from forklift truck when not in use

1 5448 **G**
2 5448 **G**



Sound horn

1 5410 **FN**
2 5410 **F**



Drive slowly

1 5412 **F**
2 5412 **F**



Keep Clear
Electric vehicle recharging point only

1 7848 **HK**
2 7848 **HK**



Wheels must be checked before loading or unloading

1 5466 **GM**
2 5466 **GM**



Switch off all mobile phones

1 5429 **GM**
2 5429 **GM**



Sound horn Drive slowly

1 5413 **GM P**
2 5413 **GM**
8 5413 **G**

Material Codes

- 1 Rigid Plastic
- 2 Self Adhesive Vinyl
- 5 Miscellaneous
- 6 Aluminium
- 7 PET
- 8 Quick Fix

Landscape Sizes

- A 100 x 75mm
- E 200 x 150mm
- F 200 x 200mm
- G 300 x 100mm

- H 300 x 250mm
- K 400 x 300mm
- M 600 x 200mm
- N 400 x 400mm

Portrait Sizes

- Q 600 x 450mm
- P 400 x 600mm

Mandatory Signs

Hygiene Signs

First Aid
Wash your Hands +

When to wash your hands:

- Check one
- Check two
- Check three
- Check four
- Check five
- Check six
- Check seven
- Check eight
- Check nine
- Check ten

Wet your hands with warm water and apply anti-bacterial hand cleaning gel or disinfectant hand wash then follow the instructions below. (Dilute if not stated according to FSI 2502)

1 Rub together palms

2 Rub the palm of your hand over the back of the other hand, interlocking fingers

3 Rub the palm of your hand over the fingers of the other hand

4 Rub the back of your hand against your palm with fingers interlocked

5 Rub the back of your hand against your palm with fingers crossed

6 Rub the palm of your hand against the back of the other hand, interlocking fingers

7 Rub the palm of your hand against the back of the other hand, with fingers crossed

8 Rub the thumb against the palm of the other hand

9 Rub the thumb against the palm of the other hand

10 Rub the thumb against the palm of the other hand

Remember: Washing your hands with soap and water takes about 20 seconds.

Synthetic Paper
420 x 594mm
5 5917

Now wash your hands

1 5408 **GM**
2 5408 **GM**
8 5408 **GA**

Use hand sanitiser

1 5418 **GM**
2 5418 **GM**

Please wash only hands here

1 5602 **E**
2 5602 **EK**

Prevent the spread of flu

Catch it
Cover your nose and mouth with a clean tissue when you cough or sneeze.

Bin it
Dispose of used tissue in your nearest bin.

Kill it
Washing your hands and cleaning surfaces prevents the spread of germs.

2 5503 **E**

Please flush the toilet after use

1 5487 **GE**
2 5487 **GE**

Please wash your hands after going to the toilet

1 5424 **G**
2 5424 **G**

Prevent the spread of flu

Dispose of used tissues in bins provided

2 5502 **E**

Prevent the spread of flu

Wash your hands frequently

2 5501 **E**

1 5409 **F**
2 5409 **F**

6 x Stickers
65mm Diameter
5 1654



Catering Signs

Hairnets must be worn

1 5627 **GM**
2 5627 **G**

Hair protection must be worn

1 5606 **G**
2 5606 **G**

All handlers of food must wash their hands after visiting the toilet

1 5610 **G**
2 5610 **G**

This basin is for hand washing only

1 5451 **G**
2 5451 **G**

Raw meats only

1 5611 **G**
2 5611 **G**

Raw vegetables only

1 5628 **G**
2 5628 **G**

Cooked meats only

1 5608 **G**
2 5608 **G**

Keep raw meats and fish at bottom of fridge

1 5613 **G**
2 5613 **G**

Keep these premises tidy

1 5404 **GM**
2 5404 **GM**

Maintain your workstation in a tidy condition at all times

1 5449 **G**
2 5449 **G**

All food must be covered

1 5621 **G**
2 5621 **G**

Please keep surfaces clean and tidy

1 5622 **G**
2 5622 **G**

You are entering a food production area

Wash your hands

1 5620 **GM**
2 5620 **GM**

No smoking

You are entering a food production area

1 5619 **G**
2 5619 **G**

This is a food production area

In the interest of hygiene protective garments must be worn

1 5605 **G**
2 5605 **G**

Clean up spillages

1 5427 **GM**
2 5427 **GM**

Please wash only food equipment here

1 5601 **E**
2 5601 **EK**

This is a food production area

Protective clothing must be worn

Wash your hands before commencing work

1 5604 **EK**
2 5604 **EK**

Chilled and frozen foods

- Check conditions of all deliveries - load and record temperatures
- Refrigerate immediately after each delivery
- Check and record all refrigeration temperatures regularly

Caution
Failure to comply with food quality and safety procedures will result in disciplinary action being taken

1 5626 **K**
2 5626 **K**

Work safely with cookers & ovens

Always use the protective clothing/equipment provided. Wash out hot oil/ grease and liquids after switching hot food. Turn off the work top/ gas and allow to cool before cleaning. Report all damage when not in use. Report all faults immediately to the supervisor.

Do not:

- Use this equipment unless trained and authorized to do so.
- Single lift or use unless you are trained to do so.
- Use any equipment that is damaged or defective.

Caution
Hot surfaces and liquids

1 5625 **K**
2 5625 **K**



Catering Best Practice Signs

PREVENT CROSS CONTAMINATION

USE CORRECT COLOUR CODED CHOPPING BOARDS & KNIVES

RAW MEAT

RAW FISH

COOKED MEATS

SALADS & FRUITS

VEGETABLES

DAIRY PRODUCTS

FOOD HYGIENE ACT 1995

1 5616 **H**
2 5616 **H**

THE SAFE USE OF KNIVES

Always select the right knife for the task.

Knives should be kept sharp and have handles that can be properly held.

When using a knife, use a firm grip, try to use even pressure for cutting, cut downwards and avoid cutting towards the body.

Never try to catch a falling knife.

Knives should not be left lying around on worktops and tables. They should not be placed unprotected in cupboards or drawers, nor left in washing up water. They should always be stored in suitable sheaths or racks.

Cutting blocks, tables and boards should be firm, smooth and clean.

There should always be enough room so that a person using a knife is not in danger of being bumped by another person.

When carrying a knife always hold the point of the knife downwards.

1 5617 **H**
2 5617 **H**

FOOD SAFETY CHECKLIST

Always wash your hands between handling raw and cooked meat products

Report any illness like diarrhoea, vomiting or infected cuts.

Ensure that there is enough room to separate raw food from cooked or ready to eat foods

Avoid cross-contamination

Health, surfaces, equipment and utensils use all optimal points from raw to cooked food. Clean them thoroughly.

Maintain Temperature Controls

Check all fridges and freezers operate in the correct temperature

Always keep raw meats and fish at bottom of fridge

All hot food served above 63°C

All reheated food should reach 82°C

1 5614 **P**
2 5614 **P**

CATERING HYGIENE

PERSONAL HYGIENE

1. Always wash your hands with soap and water for at least 20 seconds before and after handling raw and cooked meat products, and before and after handling food for service, including ready to eat food.

2. Always use hand sanitiser when your hands are not soiled, and you cannot get to a sink to wash.

3. Always wear clean protective clothing, including aprons, and a clean hairnet or cap.

4. Always wear clean protective footwear, including wellies or boots, and clean them when they are soiled.

FOOD SAFE EQUIPMENT

1. Always use clean and well-maintained equipment for the preparation of food.

2. Always use clean and well-maintained equipment for the preparation of food, including cutting boards and knives.

3. Always use clean and well-maintained equipment for the preparation of food, including cutting boards and knives.

4. Always use clean and well-maintained equipment for the preparation of food, including cutting boards and knives.

5. Always use clean and well-maintained equipment for the preparation of food, including cutting boards and knives.

1 5618 **H**
2 5618 **HP**

Food Allergy Signs

































Caution Allergy Warning

Restaurants and food outlets are required to display details of allergens contained within their menu. We have a range of signs dedicated to highlighting potential food allergies. See page 32 for more info.

First Aid Signs

Under the Health and Safety (First Aid) Regulations 1981 (as amended 1997) employers have a legal obligation to assess and introduce first aid provisions. Any such provisions should be easy to locate and displaying ISO 7010 compliant signage offers the perfect solution.

Add a Hook: See page 42.

 <p>1 6002 H 2 6002 H 8 6002 H</p> <p>Rigid Plastic A4 (210 x 297mm) 5 8384</p> <p>Self Adhesive Vinyl A4 (210 x 297mm) 5 8385</p>	 <p>1 6019 H 2 6019 H 8 6019 H</p>	 <p>1 6018 H 2 6018 H</p>	 <p>1 6038 EK 2 6038 EK</p>	 <p>1 6076 K 2 6076 K</p>		
 <p>1 6004 H 2 6004 H 8 6004 H</p> <p>Adapt-a-Sign 215 x 310mm 5 6004</p>	 <p>1 6027 H 2 6027 H 8 6027 H</p> <p>Adapt-a-Sign 215 x 310mm 5 6027</p>	 <p>1 6022 H 2 6022 H</p> <p>Adapt-a-Sign 215 x 310mm 5 6022</p>	 <p>1 6023 H 2 6023 H</p> <p>Adapt-a-Sign 215 x 310mm 5 6083</p>	 <p>1 6029 H 2 6029 H</p>	 <p>1 5999 H 2 5999 H</p>	
 <p>1 5995 H 2 5995 H</p>	 <p>1 5994 H 2 5994 H</p>	 <p>1 5997 H 2 5997 H</p>	 <p>1 6053 H 2 6053 H</p>	 <p>1 6052 H 2 6052 H</p>	 <p>1 5998 H 2 5998 H</p>	
<p>Adapt-a-Signs A cost effective sign solution that ensures sign details remain up to date at all times. Manage any changes in personnel by simply inserting a new A4 piece of paper with updated details.</p> 	 <p>1 6020 H 2 6020 H</p>	 <p>1 6028 H 2 6028 H</p>	 <p>1 6001 H 2 6001 H</p>	 <p>1 6003 H 2 6003 H 8 6003 H</p>		
 <p>1 6012 GM 2 6012 G</p>	 <p>1 6013 GM 2 6013 G</p>	 <p>1 2147 GL 2 2147 GL 3 2147 L</p>	 <p>1 6014 GM 2 6014 GM 8 6014 G</p>			
 <p>1 6024 FU 2 6024 FU</p>	 <p>1 6026 FU 2 6026 FU</p>	 <p>1 6025 F 2 6025 F</p>	 <p>1 6016 F 2 6016 F</p>	 <p>Self Adhesive Vinyl 50 x 50mm: 5 6084 25 x 25mm: 5 6085</p>	 <p>1 6010 GM 2 6010 GM</p>	 <p>1 6015 GM 2 6015 GM</p>

Site Saver First Aid Signs

Fluted polypropylene is a 100% recyclable, 4mm thick, low-cost material which is perfect for temporary site signage. It is strong, lightweight and waterproof. All of our site saver signs include the option to add your company logo. See the full range on page 126 - 127.



	 <p>400 x 400mm 5 5727</p>	 <p>400 x 400mm 5 5728</p>	 <p>400 x 400mm 5 5729</p>	 <p>600 x 400mm 5 5781</p>
---	---	---	--	---

Directional Indicator

Supplementary arrows may be used in combination with first aid signs to communicate the location of the equipment.

To avoid confusion with directional emergency escape and safety way guidance, ISO 7010 style arrows should not be used for indicating the direction to equipment.



- 1 5996 **ADS**
- 2 5996 **ADS**
- 3 5996 **ADS**
- 4 5996 **ADS**

Material Codes

- 1 Rigid Plastic
- 2 Self Adhesive Vinyl
- 5 Miscellaneous
- 6 Aluminium
- 7 PET
- 8 Quick Fix

Landscap Size

- E 200 x 150mm
- F 200 x 200mm
- G 300 x 100mm
- H 300 x 250mm
- K 400 x 300mm
- L 450 x 150mm
- M 600 x 200mm
- U 100 x 100mm

Portrait Sizes

- A 75 x 100mm
- D 100 x 150mm
- E 150 x 200mm
- H 250 x 300mm
- K 300 x 400mm
- P 400 x 600mm
- S 75 x 200mm

First Aid Signs

Emergency Wall Panels

These wall panels can be fitted to any surface using hook and loop tabs. The grab handle enables easy removal, providing first aiders 'on the spot' treatment advice.

Response Isolate casualty from obstructions in the mouth. If breathing, place the head backwards as far as it will go and lift chin. This will open the air passage behind the tongue.

4 Airways Loosen neck wear. Tilt casualty head backwards as far as it will go and lift chin. This will open the air passage behind the tongue.

5 Observe Maintain position as above and look and listen for breathing for no more than 10 seconds. Look down the chest to check for movement. Look for signs of circulation i.e. breathing.

6 Breathing Place in recovery position.

Not Breathing - Phone 999

- Use the heel of your hands in the centre of the chest.
- Interlock the fingers of your hands and en...
- Start chest compressions at a rate of 100...
- Using your body weight, press straight d...

Emergency Resuscitation Treatment for Adults

- 1 Immediately** Call for help. Switch or turn off Electricity, Gas or Water at the source.
- 2 Electric Shock** Remove casualty from danger, if electrical supply cannot be switched off, stand on and use non-conductive materials to remove casualty from electrical contact.
- 3 Response** Check if the casualty is conscious. If unconscious remove any obvious obstructions to the mouth. If breathing, place the casualty into the recovery position.
- 4 Airways** Loosen neck wear. Tilt casualty's head backwards as far as it will go and lift chin. This will open the air passage behind the tongue.
- 5 Observe** Maintain position as above. Look and listen for breathing for no more than 10 secs. Look down the chest to check for movement indicating breathing. Look for signs of circulation i.e. breathing, colour or coughing.
- 6 Breathing** Place in recovery position and treat any life threatening injuries.

!! Not Breathing - Phone 999 for an ambulance !!

- Use the heel of your hands in the centre of the victim's chest.
- Interlock the fingers of your hands and ensure pressure is not applied over the patient's ribs.
- Start chest compressions at a rate of 100 - 120 times a minute.
- Using your body weight, press straight down by 5cm on their chest. Keep your hands in position, release the compression and allow the chest to return to its original position.
- After 30 compressions repeat the whole thing again using head tilt and chin lift.
- Push the victim's nose closed.
- Seal your mouth over theirs and blow steadily and firmly for about 1 second.
- Give 2 rescue breaths whilst waiting for the ambulance to arrive.
- Continue with compressions and rescue breaths in a ratio of 30:2.

Doctor: _____
Ambulance: _____
Nearest First Aid: _____

Rigid Plastic
450 x 600mm
5 6080

Electric Shock Emergency Action

- Switch off power.
- Call for assistance.
- If power cannot be switched off, avoid or pull the casualty clear of the electrical source, using any dry, non-conductive material to help you.
- Check for responsiveness. If unconscious remove any obvious obstructions to the mouth and proceed immediately with Emergency Resuscitation Treatment.

- Loosen neck wear. Tilt casualty's head backwards as far as it will go and lift chin. This will open the air passage behind the tongue.
- Observe position as above. Look and listen for breathing for no more than 10 seconds.
- Look for signs of circulation i.e. breathing, colour or coughing.
- If not breathing, phone 999 for an ambulance. If breathing, place the casualty into the recovery position.
- Use the heel of your hands in the centre of the victim's chest. Interlock the fingers of your hands and ensure pressure is not applied over the patient's ribs. Start chest compressions at a rate of 100 - 120 times a minute. Using your body weight, press straight down by 5cm on their chest. Keep your hands in position, release the compression and allow the chest to return to its original position. After 30 compressions repeat the whole thing again using head tilt and chin lift. Push the victim's nose closed. Seal your mouth over theirs and blow steadily and firmly for about 1 second. Give 2 rescue breaths whilst waiting for the ambulance to arrive. Continue with compressions and rescue breaths in a ratio of 30:2.

Doctor: _____
Ambulance: _____
Nearest First Aid: _____

Rigid Plastic
450 x 600mm
5 6081

Burns and Scalds

- Place the burnt area under cold running water immediately for at least ten minutes. If it is a serious burn ensure an ambulance is called.
- If possible remove any items that may prevent swelling to burnt area: belts, boots, watches or rings.
- Place a clean, sterile dressing over the burnt area.
- Check that if required an ambulance has been called and check that the accident has been reported to the correct individuals.

DO NOT

- DO NOT apply any butter, oil, ointment or cream.
- DO NOT attempt to remove any form of clothing that may be sticking to the burnt area.
- DO NOT touch or place anything other than a sterile dressing on a burn.
- DO NOT burst any blisters that may form on or around the wound.

Doctor: _____
Ambulance: _____
Nearest First Aid: _____
Nearest A&E: _____

Rigid Plastic
450 x 600mm
5 6082

Mental Health & Wellbeing

Help raise awareness of mental health and wellbeing amongst employees in the workplace. Produced on tough, wipe clean synthetic paper. Suitable for internal and external use.



1 in 4
of us will face
mental health problems
this year

Surprisingly common isn't it?
You'll probably find that the person you open up to has suffered too!

Synthetic Paper
420 x 594mm
5 7099

1 in 4
of us will face
mental health problems
this year

Taking steps to
a healthier workplace
and a healthier mind

Synthetic Paper
420 x 594mm
5 7100

1 in 4
of us will face
mental health problems
this year

What can you do
when you don't feel ok?
Talk to someone!

Synthetic Paper
420 x 594mm
5 7097

1 in 4
of us will face
mental health problems
this year

Let's change the way we
think and act about mental health!
It's nothing to feel ashamed about!

Synthetic Paper
420 x 594mm
5 7098

First Aid Projecting Signs

This range of first aid projecting signs enables the first aiders' to identify locations of First Aid equipment from several view points quickly and easily. These projecting signs have been designed to conceal the fixings for a neat finish and are supplied ready to install with an easy drilling guide.



5 6093

5 6087

5 6088

5 6089

5 6090

5 6086

5 5927

First Aid Box Tamper Labels

An easy-break label to clearly identify when a first aid box has been opened. Helps ensure first aid box remains fully stocked.

Open Indicator
Position perforations over box opening

If seal is broken, please check contents. Refill as required.

82 x 23mm
Roll of 50
5 6300



First Aid Box Tamper Tag

Tamper proof tags can be attached to first aid kits or fire extinguishers, quickly and easily to ensure that the contents inside are kept safe and deters misuse but it also offers easy access in case of an emergency. Once broken, the tag cannot be re-closed which helps to identify any case of unauthorised use. The bright yellow design ensures it is easily seen.

300mm Length
5 1100



Reflective First Aid Armband

Identify first aid personnel quickly with this reflective first aid armband. Hook and loop fastening. One size fits all.

Adjustable to fit: 90 - 130mm diameter.
5 6469



Wall Hanging Hook

Manufactured from a strong black polypropylene plastic. Suitable for holding most first aid kits by the handle. The hook includes two drill holes for easy fixing (screws not included). Helps to make first aid kits easily visible and accessible in the workplace.

55 x 60 x 80mm
5 5933



First Aider Hi-Vis PPE Station

Store and display your hi-vis first aider waistcoat and / or armband on this handy PPE station.

Provide instant access to PPE in the event of an emergency situation and ensure everybody knows that you are the qualified first aider at the scene.



The Foam Board is easily drilled for wall mounting.

Includes

A strong black polypropylene hook from which to hang the relevant PPE (PPE not included).

- 10mm Foam Board
- 80 x 160mm
- 5 5936

To view the full range of PPE stations go to page 72. Customised versions are available upon request.

First Aid Station

Locate essential information and equipment in one place, this First Aid Station can save time in the event of an emergency.

Includes

General advice covering treatment of common injuries and emergencies.

First aid box holder to hang your first aid kit (not included) which displays a "missing" message if the box is not in place

First aiders notice to help identify those trained to administer first aid

Accident report book holder and A4, GDPR compliant report book which includes 50 accident/report forms

- 10mm Foam Board
- 900 x 700mm
- 5 5935



Accident Report Book

50 individual records, all on perforated paper to enable confidentiality.



In line with the Data Protection Act 2018 and GDPR, this A4 book enables the record of an accident/incident relating to any individual to be easily removed from the main book and stored securely in an employee's private records.

- 5 6095

Accident Report Book Station

This wall mounted station ensures that the accident book is clearly visible at all times and is easy to access in case of an emergency. The station helps to overcome the frequent issue of Accidents Books being misplaced or not close to hand following an accident and therefore a record not being completed.

The station is pre-drilled for easy mounting and includes a printed "missing" message to show if / when the log book has been removed.

- 3mm Rigid Plastic
- 360 x 220 x 15mm
- 5 5934



Face Adhesive Labels

Apply these face adhesive labels to glass and view / read from the other side.



- 300 x 50mm
- 5 6096



- 100 x 75mm
- 5 6037

Rigid Dry-Wipe Signs

A range of signs with a specialist dry-wipe surface which allows the sign to be updated whenever required with a water based dry-wipe pen and a dry-wipe eraser.



- 400 x 300mm 5 4710
- 600 x 450mm 5 4713



- 300 x 400mm 5 4702
- 450 x 600mm 5 4706

Our full range of Dry-Wipe signs are available on page 60.



Self Adhesive Labels

A sheet of six self-adhesive vinyl labels. Pre-cut, ready to peel from the backing sheet.



- Sheet of 6
- 65mm Dia
- 5 6100



- Sheet of 6
- 65mm Dia
- 5 6094

Custom Signs

With a team of talented designers and several printing processes and a large variety of materials, we're able to provide the ideal sign solution for any environment.

Call us for a quote



Safe Condition Signs



- 1 6055 AEH
- 2 6055 AEH
- 8 6055 E



- 1 6005 AEH
- 2 6005 AEH
- 8 6005 E



- 1 6007 AEH
- 2 6007 AEH
- 8 6007 E



- 1 6051 K
- 2 6051 K



- 1 6035 K
- 2 6035 K



- 1 6515 G
- 2 6515 G



- 1 5459 GM
- 2 5459 GM



- 1 6034 K
- 2 6034 K



- 1 6593 K
- 2 6593 K

Material Codes

1 Rigid Plastic 2 Self Adhesive Vinyl 5 Miscellaneous 8 Quick Fix

Landscape Sizes

G 300 x 100mm K 400 x 300mm M 600 x 200mm

Portrait Sizes

A 75 x 100mm E 150 x 200mm H 250 x 300mm

First Aid Posters Synthetic Paper - 420 x 594mm

Ensure staff and visitors are aware of first aid procedures with this informative range of posters. Useful reference tools for first aiders. Produced on tough, durable, wipe-clean synthetic paper which rolls up for simple storage but won't easily tear or delaminate. Suitable for both internal and external use.



First Aid

Resuscitation for Children (0-15yrs)

This information is for guidance purposes only and should not be used as a substitute for recognised first aid courses.

RESPONSE

- Walk around the child and announce that you are a First Aider and are here to help.
- Clearly shake the shoulders and say loudly into both ears "Can you hear me?"

OPEN AIRWAY AND CHECK FOR BREATHING

- Place your palm on their forehead and with two fingers under the point of the chin gently lift the head back. Do not push on the soft tissue under the chin. This infant ensure a neutral head position and apply chin lift.
- Check the mouth for any obstructions e.g. breast, chewing gum or loose teeth.
- Put your ear close to the child's mouth whilst looking down at the chest. Wait for 10 seconds whilst looking for chest movements, listening for breathing sounds and feeling for air movements on your cheeks.

CALL FOR HELP

EMERGENCY CONTACT:

5 5907

First Aid

Resuscitation

This information is for guidance purposes only and should not be used as a substitute for recognised first aid courses.

RESPONSE

- Walk around the casualty and announce that you are a First Aider and are here to help.
- Clearly shake the shoulders and say loudly into both ears "Can you hear me?"

OPEN AIRWAY AND CHECK FOR BREATHING

- Place your palm on their forehead and with two fingers under the point of the chin gently lift the head back.
- Check the mouth for any obstructions e.g. chewing gum or loose teeth.
- Put your ear close to the casualty's mouth whilst looking down at the chest. Wait for 10 seconds whilst listening, feeling and looking for the chest rising up and down.

CALL FOR HELP

EMERGENCY CONTACT:

5 5900

First Aid

Choking Treatment

This information is for guidance purposes only and should not be used as a substitute for recognised first aid courses.

SYMPTOMS OF CHOKING

- Highly distressed
- Coughing
- Gagging
- Heaving towards or holding throat
- Unable to, or finding it difficult to, talk / breathe
- Turning blue
- Excessive loss of consciousness

DO NOT:

- Use the backblow if the patient is a baby.
- Insert fingers into the mouth as this may cause the foreign body to lodge further up the airway.

CAUSES OF CHOKING

- Foreign object or food stuck in or covering the windpipe
- Muscular spasm

TREATMENT

IF THAT FAILS:

IF THE OBSTRUCTION IS STILL THERE:

LOSS OF CONSCIOUSNESS

CHILDREN

EMERGENCY CONTACT:

5 5904

First Aid

Electric Shocks

This information is for guidance purposes only and should not be used as a substitute for recognised first aid courses.

RESPONSE

- Walk around the casualty and announce that you are a First Aider and are here to help.
- Clearly shake the shoulders and say loudly into both ears "Can you hear me?"

OPEN AIRWAY AND CHECK FOR BREATHING

- Place your palm on their forehead and with two fingers under the point of the chin gently lift the head back.
- Check the mouth for any obstructions e.g. chewing gum or loose teeth.
- Put your ear close to the casualty's mouth whilst looking down at the chest. Wait for 10 seconds whilst listening, feeling and looking for the chest rising up and down.

CALL FOR HELP

EMERGENCY CONTACT:

5 5905

First Aid

Burn Treatment

This information is for guidance purposes only and should not be used as a substitute for recognised first aid courses.

TYPE OF BURN AND POSSIBLE CAUSES:

BURN DEPTH - FULL THICKNESS

BURN DEPTH - PARTIAL THICKNESS

CHEMICAL BURN TREATMENT

SEEK MEDICAL ADVICE OR REFER TO A HOSPITAL IN THE FOLLOWING SITUATIONS:

EMERGENCY CONTACT:

5 5906

First Aid

Wash your Hands

This information is for guidance purposes only and should not be used as a substitute for recognised first aid courses.

When to wash your hands:

- Hands look or feel dirty
- After using the toilet
- Before eating a meal or snack
- Before and after food preparation
- After contact with bodily fluids, broken skin, wounds and/or animal droppings
- After coughing, sneezing, nose blowing
- After opening and type of gloves
- Before and after contact with human fluids
- Handling raw or uncooked food up to other food use

Wet your hands with warm water and apply anti-bacterial hand cleaning gel or disinfectant hand wash then follow the instructions below. (Standard rub method according to EN 1500)

- Rub hands palm to palm. Don't forget to rub the back of your other palm
- Place the palm of your hand into the back of your other palm
- Rub hands palm to palm with fingers interlocked
- Back of fingers to opposing palm with fingers interlocking
- Rotational rubbing of right thumb across all palm area
- Rotational rubbing backhand of right hand against left palm (left hand repeat)

Remember: If using soap and water then hands under running water and dry thoroughly

EMERGENCY CONTACT:

5 5917

First Aid

General First Aid

This information is for guidance purposes only and should not be used as a substitute for recognised first aid courses.

REMEMBER:

BREATHING

GASping

BURNS / SCALDS

CHEMICAL BURNS

ELECTRIC SHOCK

SEVERE BLEEDING

EMERGENCY CONTACT:

5 5901

First Aid

Eye Treatment

This information is for guidance purposes only and should not be used as a substitute for recognised first aid courses.

BLOW TO THE EYE

FOREIGN BODY IN THE EYE

CHEMICAL BURN TO THE EYE

WOUNDED EYE

EMERGENCY CONTACT:

5 5902

First Aid

Hand Treatment

This information is for guidance purposes only and should not be used as a substitute for recognised first aid courses.

SPRAINS AND STRAINS

MINOR CUTS

BLISTERS

MINOR HEAT BURNS

SUSPECTED BROKEN BONES

CHEMICAL BURNS

EMERGENCY CONTACT:

5 5903

Our range of eye-catching safety posters are a perfect solution to businesses wanting to display specific health and safety guidance / advice to a wider audience. We always recommend the regular rotation of posters to keep your displays fresh and interesting to staff, increasing the potential for posters being read. You will find a range of frame options on page 52 to help protect and further highlight the poster on display.

Posters with the logo next to them include a QR code, which can be scanned for additional free video content.

First Aid Posters

Synthetic posters are printed on an eco-friendly, PVC-free material that has excellent scratch, tear and water resistance properties.



The **YouTube** logo indicates that the poster includes a QR code, which when scanned provides additional free video content.

First Aid

Electric Shocks



Rampage
1. Turn off the power at the main switch or disconnect the power at the source.
2. Do not touch the victim or the power source directly.
3. Use a non-conductive object to move the victim away from the power source.
4. Call for medical help.

Response
1. Check for responsiveness.
2. If unresponsive, shout for help and someone to call the ambulance.
3. Place the victim on a hard surface (like a floor) and check for breathing.
4. If not breathing, start CPR.

Alway
1. Do not touch the victim or the power source directly.
2. Use a non-conductive object to move the victim away from the power source.
3. Call for medical help.

Chest Compression
1. Place the victim on a hard surface (like a floor).
2. Kneel beside the victim.
3. Place the heel of your hand on the center of the victim's chest.
4. Push hard and fast, about 2 inches (5 cm) deep, at a rate of 100 to 120 compressions per minute.

Other Injuries
1. Do not move the victim unless necessary.
2. Control bleeding with direct pressure.
3. Do not remove any objects embedded in the body.
4. Do not give the victim anything to eat or drink.

Setting Help
1. Call for medical help.
2. Provide first aid until help arrives.
3. Do not give up.

594 x 420mm
5 8999

First Aid

Pandemic Flu

This poster sets out simple and generic guidance to reduce the spread of the flu virus.

Signs & Symptoms
1. Sudden onset of fever and cough.
2. Sudden onset of sore throat.
3. Sudden onset of muscle aches and pains.
4. Sudden onset of fatigue.

How Does The Virus Spread?
1. Through the air when someone coughs or sneezes.
2. Through contact with someone who is infected.
3. Through contact with surfaces that have been touched by someone who is infected.

Prevention & Control
1. Avoid close contact with people who have the flu.
2. Avoid touching your eyes, nose, and mouth.
3. Wash your hands frequently with soap and water.
4. Use tissues to cover your nose and mouth when you cough or sneeze.
5. Stay home if you are sick.

594 x 420mm
5 8138

Document Holders 10mm Foam Board - 440 x 600mm

Keep important safety documents in a clearly displayed and readily available place. This range of document displays help companies organise their important documents and help staff remain informed and up to date regarding all workplace information. Signs are supplied with a clear polystyrene document holder.



5 8218

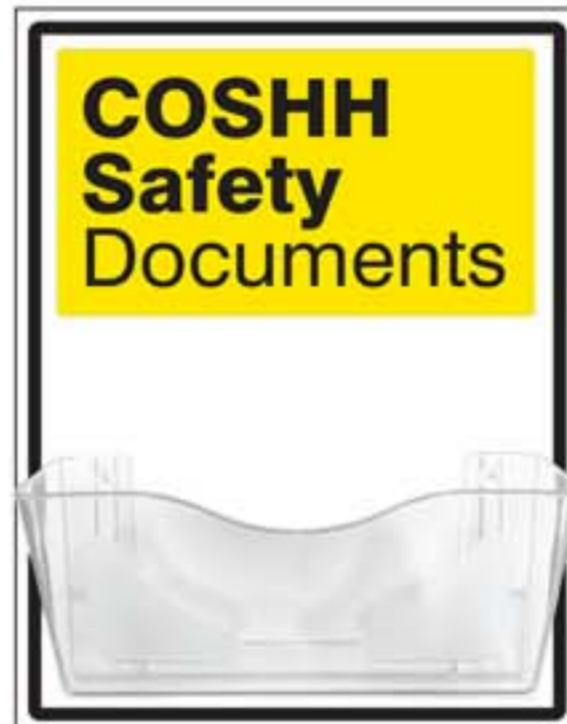

5 8214



5 8213



5 8216

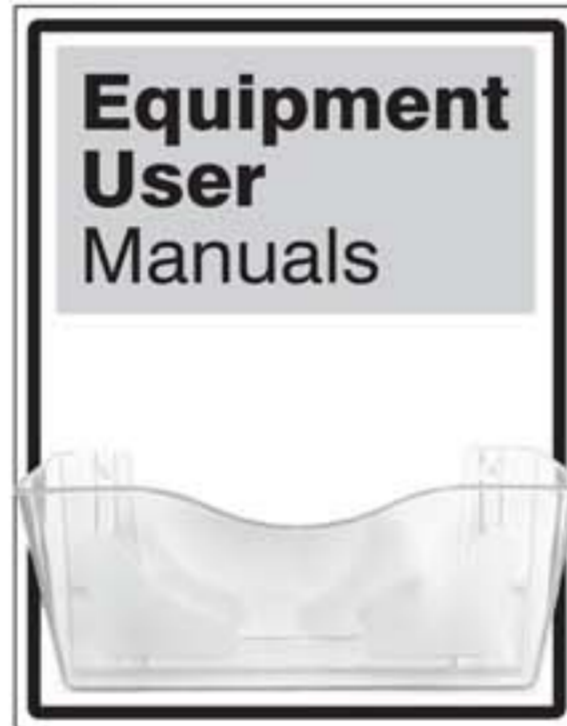

5 8217

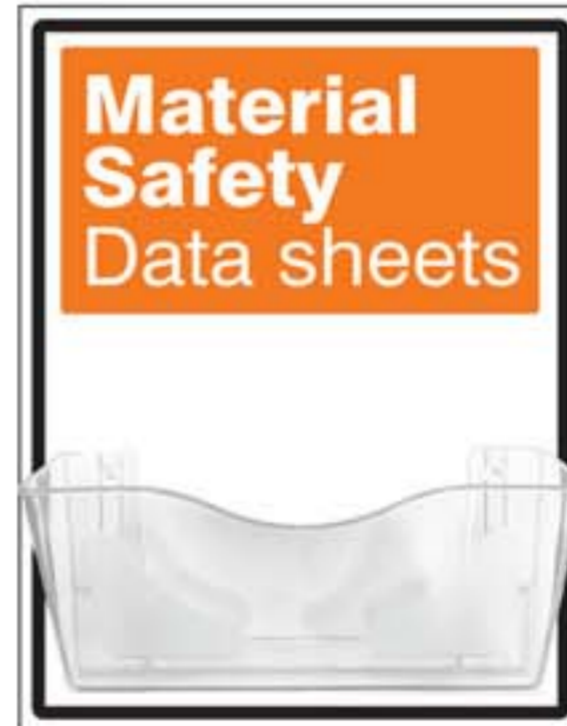

5 8215

Document Holder



A durable clear polystyrene holder which is perfect for storing A4 ring binders and other A4 document wallets. It is pre-drilled for easy wall mounting using the supplied fixing kit.

380 x 180 x 105mm (W x H x D)
Polystyrene
5 9899

Permits to Work



Permits to Work are an integral part of a Health and Safety Management System. They include risk assessments to ensure that only competent staff are working on the identified hazards.

Permits contain three parts (original, plus two carbon copies for management records) with a useful card backing sign.

5 8170 Hot Works 5 8173 Work at Height
5 8171 Electrical Works 5 8174 Hazardous Substances
5 8172 Confined Spaces 5 8175 General Works

Book Holder Stations

These wall mounted book holding stations ensure that important log books are clearly visible and help to overcome the frequent issue of books being misplaced. The station is pre-drilled for easy mounting and includes a printed "missing" message to show when the log book has been removed. Books are sold separately.



5 5934



5 8203



5 5938

Report Books



5 6095 Accident Report Book
5 8061 Fire Log Book
5 5937 Near Miss Report Book

Symbols, Identification and Construction Sites

Get to know Safety Sign Designs

The Health & Safety (Signs and Signals) Regulations 1996

These regulations cover the design principles for communicating health and safety information and requirements for employers to provide safety signs in a variety of situations where there is a significant risk to health and safety which has not been avoided or controlled satisfactorily by other methods.

Prohibition Signs (No No)
Signs prohibiting certain behaviours or actions which should not be permitted within certain areas e.g. No Smoking. Incorporates a red circle with a diagonal line, a black ISO 7010 symbol and supplementary text (white on red) can be added.

Warning Signs (Danger / Warning / Caution)
Advise of a potential threat or hazard to health or safety e.g. Danger, High Voltage. Incorporates a yellow triangle with a black border and black ISO 7010 symbol. Supplementary text (black on yellow) can be added.

Mandatory Signs (You must)
Indicates a course of action to be followed or equipment to be used e.g. Protective footwear must be worn. Incorporates a blue circle with a white ISO 7010 symbol and supplementary text (white on blue) can be added.

Safe Condition Signs (Safety way)
Signs giving information about safe conditions, doors, first aid and escape routes e.g. First aid box. Incorporates a green square with a white ISO 7010 symbol and supplementary text (white on green) can be added.

Fire Signs (Fire Fighting Equipment)
Signs indicating and advising of the location of fire fighting equipment and personnel e.g. Fire alarm. Incorporates a red square with a white ISO 7010 symbol and supplementary text (white on red) can be added.

Rigid Plastic
400 x 600mm
5 8118

Get to know these Safety Sign Symbols

The Health and Safety (Safety Signs and Symbols) Regulations

Employers need to ensure that their staff receive training in the meaning of safety signs. The symbols shown are the most common used for health and safety and are internationally recognised. The symbols are smaller than ISO 7010.

Prohibition indicates an action or behaviour that must not be carried out.

Mandatory indicates a course of action to be followed or equipment to be used.

Warning indicates a potential threat or hazard to health within an area.

Safe Condition indicates the route to safety or to the safety equipment.

Fire identifies equipment which can be used to help extinguish a fire.

Rigid Plastic
400 x 600mm
5 8991

Pipeline Marking

What you need to know

The Health and Safety (Safety Signs and Signals) Regulations 1996 require employers to mark visible pipes in the workplace which contain or transport dangerous substances. BS 1770: 2014 Identification of Pipelines and Services, specifies the colours to be used for the identification of pipes containing or transporting dangerous substances, including conduits for electrical services and ventilation.

Basic Identification Colour Bands

Colour	Pipe Contents	BS4800 Colour Reference
Green	Water	12 D 45 Green
White	Steam	10 A 03 Silver - Grey
Brown	Oil	06 C 39 Brown
Blue	Gases	08 C 35 Yellow Ochre
Purple	Acids & Alkalis	22 C 37 Violet
Light Blue	Air	20 C 51 Light Blue
Black	Other Liquids	00 E 53 Black
Orange	Electrical Services & Ventilation	06 E 51 Orange
Red	Fire Fighting	04 E 52 Red
Yellow	Warning	08 E 51 Yellow
Blue	Fresh Water	18 E 53 Auxiliary Blue

Positioning Markers
All changes of direction. Every 15' (4.5m) on straight pipe runs. Colour band at each side of flow or out position. Colour band at each side of inlet or outlet.

Hazardous Substances
The Health & Safety (Safety Signs and Signals) Regulations 1996 state that pipes containing hazardous substances must be clearly marked with the appropriate symbol. As shown in the Positioning Pipeline Markers diagram, these symbols should be shown on every flow marker.

Rigid Plastic
400 x 600mm
5 8131

Construction Site Safety Checklist

This checklist identifies areas of the hazards most commonly found on construction sites. The questions & sites are intended to help you decide whether your site is a safe and healthy place to work. It is not an exhaustive list. More detailed information can be found in HSE's health and safety construction and other HSE publications.

Safety Checklist for Construction Sites

- Site Management
- Access and Egress
- Excavations
- Foundations
- Structural Work
- Roofing
- Services
- Hoisting
- Plant and Machinery
- Working at Height
- Working in Confined Spaces
- Weather
- Fire and Emergency
- Security
- Welfare
- Provision of Information
- Provision of Training
- General

Rigid Plastic
600 x 900mm
5 8126 * Extra Large

Construction Sites

What you need to know

The regulations come into force on 6 April 2015, consisting of 5 parts:

- Part 1: The interpretation and application of the Regulations.
- Part 2: Chief duties to be met in managing construction projects.
- Part 3: Health & safety duties and roles of the designers and contractors leading to the construction phase plan.
- Part 4: General requirements that apply to all construction sites.
- Part 5: Common for transitional arrangements and revocations.

CON 2015 Improves Health, Safety & Welfare in Construction by helping to:

- Identify and plan the work on the risks involved and managed from start to finish.
- Have the right people for the right job at the right time.
- Coordinate and coordinate your work with others.
- Have the right information about the risks and how they are being managed.
- Communicate this information effectively to those who need to know.
- Consult and engage with workers about the risks and how they are being managed.

A Guide to Part 2: For all Construction Projects, Commercial Clients must:

- Make suitable arrangements for managing their project, enabling those carrying it out to manage Health and Safety risks in a proportionate way.
- Appointing the contractors and designers to the project (including the principal designer and principal contractor on projects involving more than one contractor) while making sure they have the skills, knowledge, experience and organisational capability.
- Allowing sufficient time and resources for each stage of the project.
- Making sure that any principal designer and principal contractor appointed carry out their duties in managing the project.
- Making sure suitable welfare facilities are provided for the duration of the construction work.
- Maintain and review the management arrangements for the duration of the project.
- Provide pre-construction information to every designer and contractor either before or after they are appointed to the project.
- Ensure that the principal contractor or contractor (or single contractor project) prepares a construction phase plan before that phase begins.
- Ensure that the principal designer prepares a health and safety file for the project and that it is available as necessary and made available to anyone who needs it for subsequent work at the site.

Rigid Plastic
400 x 600mm
5 8130

Scaffold Safety

What you need to know

The Work at Height Regulations 2005 require an assessment to be undertaken before starting any work at height. If the assessment confirms that there is no alternative to working at height, then suitable access equipment should be used, taking into account the nature of the work.

Scaffold Construction
Scaffolding should be designed and erected in accordance with the manufacturer's or supplier's Handbook. Any proposed modifications or alterations, such as the addition of bracing, should be designed by a competent person. Inspection of erected scaffolding should be carried out by a competent person. Scaffolding should be clearly signed to indicate when they are not to use.

Safety Checklist

- Have scaffolds been erected, altered and dismantled by competent persons?
- Is there safe access to the scaffold platform?
- Are all uprights provided with suitable bases to prevent slipping or sinking?
- Are all uprights, ledgers, braces and struts securely in position?
- If required, is the scaffold firmly secured to the building?
- Are there adequate and appropriate guard-rails and toe boards in place?
- Are the work platforms fully boarded and arranged to avoid tripping or slipping?
- Are there effective barriers / warning notices in place to prevent people using incomplete / unsafe scaffolding?
- Has the scaffolding been designed and constructed to cope with the load required and is it evenly distributed?
- Do you inspect the scaffolding regularly (once a week), after it has been altered or following extreme weather?

Scaffolding Inspection
Scaffold inspections should be conducted by an appropriately qualified person. Scaffold registers should note defects and corrective actions taken.

Rigid Plastic
400 x 600mm
5 8132

THE ELECTRICITY AT WORK REGULATIONS 1989

Extracts from the Electricity at Work Regulations 1989, SI 1989 No.535, applicable to all work activities and premises except certain mines and quarries, certain offshore installations and certain ships.

GENERAL DUTY
1. It shall be the duty of every employer to ensure, so far as is reasonably practicable, that his employees are not exposed to any risk of injury from electric shock, fire or any other danger arising from the use of electrical systems or equipment in the workplace.

SAFETY
2. Where the employer is required by regulation 3 to take any special measures to protect his employees from any risk of injury from electric shock, fire or any other danger arising from the use of electrical systems or equipment in the workplace, he shall ensure that those measures are taken in accordance with the following provisions.

SAFETY SIGNAGE
3. Where the employer is required by regulation 3 to take any special measures to protect his employees from any risk of injury from electric shock, fire or any other danger arising from the use of electrical systems or equipment in the workplace, he shall ensure that those measures are taken in accordance with the following provisions.

SAFETY SIGNAGE
4. Where the employer is required by regulation 3 to take any special measures to protect his employees from any risk of injury from electric shock, fire or any other danger arising from the use of electrical systems or equipment in the workplace, he shall ensure that those measures are taken in accordance with the following provisions.

Rigid Plastic
400 x 600mm
5 8119

Hand Signalling

The Health and Safety (Safety Sign and Signals) Regulations

Danger
Emergency stop. Both arms point upwards with the palms facing forwards.

Start
Attention, start of movement. Both arms are extended horizontally with the palms facing forwards.

Stop
Interception, end of movement. The right arm points upwards with the palm facing forwards.

End
End of operation. Both hands clasped at chest height.

Raise
The right arm points upwards and slowly makes circles.

Lower
The right arm points downwards and slowly makes circles.

Vertical Distance
The hands indicate the relevant vertical distance.

Move Forward
Both arms are bent with the palms facing upwards and the arms make slow movements towards the body.

Move Backwards
Both arms are bent with the palms facing downwards and arms making slow movements away from the body.

Horizontal Distance
The hands are vertical to each other and indicate the relevant horizontal distance.

Right On the Ground
The right arm is extended horizontally with the palm facing downwards and slowly making movements to the right.

Left On the Ground
The left arm is extended horizontally with the palm facing downwards and slowly making movements to the left.

Rigid Plastic
400 x 600mm
5 8122

KNOW YOUR FIRE EXTINGUISHERS

Water
ABC Powder
Foam Spray
Carbon Dioxide

Water
A ✓ SAFE FOR: Paper, wood, fabric, oil, water.
B ✗ NOT FOR: Flammable liquid fires.
C ✗ NOT FOR: Live electrical equipment.

ABC Powder
A ✓ SAFE FOR: Paper, wood, fabric, oil, water.
B ✓ SAFE FOR: Flammable liquid fires.
C ✓ SAFE FOR: Gaseous fires.

Foam Spray
A ✓ SAFE FOR: Paper, wood, fabric, oil, water.
B ✓ SAFE FOR: Flammable liquid fires.
C ✗ NOT FOR: Live electrical equipment.

Carbon Dioxide
A ✓ SAFE FOR: Paper, wood, fabric, oil, water.
B ✓ SAFE FOR: Flammable liquid fires.
C ✗ NOT FOR: Live electrical equipment.

DO NOT USE
Flammable liquid fires, Live electrical equipment, Paper, wood, fabric, oil, water, Live electrical equipment, Flammable liquid fires, Live electrical equipment.

Synthetic Paper
510 x 760mm
5 9820

GHS Symbols and Hazardous Substances

Know Your GHS and CHIP Warning Symbols

The Globally Harmonized System (GHS) of classification and labeling of chemicals was introduced in 2002 and sets the global standard for the storage and use of hazardous substances. This poster has been designed to help employees identify the potential hazards of chemicals through recognition of the symbols shown below.

Hazard: Explosive GHS Symbol: CHIP Symbol: GHS Hazard Class and Category: Explosives, categories 1, 2, 3 Substances include: Explosives of Division 1.1, 1.2, 1.3, 1.4 Self-reactive substances and solids, Type A.1 Organic peroxides, Type A.1	Hazard: Flammable GHS Symbol: CHIP Symbol: GHS Hazard Class and Category: Flammable gases, category 1 Flammable liquids, categories 1, 2 Flammable solids, category 1 Self-reactive substances and solids, Type 1.1, 1.2 Organic peroxides, category 1 Flammable aerosols, category 1 Flammable dusts, category 1 Flammable powders, category 1	Hazard: Oxidizing GHS Symbol: CHIP Symbol: GHS Hazard Class and Category: Oxidizing gases, category 1 Oxidizing liquids, categories 1, 2, 3
Hazard: Compressed Gas GHS Symbol: CHIP Symbol: GHS Hazard Class and Category: Gases under pressure: - Compressed gases - Liquefied gases - Refrigerated liquefied gases - Dissolved gases	Hazard: Corrosive GHS Symbol: CHIP Symbol: GHS Hazard Class and Category: Corrosion to metal, category 1 Skin corrosion, categories 1A, 1B, 1C Serious eye damage, category 1	Hazard: Toxic GHS Symbol: CHIP Symbol: GHS Hazard Class and Category: Acute toxicity (oral, dermal, inhalation), categories 1, 2, 3
Hazard: Irritant GHS Symbol: CHIP Symbol: GHS Hazard Class and Category: Acute toxicity (oral, dermal, inhalation), category 2 Skin irritation, category 2 Eye irritation, category 2 Specific Target Organ Toxicity - Single exposure, category 2	Hazard: Health Hazard GHS Symbol: CHIP Symbol: GHS Hazard Class and Category: Respiratory sensitization, category 1 Skin sensitization, categories 1A, 1B, 1C Reproductive toxicity, categories 1A, 1B, 1C Specific Target Organ Toxicity - Single exposure, categories 1, 2 Specific Target Organ Toxicity - Repeated exposure, categories 1, 2 Aspiration hazard, category 1	Hazard: Environmental Hazard GHS Symbol: CHIP Symbol: GHS Hazard Class and Category: Hazardous to the aquatic environment - Acute hazard, category 1 - Chronic hazard, categories 1, 2

Rigid Plastic
400 x 600mm
5 8165

Control of Substances Hazardous to Health Regulations 2002 (CoSHH)

Under CoSHH all persons at work need to know the safety precautions to take so as not to endanger themselves or others through exposure to substances hazardous to health.

What you need to know

Employers Must

- Assess health risks to employees and others working on the premises.
- Initiate procedure to control and monitor unavoidable exposure to substances which may harm the health of employees and others on the premises.
- Provide information and training relevant to the hazards associated within each area of working to ensure that all personnel are aware of the risks involved and preventative measures taken to control them.

Employees Must

- Make full and proper use of any control measure, personal protective equipment (PPE) or other facility provided.
- Report any defects found in the control measures, PPE or facilities provided.
- Follow the instructions provided within data sheets or other safety information and only use and dispose of substances in the recommended manner.

Get to know the warning symbols

OXIDIZING	CORROSIVE	TOXIC	IRRITANT	ENVIRONMENTAL HAZARD
EXPLOSIVE	FLAMMABLE	COMPRESSED GAS	HEALTH HAZARD	

Rigid Plastic
400 x 600mm
5 8117

Handling Chemicals Safely

- All chemicals should be clearly marked.
- Be aware of the storage requirements of each type.
- Take extreme care when mixing chemicals.
- Keep away from heat and flames.
- Avoid oral contact of any kind.
- Never inhale.
- Avoid contact with skin and eyes.

Chemical Checklist

- Read and understand the label before opening any container.
- Double-check that the chemical you are opening is the one required.
- Consider the hazards, including violent reactions between chemicals.
- Open container carefully in a well ventilated area.
- Always wear appropriate protective clothing.
- Take extreme care whilst using hazardous chemicals.
- Use method which reduces risk of inhalation, ingestion or contact with skin, eyes and clothing.
- Never eat, drink or smoke whilst handling chemicals.
- Always seal container tightly after use.

Know your CoSHH and GHS Warning Symbols

Explosive - May explode or fragment to hot, high velocity shrapnel. - Avoid system rupture (leaks, spills, fires). - Keep your distance. - Wear protective clothing.	Health Hazard - May cause serious and prolonged health effects on short or long term exposure. - Do not breathe the vapour, allow it to come into contact with skin or breathe it. - Inhalation, ingestion and skin contact should be avoided. - Wear protective clothing.
Oxidizing - Causes oxygen enriched atmosphere to increase rapidly, thereby increasing the fire or explosion hazard. - Avoid system rupture (leaks, spills, fires). - Keep your distance. - Wear protective clothing.	Irritant - May cause irritation to the skin, eyes and respiratory tract. - Avoid contact with skin and eyes. - Do not breathe vapour or smoke. - Do not touch contaminated surfaces.
Flammable - Flammable if exposed to ignition sources, sparks, heat. Some substances will self-ignite at room temperature. - Avoid contact with skin and eyes. - Do not breathe vapour or smoke. - Keep your distance. - Wear protective clothing.	Corrosive - Causes severe damage which may lead to skin burns and permanent eye damage. - Avoid contact with skin and eyes. - Do not breathe vapour or smoke. - Do not touch contaminated surfaces.
Compressed Gas - Corrosive gas under pressure. (See relevant hazard labels). - Do not touch containers. - Avoid contact with skin and eyes.	Environmental Hazard - Toxic to aquatic organisms and may cause long lasting effects in the environment. - Avoid release to the environment.

Rigid Plastic
400 x 600mm
5 8136

D.S.E.A.R Dangerous Substances and Explosive Atmosphere Regulations

The Dangerous Substances and Explosive Atmosphere Regulations (D.S.E.A.R) were introduced in 2002 to set a minimum requirement for the protection of workers from explosion and fire risks relating to dangerous substances and / or potentially explosive atmospheres.

The Regulations implement two European Directives:
 Explosive Atmospheres Directive 99/92/EC (ATEX 137)
 The safety aspects of the Chemical Agents Directive (CAD)

Employers must undertake the following to comply with the DSEAR:

- Conduct a risk assessment of all operations involving dangerous substances.
- Take actions to reduce or eliminate risks.
- Carry out a hazardous area classification.
- Within hazardous zones ensure correctly rated electrical and mechanical equipment is used.
- Make arrangements to deal with accidents and emergencies.
- Provide information and training to employees on DSEAR.
- Identify pipes and containers containing dangerous substances.
- Protect against explosions where a workplace is shared by more than one employer.

Dangerous Substances include:

- Petrol
- Paints
- Varnishes
- Liquefied Petroleum Gas (LPG)
- Combustibles and explosive dust

Rigid Plastic
400 x 600mm
5 8128

Recommended Segregation for Storage of Hazardous Substances

Where a particular material has the properties of more than one class, the classification giving the more onerous segregation should be given.

CLASS	1	2	3	4	5	6	7	8	9
Compressed Gases									
2.1 Flammable	Segregate from	KEEP APART	Segregate from	Segregate from	Segregate from	Segregate from	ISOLATE	KEEP APART	KEEP APART
2.2 Non-flammable/non-toxic	KEEP APART	KEEP APART	KEEP APART	Segregation may not be necessary	Segregation may not be necessary	Segregation may not be necessary	Segregation may not be necessary	Segregation may not be necessary	KEEP APART
2.3 Toxic	Segregation may not be necessary	KEEP APART	Segregation may not be necessary	KEEP APART	KEEP APART	KEEP APART	Segregation may not be necessary	Segregation may not be necessary	KEEP APART
Flammable Liquids									
4.1 Flammable	Segregation may not be necessary	KEEP APART	Segregation may not be necessary	KEEP APART	Segregation may not be necessary	Segregation may not be necessary	Segregation may not be necessary	ISOLATE	KEEP APART
4.2 Spontaneously combustible	Segregation may not be necessary	Segregation may not be necessary	Segregation may not be necessary	KEEP APART	KEEP APART	KEEP APART	ISOLATE	KEEP APART	KEEP APART
4.3 Dangerous when wet	Segregation may not be necessary	KEEP APART	Segregation may not be necessary	KEEP APART	KEEP APART	KEEP APART	KEEP APART	KEEP APART	Segregation may not be necessary
Oxidizing Substances									
5.1 Oxidizing Substances	Segregation may not be necessary	Segregation may not be necessary	Segregation may not be necessary	Segregation may not be necessary	Segregation may not be necessary	KEEP APART	Segregation may not be necessary	Segregation may not be necessary	KEEP APART
5.2 Organic peroxides	ISOLATE	Segregation may not be necessary	Segregation may not be necessary	ISOLATE	Segregation may not be necessary	Segregation may not be necessary	Segregation may not be necessary	Segregation may not be necessary	KEEP APART
Toxic Substances									
6.1 Acute toxicity (oral)	KEEP APART	Segregation may not be necessary	Segregation may not be necessary	KEEP APART	KEEP APART	KEEP APART	KEEP APART	KEEP APART	Segregation may not be necessary
6.2 Acute toxicity (dermal)	KEEP APART	KEEP APART	KEEP APART	KEEP APART	KEEP APART	KEEP APART	KEEP APART	KEEP APART	KEEP APART
6.3 Acute toxicity (inhalation)	KEEP APART	KEEP APART	KEEP APART	KEEP APART	KEEP APART	KEEP APART	KEEP APART	KEEP APART	KEEP APART
6.4 Chronic toxicity (oral)	KEEP APART	KEEP APART	KEEP APART	KEEP APART	KEEP APART	KEEP APART	KEEP APART	KEEP APART	KEEP APART
6.5 Chronic toxicity (dermal)	KEEP APART	KEEP APART	KEEP APART	KEEP APART	KEEP APART	KEEP APART	KEEP APART	KEEP APART	KEEP APART
6.6 Chronic toxicity (inhalation)	KEEP APART	KEEP APART	KEEP APART	KEEP APART	KEEP APART	KEEP APART	KEEP APART	KEEP APART	KEEP APART
6.7 Carcinogenic	KEEP APART	KEEP APART	KEEP APART	KEEP APART	KEEP APART	KEEP APART	KEEP APART	KEEP APART	KEEP APART
6.8 Mutagenic	KEEP APART	KEEP APART	KEEP APART	KEEP APART	KEEP APART	KEEP APART	KEEP APART	KEEP APART	KEEP APART
6.9 Reproductive toxicity	KEEP APART	KEEP APART	KEEP APART	KEEP APART	KEEP APART	KEEP APART	KEEP APART	KEEP APART	KEEP APART
6.10 Aspiration hazard	KEEP APART	KEEP APART	KEEP APART	KEEP APART	KEEP APART	KEEP APART	KEEP APART	KEEP APART	KEEP APART

Rigid Plastic
900 x 600mm
5 8176

* Extra Large

Abrasive Wheel Regulations

ABRASIVE WHEEL SAFETY

MAXIMUM OPERATING SPEEDS

Never exceed the maximum operating speed marked on the wheel or label. Operating a wheel above its maximum speed can be dangerous.

The table below shows the maximum operating speed in rpm of the abrasive wheel or machine spindle for a given abrasive wheel diameter and peripheral operating speed in m/s

Wheel Diameter (mm)	Maximum operating speed in m/s									
	14	16	18	20	22	24	26	28	30	32
100	1400	1200	1000	800	600	400	300	200	150	100
150	1050	900	750	600	450	300	225	150	112	75
200	787	675	562	450	337	225	169	112	84	56
250	630	540	450	360	270	180	135	90	67	45
300	525	450	375	300	225	150	112	75	56	37
350	450	375	300	225	150	112	84	56	42	30
400	390	315	240	180	135	90	67	45	34	24
450	345	270	202	151	113	75	56	37	30	21
500	300	225	169	127	95	63	47	31	26	18
550	262	199	151	113	85	56	42	28	23	16
600	230	173	131	99	74	50	37	25	20	14
650	202	151	113	85	63	45	34	23	18	12
700	179	135	99	74	56	42	30	20	16	11
750	160	120	90	67	50	37	26	18	14	10
800	144	108	81	60	45	34	23	16	12	9
850	131	99	74	56	42	30	20	14	11	8
900	120	90	67	50	37	26	18	12	10	7
950	111	83	63	47	34	23	16	11	9	6
1000	103	77	59	44	33	22	15	10	8	5

For wheels less than 100mm diameter, it is not always possible to mark the maximum operating speed on the product itself. In these cases, this poster should be displayed in the work area.

DON'T FORGET
To ensure the highest level of safety, ensure products are manufactured and marked in accordance with BS EN12413, BS EN13236 or BS EN13743.

Rigid Plastic
400 x 600mm
5 8123

ABRASIVE WHEEL SAFETY

USE OF EQUIPMENT

THE ABRASIVE WHEEL REGULATIONS 1970 HAVE BEEN REPLACED BY THE PROVISION AND USE OF WORK EQUIPMENT REGULATIONS 1998 (PUWER), PLACING A GREATER EMPHASIS ON THE NEED FOR TRAINING AND WIDENING THE SCOPE OF THOSE WHO NEED TO BE TRAINED.

The PUWER 98 Regulations define the responsibilities of the employer to provide suitable equipment, systems of work and training to ensure a safe working environment. It also becomes the responsibility of those operating the equipment to ensure that safe procedures are followed at all times.

All people involved in the use of grinding equipment must:

- Be appointed, trained and considered competent by their employer to use the grinding equipment. Never allow unauthorised people to use their machine.
- Only use grinding machines and abrasive wheels for the purpose for which they are intended and for which they are suitable.
- Examine all wheels for damage or defects before mounting.
- Never use a machine that is not in good working order or one with defective parts.
- Observe all health and safety procedures and written instructions for the use of that equipment.
- Fully understand the equipment's controls, refer to equipment user manual if necessary.
- Be aware of the likely hazards encountered when operating grinding equipment and the relevant procedures in place to prevent accidents.
- Wear appropriate personal protective equipment at all times. Be aware that work pieces and equipment can become very hot.
- Never remove or modify guarding fitted to the machine.
- Follow the correct handling, storage and mounting procedures for abrasive wheels.
- Prevent accidental start-up of the wheel spindle before mounting or changing a wheel. Isolate all machines from their power source when necessary.
- Ensure that clamping devices and work rests are secure and properly adjusted so that the work piece is stable before use.
- Ensure adequate lighting is supplied for the operations being carried out.
- Ensure that all machine and wheel safety markings and warnings are clearly visible. Never mount a wheel that cannot be fully identified or use a machine which does not indicate its spindle speed.
- Never exceed the specified maximum operating speed marked on the wheel.
- Stop wheel rotation before leaving the machine. Never leave the wheel to run on an unattended machine.
- Report all accidents, including wheel breakage.

DON'T FORGET
To ensure the highest level of safety, ensure products are manufactured and marked in accordance with BS EN12413, BS EN13236 or BS EN13743.

Rigid Plastic
400 x 600mm
5 8125

ABRASIVE WHEEL SAFETY

THE ABRASIVE WHEEL REGULATIONS 1970 HAVE BEEN REPLACED BY THE PROVISION AND USE OF WORK EQUIPMENT REGULATIONS 1998 (PUWER), PLACING A GREATER EMPHASIS ON THE NEED FOR TRAINING AND WIDENING THE SCOPE OF THOSE WHO NEED TO BE TRAINED.

Grinding wheels are safe if used correctly - DO

- Read and understand the supplier's safety instructions.
- Ensure that the wheel is suitable for its intended use.
- Handle and store wheels with care.
- Visually inspect and ring all wheels for possible damage before mounting.
- Check mounting flanges for equal and correct diameter and that they are clean, free from burrs and recessed where applicable.
- Use mounting blotters when required.
- Ensure that work rests are properly adjusted and not more than 3mm away from the periphery of the wheel.
- Always use a correctly designed and adjusted wheel guard.
- Wear appropriate PPE (consider eye, ear and hand protection).
- Conduct a trial run at operating speed with guard in place for at least one minute, standing clear of the machine before use.
- Turn off coolant before stopping the wheel to avoid creating an out of balance condition.
- Dress frequently to remove wear and to ensure that the wheel is cutting cleanly.

Grinding wheels are dangerous if abused - DO NOT

- Allow untrained people to mount or use abrasive wheels.
- Use a wheel that has been dropped or damaged in any way.
- Force a wheel to fit on the mounting device or modify the size of the mounting hole.
- Exceed the maximum operating speed marked on the wheel.
- Apply shock or excessive force to the wheel.
- Use mounting flanges which are not clean and flat.
- Tighten the mounting nuts excessively.
- Trap the work piece between the wheel and the work rest.
- Start the machine until the wheel guard is in place and securely fastened.
- Grind on the side of a wheel which is not designed for this operation.
- Stand directly in front of a grinding wheel whenever a machine is started.
- Grind material for which the wheel is not designed.
- Stop the wheel by applying pressure to its surface, let it stop naturally.

DON'T FORGET
To ensure the highest level of safety, ensure products are manufactured and marked in accordance with BS EN12413, BS EN13236 or BS EN13743.

Rigid Plastic
400 x 600mm
5 8124

Work Safety Posters 400 x 600mm - Rigid Plastic

PPE at Work Regulations 1992 (Personal Protective Equipment)

In situations where risks cannot be controlled by other means such as engineering controls or safe systems of work, employers are required to protect their employees from risks to health and safety by providing suitable personal protective equipment.

What you need to know

What an employer must do

1. Provide suitable protective equipment free of charge
2. Maintain PPE in working order and in good condition
3. Provide relevant training in the use of PPE
4. Consult with employees on the suitability of the PPE to be provided

What an employee must do

1. Use the PPE provided
2. Report any defects, damages or lost PPE
3. Take care to correctly store PPE when not in use

PPE must

1. Be relevant to the work being undertaken
2. Protect effectively against the particular risks involved
3. Comply with relevant standards
4. Fit the user properly and comfortably and adjust where necessary
5. Not hinder the performance of the task or add to the risks involved

5 8113

The Control of Noise at Work Regulations 2005

Controlling Noise

What you need to know

Inevitable damage to hearing can be caused by exposure to high noise levels. The Control of Noise at Work Regulations 2005 place duties on employers and employees to reduce the risk of damage to hearing at work. Ensure you are familiar with the categories of low and the actions to be taken.

Employers Must

Reduce the risk of hearing damage to the lowest levels reasonably practicable.

Ensure noise assessments are carried out by a competent person.

Ensure a record of assessments are kept until re-assessment.

Use means other than ear defenders to reduce exposure to noise.

Provide necessary training, instruction and information on risks to hearing and how to minimise them and how to obtain ear protection when required.

So far as reasonably practicable place warning signs in ear protection areas.

Provide hearing checks where noise assessments indicate a risk of hearing loss.

Ensure ear protection is:

- a) Provided to employees who ask for them
- b) Provided to all those who are exposed
- c) As used by those exposed
- d) Are kept and maintained to a satisfactory standard

Ensure ear protection is used by all those who enter ear protection areas.

Low Noise	No Action Level	High Noise
✓	✓	✓
✓	✓	✓
✓	✓	✓
✓	✓	✓
✓	✓	✓
✓	✓	✓
✓	✓	✓
✓	✓	✓
✓	✓	✓

Employees Must

Use the ear protection provided.

Use all other protective equipment provided.

Report any faults or defects found with the ear protection or equipment.

5 8116

Manual Handling Operations Regulations 1992

Under these regulations additional duties are placed on employers to avoid hazardous manual handling operations and take steps to reduce the risk of injury from such operations so far as is reasonably practicable.

8 Steps to Safer Manual Handling:

- 1. Check the Load**
Ensure you know what you are trying to lift and where it is to be carried to. What does it weigh? Is it an awkward shape? Will it become a task?
- 2. Personal Limitations**
Know the limit of your own ability. Consider your age, strength, stress or grip. It does not require a great deal of weight to cause injury through manual handling. If in doubt, get help.
- 3. Get a Proper Grip**
Make sure you have a good hand hold. Grip with the palms of the hands and the ends of the fingers. Never lift with the finger tip!
- 4. Stance**
Face the direction of travel if you are lifting alone. Stand over the object with feet shoulder width apart and one foot a little in front of the other. Bend at the knees.
- 5. Keep Arms Close to Body**
Keep the arms close to the body. This ensures that the legs and body take the weight instead of the hands and arms.
- 6. Keep the Chin in**
Before lifting, raise the head slightly and tuck the chin in. This helps to keep the back straight.
- 7. Body Weight**
Be aware of your body weight and how to use it to the best advantage. Use your body as a counterweight to save muscular effort.
- 8. Co-ordinate effort**
Where two or more people are involved in the lift make sure the handling is co-ordinated correctly. Communication and team work are key.

5 8114

The Work at Height Regulations 2005

The Work at Height Regulations 2005 are applicable to work of any kind at height, where there is a risk of a fall that may cause personal injury.

What an employee must do

1. Report any potential or existing safety hazard to employer
2. Follow any training and instructions provided by employer (unless the employee deems it to be unsafe, in which instance any concerns should be reported back before undertaking work)
3. Use the appropriate equipment provided

What an employer must do

1. Must undertake any and all reasonably practicable steps to prevent falling
2. Follow the Regulations simple hierarchy for managing and selecting equipment for work at height

Duty holders are required to

1. Avoid carrying out work at height wherever possible and reasonable
2. Where working at height cannot be prevented, use work equipment or undertake other steps to prevent falls
3. Where a risk of a fall cannot be eliminated, use work equipment or other appropriate measures to reduce the height and consequences of a potential fall

Regulations equipment on duty holders

1. Ensure all work at height is properly planned and organised, taking account of weather conditions that could endanger the safety of personnel
2. Provide adequate training to ensure those working at height are competent to undertake work
3. Ensure place and height of work is safe
4. Appropriately inspect all equipment provided for work at height
5. Properly control the risks from fragile surfaces
6. Control the risks from falling objects

5 8129

Mineral Oil

What you need to know

Mineral Oil is harmful if swallowed or inhaled and can cause irritation to skin, eyes and respiratory tract.

Incident	Effect	First Aid Procedure
Ingestion	Mineral Oil is a lubricant, its effects may result in serious abdominal cramping, nausea, diarrhoea or vomiting. Aspiration into the lungs can also cause chemical pneumonitis.	Do not induce vomiting if mineral oil is swallowed. Only if conscious, give large quantities of water (never give anything by mouth for an unconscious person). Get medical attention without delay.
Inhalation	Can cause irritation to the respiratory tract. Symptoms include sore throat, coughing. Aspiration pneumonia may result from food or vapour product.	Get affected persons to fresh air and get medical attention where appropriate. Provide oxygen to those with difficulty breathing and artificial respiration to those not breathing.
Contact with Eyes	Eyes irritation and discomfort similar to that caused by motor oil may result from mists or fumes.	Continuously flush eyes immediately with plenty of water for at least 15 minutes, good best, lifting lower and upper eyelids on occasion. Medical attention should be given immediately.
Contact with Skin	Extended contact may cause irritation and possibly dermatitis due to hypersensitivity.	Wash skin immediately and over a sustained 15 minute period with plenty of water. Contaminated clothing and shoes should be removed and medical attention arranged. Wash/soak any affected clothing or shoes before reuse.

Chronic Exposure

Repeated or prolonged skin exposure may cause dermatitis. Irritated and mildly treated skin are listed by both ILO and OSHA as human carcinogens (pink, lightly red, irritated skin are not classified in this way).

Apparatus of Pre-existing Conditions

Those with pre-existing skin disorders or impaired respiratory function could be more susceptible to mineral oil.

Handling and Storage

1. Mineral Oil should be kept in a tightly closed container and stored in a cool, dry, well-ventilated area away from sources of heat or ignition.
2. Store mineral oil away from combustible or reactive materials and in an area protected against physical damage and away from direct sunlight.
3. Containers used for this material may be hazardous even when empty as they retain vapour and liquid residues.
4. Warnings and precautions listed for any mineral oil product should be observed and where appropriate acted on.

5 8127

Provision and Use of Work Equipment Regulations 1998

Any equipment which is used by a number of staff at work is covered by PUWER. If you allow employees to provide their own equipment, it too will be covered by PUWER and you will need to ensure it complies.

These regulations require risks to people's health and safety, from equipment that they use at work, to be prevented or controlled.

General Provisions

In general terms, the regulations require that equipment provided is:

- Suitable for intended use
- Safe for use, maintained in a safe condition and in certain cases, inspected to ensure it remains safe.
- Accompanied by suitable safety measures, e.g. protective devices, markings and warnings.
- Used by people who have received adequate information, instruction and training.

Main Provisions

Employers must ensure that:

- Measures are in place to minimise risks.
- Only fully trained personnel are allowed to use equipment where there is a specific risk.
- Work equipment provided is suitable, maintained and used without risk.

Employees:

Do not have duties under PUWER, but do have general duties under the Health and Safety at Work Act and the Management of Health and Safety at Work Regulations 1999, for example to take reasonable care of themselves and others who may be affected by their actions.

5 8990

Slips & Trips - The Statistics

Slips, Trips & Falls

Are you reducing the risks?

Slips and trips are the most common cause of injuries in UK workplaces. They are the cause of almost 11,000 (30%) of all major injuries each year.

Slips, Trips and Falls occur in almost all workplaces and 95% of slips occur on indoor floors with one out of five of all major accidents such as falls from heights. Every floor surface in a workplace can be so in reasonably practicable that be kept free from obstructions and from any liquids or substances which may cause a person to slip, trip or fall. Any hole in a floor in a public area must be effectively guarded with barriers and its presence should be indicated by appropriate signs.

Lighting

Lighting should be adequate to ensure people can clearly see obstructions or other potential hazards. Any areas of poor or faulty lighting must be reported. Fixed or replace as soon as possible, to ensure high levels of safety.

Spillages

Once a spill has been identified ensure it is cleaned up promptly using the appropriate cleaning agent and method. If the floor remains wet, ensure people are aware of this by displaying the hazard using appropriate signs or floor stands, until the floor is dry.

Footwear

If specific footwear is required for safety reasons e.g. high-risk environments, employers must provide them.

Snow and Ice

Any areas susceptible to snow and ice should be treated with salt or grit and any relevant signage erected.

Cables

Uncovered cables should never cross walkways or be across a potential trip hazard. Cable protectors and ties should be used to prevent trips where necessary.

Floors

Identify any holes or cracks that may cause a hazard. These should be identified to employees and repaired as soon as possible. Floors susceptible to becoming slippery should be treated with an anti-slip floor coating or matting. Decrease the risk of slipping on stairs by using anti-slip treads and mats.

Obstructions

Ensure work areas are kept clear. Slip and trip free environments at all times. This applies to signs or stands when obstructions cannot be removed.

5 8219

Battery Charging Safety Procedures

The following relates to lead-acid industrial batteries that are used in the following applications: To power forklift trucks and other vehicles or to provide backup for equipment in the event of a mains failure.

Chemical Safe Working Practices

Protective clothing such as face masks, goggles and gloves must be worn.

Ensure staff are aware of and provided with appropriate and/or direct facilities.

Spillage handling equipment and procedures should be in place.

Staff should be aware of procedures relating to working with spillages.

Electrical Safe Working Practices

Ensure charger is switched off before the battery is connected / disconnected.

No tools or other conductive objects should be placed on top of battery.

Remove any metallic items like jewellery from hands, wrists, neck etc.

Always disconnect the earthed terminal first and reconnect it last.

Ensure staff are made aware of the actions to undertake in the event of electric shock taking place.

Always use insulated tools.

Explosion Safe Working Practices

Ensure there is good ventilation at a high level above the batteries.

Charging area should be clearly marked "No Smoking" and "No Naked Lights".

Make sure the battery is topped up to correct level.

Ensure all connections are secure before switching on.

Electrical equipment/sockets of ignition should be kept away from charger.

Keep batteries upright and properly secured during charging.

Use the lifting hoists provided on the battery container.

Wear essential protective clothing and footwear at all times.

5 8135

Electricity on Site Health & Safety Guidance

Guidance for employees working on sites containing live cables and overhead wires.

BE AWARE Not all cables will be clearly marked on plans

For safety always assume all houses, offices, factories and shops have live cables running into them, no matter what your plans show.

Take time to trace the cables and mark them against the plans provided.

Scan the area with a detector to make sure the area is safe before excavating it.

Initially make only trial holes to locate cables before using a mechanical digger.

If any cables are damaged control off the area and immediately call the local electricity supplier.

NEVER ASSUME Check an area is safe before starting work

Always be aware that live cables can be anywhere, at any depth, even just below the surface.

Never assume a disused or derelict building has no live cables.

Take care, even when only using hand tools.

REMEMBER Check for Overhead Lines

Always look up when operating any kind of machinery particularly if it goes above head height.

Never drive with a wagon's upper raised anywhere within the area.

Take care when erecting scaffolding or hoisting.

Always be aware of overhead cables when falling trees.

Never tip landfill under overhead wires.

5 8134

Need a bespoke poster?
We can print any design on a range of different materials. **Contact us for a quote**

Our range of eye-catching safety posters are a perfect solution to businesses wanting to display specific health and safety guidance / advice to a wider audience. We always recommend the regular rotation of posters to keep your displays fresh and interesting to staff, increasing the potential for posters being read. You will find a range of frame options on page 52 to help protect and further highlight the poster on display.

Good to Go Safety Posters

420 x 594mm - These posters are printed on an eco-friendly, PVC-free synthetic paper that has excellent tear and water resistance properties.



GET TO KNOW YOUR LADDERS
CARRY OUT PRE-USE CHECKS

- 1
- 2
- 3
- 4
- 5
- 6
- 7
- 8
- 9

Need more inspection checklists? www.goodtosafety.co.uk

5 1361

GET TO KNOW YOUR MEWP
CARRY OUT PRE-USE CHECKS

- 1
- 2
- 3
- 4
- 5
- 6
- 7
- 8
- 9
- 10
- 11
- 12
- 13
- 14
- 15
- 16
- 17
- 18

Need more inspection checklists? www.goodtosafety.co.uk

5 1366

GET TO KNOW YOUR PALLET TRUCKS
CARRY OUT PRE-USE CHECKS

- 1
- 2
- 3
- 4
- 5
- 6
- 7

Additional Checks for Electric Powered Pallet Trucks

- 8
- 9
- 10
- 11
- 12
- 13
- 14
- 15

Need more inspection checklists? www.goodtosafety.co.uk

5 1364

GET TO KNOW YOUR FORKLIBTS
CARRY OUT PRE-USE CHECKS

- 1
- 2
- 3
- 4
- 5
- 6
- 7
- 8
- 9
- 10
- 11
- 12
- 13
- 14
- 15
- 16
- 17

Need more inspection checklists? www.goodtosafety.co.uk

5 1360

GET TO KNOW YOUR TRACTOR
CARRY OUT PRE-USE CHECKS

Engine

- 1
- 2
- 3
- 4
- 5
- 6

Exterior

- 7
- 8
- 9
- 10
- 11
- 12

Inside the Cab

- 13
- 14
- 15
- 16

Need more inspection checklists? www.goodtosafety.co.uk

5 1386

GET TO KNOW YOUR TRAILERS
CARRY OUT PRE-USE CHECKS

- 1
- 2
- 3
- 4
- 5
- 6
- 7
- 8
- 9
- 10
- 11
- 12
- 13
- 14
- 15
- 16
- 17
- 18
- 19
- 20

Need more inspection checklists? www.goodtosafety.co.uk

5 1365

GET TO KNOW YOUR LOADER CRANE
CARRY OUT PRE-USE CHECKS

- 1
- 2
- 3
- 4
- 5
- 6
- 7
- 8
- 9
- 10
- 11
- 12
- 13
- 14
- 15
- 16
- 17
- 18
- 19

Need more inspection checklists? www.goodtosafety.co.uk

5 1367

GET TO KNOW YOUR EXCAVATOR
CARRY OUT PRE-USE CHECKS

Cab Compartment

- 1
- 2
- 3
- 4

Engine Compartment

- 5
- 6
- 7
- 8

Exterior

- 9
- 10
- 11
- 12
- 13
- 14

Need more inspection checklists? www.goodtosafety.co.uk

5 1369

GET TO KNOW YOUR VEHICLES
CARRY OUT PRE-USE CHECKS

Engine Compartment

- 1
- 2
- 3
- 4
- 5
- 6

General Condition

- 7
- 8
- 9
- 10
- 11
- 12

Accessibility

- 13
- 14

Need more inspection checklists? www.goodtosafety.co.uk

5 1387

GET TO KNOW YOUR SCAFFOLDING
CARRY OUT PRE-USE CHECKS

- 1
- 2
- 3
- 4
- 5
- 6
- 7
- 8
- 9
- 10
- 11
- 12
- 13
- 14
- 15
- 16

Need more inspection checklists? www.goodtosafety.co.uk

5 1388

GET TO KNOW YOUR TOWER
CARRY OUT PRE-USE CHECKS

- 1
- 2
- 3
- 4
- 5
- 6
- 7
- 8
- 9
- 10
- 11
- 12
- 13
- 14

Need more inspection checklists? www.goodtosafety.co.uk

5 1363

GET TO KNOW YOUR HARNESS
CARRY OUT PRE-USE CHECKS

- 1
- 2
- 3

Webbing

- 4
- 5
- 6
- 7
- 8

Hardware

- 9
- 10
- 11
- 12

Need more inspection checklists? www.goodtosafety.co.uk

5 1368

GET TO KNOW YOUR PODIUM STEPS
CARRY OUT PRE-USE CHECKS

- 1
- 2
- 3
- 4
- 5
- 6
- 7
- 8
- 9
- 10
- 11
- 12
- 13

Need more inspection checklists? www.goodtosafety.co.uk

5 1389

GET TO KNOW YOUR FORKLIBT'S WORK PLATFORM
CARRY OUT PRE-USE CHECKS

- 1
- 2
- 3
- 4
- 5
- 6
- 7
- 8
- 9
- 10
- 11
- 12

Need more inspection checklists? www.goodtosafety.co.uk

5 1390

GET TO KNOW YOUR OVERHEAD CRANE
CARRY OUT PRE-USE CHECKS

- 1
- 2
- 3
- 4
- 5
- 6
- 7
- 8
- 9
- 10
- 11
- 12
- 13
- 14
- 15

Need more inspection checklists? www.goodtosafety.co.uk

5 1391

GET TO KNOW YOUR RACKING
CARRY OUT PRE-USE CHECKS

Location

- 1
- 2
- 3

Structure

- 4
- 5
- 6
- 7
- 8

Loading

- 9
- 10

Need more inspection checklists? www.goodtosafety.co.uk

5 1362

Caricature Safety Posters

510 x 760mm - These posters are printed on an eco-friendly, PVC-free synthetic paper that has excellent tear and water resistance properties.



5 8188

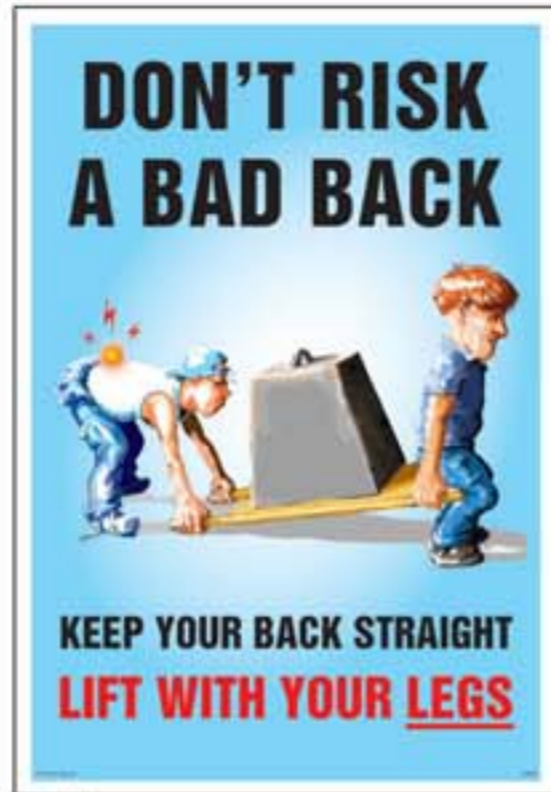

5 8181

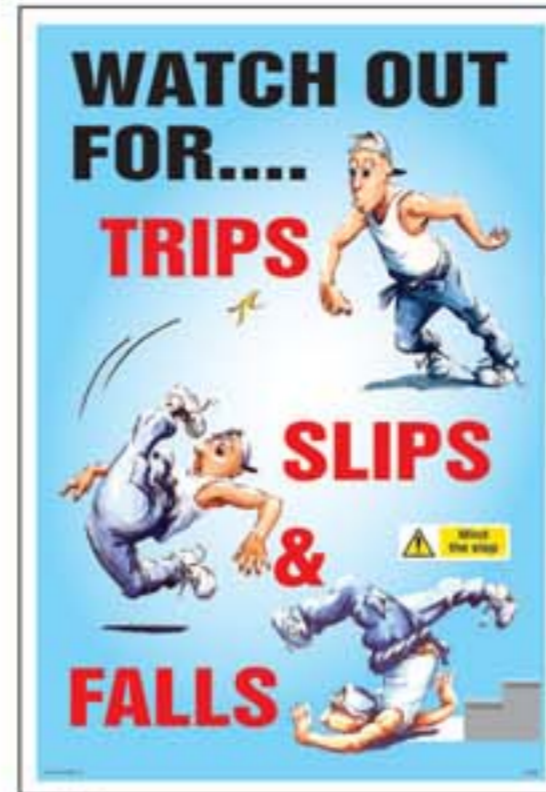

5 8182



5 8183



5 8189

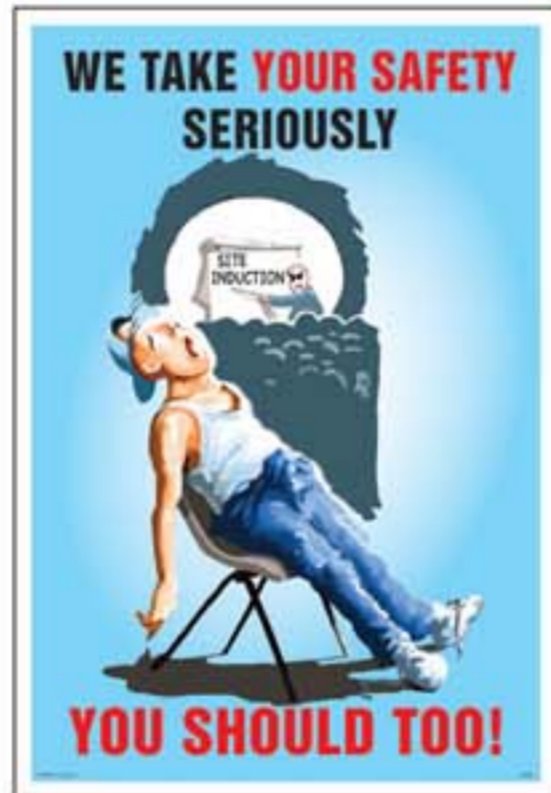

5 8186

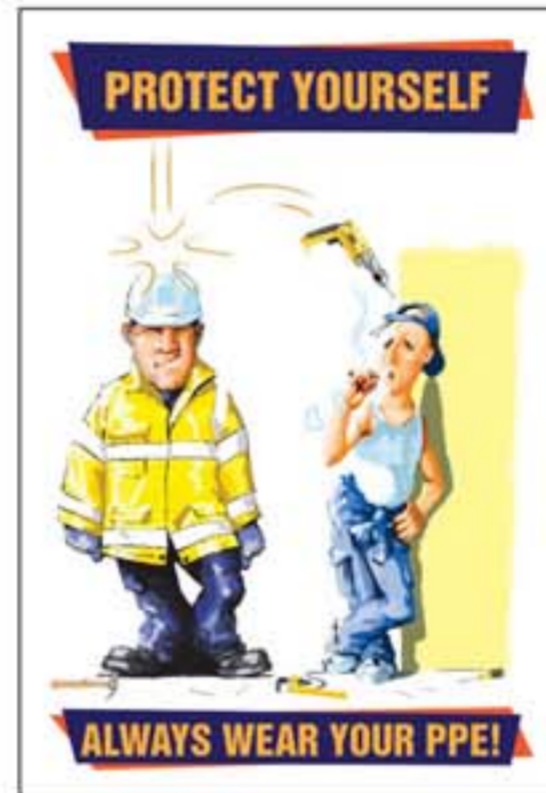

5 9821



5 8184

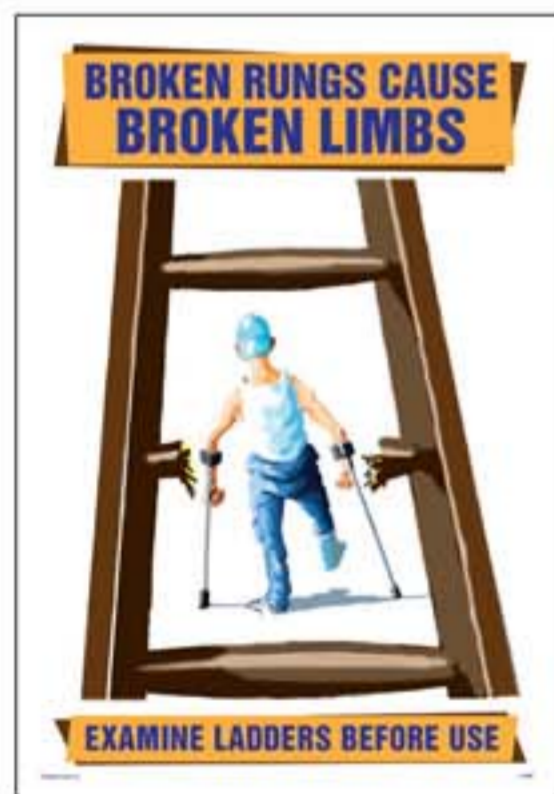

5 8190

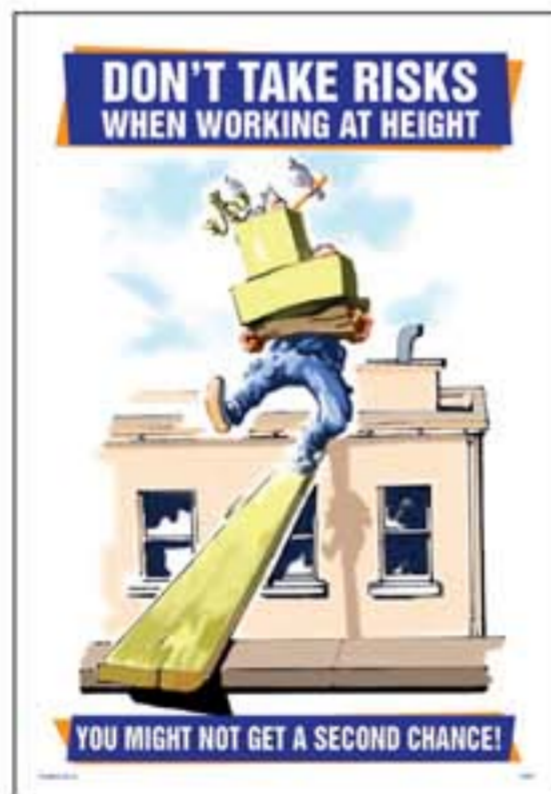

5 8191



5 9822



5 8185

Aluminium Snap Frame

Snap frames allow easy insert and removal of posters allowing frequent update of information and safety messages.

Remove the unsightly look of pinned or taped posters to walls. Make the same posters look important and professional by using Aluminium Snap Frames.

More options available on page 52.

- 25mm extruded aluminium frame
- 1.5mm strong plastic back panel
- Anti-glare poster cover
- Durable protective frame finish

510 x 760mm
5 9815

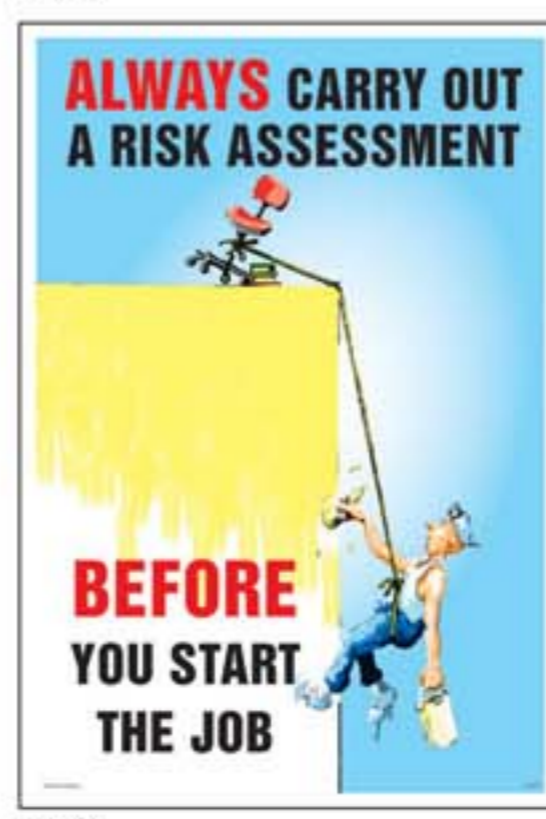

5 8187



5 8180

PPE Safety Posters

420 x 594mm - These posters are printed on an eco-friendly, PVC-free synthetic paper that has excellent tear and water resistance properties.



5 7473



5 7475



5 7476



5 7474

PPE Signs
For a full range of personal protective equipment (PPE) and mandatory signage see pages 36 - 38.
If you can't find the message or design you require, please ask for a quote



5 7477



5 7479



5 7478

Safety Quote Posters 420 x 594mm - These posters are printed on an eco-friendly, PVC-free synthetic paper that has excellent tear and water resistance properties.



5 7462



5 7467



5 7464



5 7466



5 7468



5 7463



5 7465



5 7469

Office and GDPR Posters



Synthetic Paper
420 x 594mm
5 5636

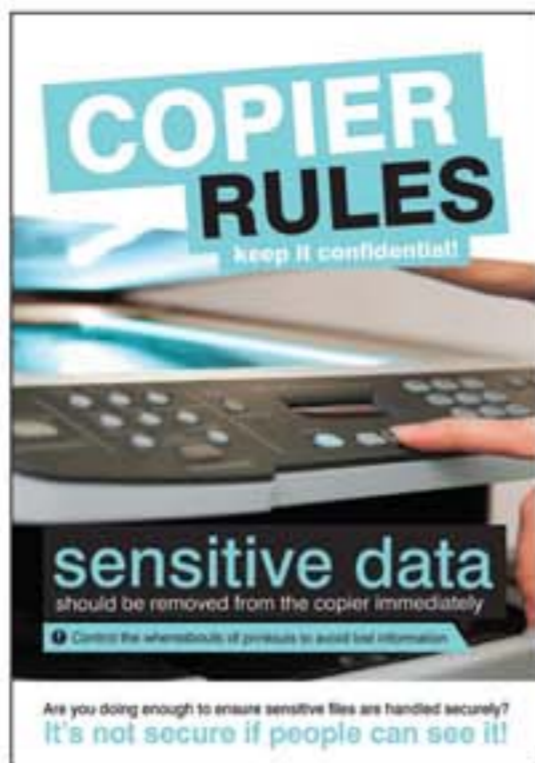

Synthetic Paper
420 x 594mm
5 5638

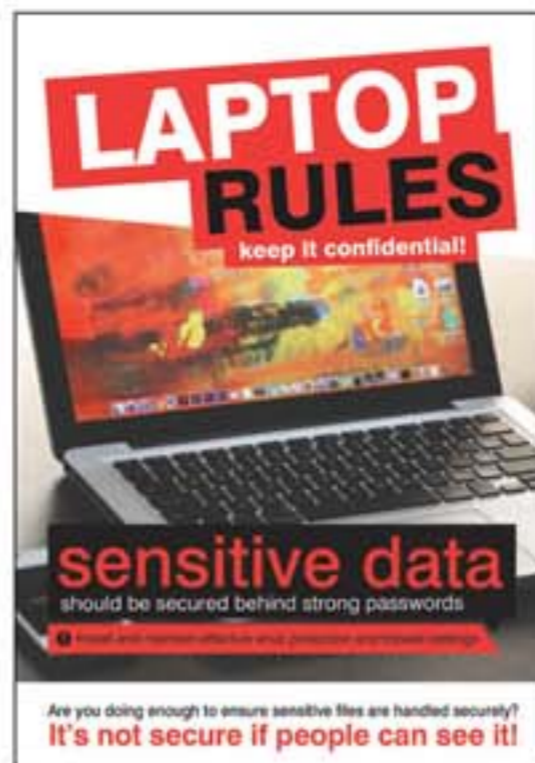

Synthetic Paper
420 x 594mm
5 5637



Synthetic Paper
420 x 594mm
5 5635

Easy Snap Frames

These frames are finished in four attractive colours and supplied with an anti-glare protective cover. They enable easy insert and removal of posters allowing frequent updates of information. These durable extruded aluminium snap frames are built to last.

- 25mm Frame • Extruded Aluminium • Anti-glare poster cover • Wall fixing kit included • Strong back panel



	A4 (210 x 297mm)	A3 (297 x 420mm)	A2 (420 x 594mm)	A1 (594 x 840mm)	510 x 760mm
Deluxe					
Red	5 8971	5 8970	5 8969	5 8968	-
Blue	5 8961	5 8960	5 8959	5 8958	-
Black	5 8966	5 8965	5 8964	5 8963	-
Economy					
Silver	5 8765	5 8766	5 8767	5 8768	5 9815



Rigid Plastic
400 x 600mm
5 8115

Suspended Frames

Impact resistant polyvinyl plastic frame allows easy insertion of rigid signs (up to 3mm). Supplied complete with Wire Suspension Kit for easy fitting from ceiling. Can be used either to display single or double sided signs. Need an alternative size? Contact us today.

Colour	300 x 100mm	450 x 150mm	600 x 200mm
Grey	5 8681	5 8680	5 8674
White	5 8700	5 8701	5 8702
Green	5 8703	5 8704	5 8705
Red	5 8706	-	5 8707
Yellow	5 8713	-	5 8714
Blue	5 8720	-	5 8721
Black	5 8716	-	5 8717



Hanging Snap Frame

Suspending posters from your ceiling is a great way to maximise your advertising space. Ideal for exhibitions, spas, hotels, restaurants or showrooms.

The aluminium snap frame rails include a rubber insert so the poster is securely gripped as it hangs.

- 2 x Slide Hangers and 4 x End Caps
- 2 x 420mm Aluminium Rails
- Landscape and Portrait
- Holds signs up to 1mm thick
- Hang from ceiling with Suspension Kit (sold separately - see page 129)

5 8931



Lockable Frame

A high specification frame which is ideal for both indoor and outdoor environments.

Featuring a strong extruded aluminium frame, tough plastic poster cover and a water seal to protect inside. These frames are finished in silver anodised aluminium which is highly weather resistant.



- 45mm Frame • 2mm Plastic Glazing
- Extruded Aluminium • Waterproof Seal

A4 (210x297mm)	A3 (297x420mm)	A2 (420x594mm)	A1 (594x840mm)
5 3455	5 3456	5 3457	5 3458

Snap Frame A-Board

Double sided aluminium A-Frame, displays two A1 posters (594 x 840mm).

Easy to fold up for storage.

Snap frame action allows graphics to be changed quickly and easily.

Anti glare PVC film protects graphics from the elements.

Weight: 13.5kg
1200 x 600 x 100mm
(H x W x D)

5 9038



Information Point

This information point is ideal for displaying menus, directions, agendas etc.

Aluminium composite back panel with an A4 snap frame.

Complete with a plastic post and heavy duty base.

Please supply high resolution logo when ordering for inclusion on back panel.

Back Panel: 345 x 500mm

5 6195



Health and Safety Law Poster

The HSE Health and Safety Law Poster includes enhanced security features. The features include an image flip hologram with surface relief, optical variable ink, embossed roundel, rounded corners and is printed on recyclable polypropylene material.

Easy to read and understand, providing benefits from increased awareness to both workers and employers.

Unlike the previous poster, there is no need to provide the name and address of the enforcing authority for the premises.

Reduces the administrative costs for employers, who no longer need to include and update additional information.

Flexible Polypropylene
420 x 594mm (A2)
5 8112

Flexible Polypropylene
297 x 420mm (A3)
5 8140



Pocket Guide

Pack of 25 pocket guides, ideal for individual distribution.



Laminated Card
105 x 82mm
5 8133

Magnetic Dry Wipe Boards

These magnetic dry wipe notice boards have a lacquered steel face which can be used as both a magnetic and / or a dry wipe board.

The quality of the lacquer means the board can be wiped clean time after time without smudging or discolouration.

- Lacquered steel face
- Wall fixing kit included
- Soft board back panel
- Silver anodised frame

900 x 600mm 5 8762
1200 x 900mm 5 8763



 <p>Dry Wipe Eraser Foam block with felt base for easy erasing 5 3454</p>	 <p>Magnets 20mm Diameter magnets in white plastic casings 5 3453</p>	 <p>Dry Wipe Marker Pens Produces 2-3mm line width Pack of Four 5 3439 Single Black 5 3433</p>	 <p>Mini Dry Wipe Marker Pen Produces 1-2mm line. Magnet and Dry-wipe eraser on lid 5 1377</p>
---	---	--	--

Magnetic Signs

Need a magnetic sign? Contact us for more information.



A2 Easy Snap Frame

A durable extruded aluminium snap frame finished in a protective silver anodising. This snap frame allows easy insert and removal of posters for the frequent update of information and safety messages.

- 25mm extruded aluminium frame
- Anti-glare poster cover
- Wall fixing kit included
- Strong plastic back panel

A2 594 x 420mm
5 8767



Magnetic Frames

A quick and easy solution for displaying key information in the workplace.

These magnetic document frames are available for both A4 (210 x 297mm) and A3 (297 x 420mm) sheets of paper. The frames are available in various coloured borders making them perfect for use in the workplace to display all types of literature, certificates and information.

For more information see page 60.



Adapt-a-Sign Frames

Use blank frames to display your own messages. Simply print off your message on a standard A4 piece of paper and update messages accordingly.

Pre-printed frames available on page 88.

	Red: 5 6191
	Green: 5 6192
	Blue: 5 6193
	Yellow: 5 6194
	Black: 5 6197

Roller Banners

Roller Banners are the ideal choice for creating a free standing display quickly and easily. The graphic is protected inside the roller cartridge when the stand is not in use and a carry case is provided for easy transportation.

Create your own promotional roller banner for use at exhibitions, trade shops or for in-store point of sale. Simply supply high resolution artwork when ordering or call us for assistance.

- Lightweight aluminium base and top bar
- Lightblock PVC prevents light shining through
- Roller system with fast assembly and storage
- Retractable tensioning system
- Complete with carry case

Lightblock PVC
800 x 2000mm
5 5123



Example

Hazardous Substances

Danger
Hazardous substances
Wear personal protective equipment

1 4268 GM
2 4268 GM

Danger
Corrosive materials
Use hand protection

1 4267 G
2 4267 G

Danger
Silica dust
Approved respirator must be worn

1 4530 G
2 4530 G

Danger
Acid
Wear personal protective equipment

1 4266 G
2 4266 G

Danger
High voltage
Keep away

1 6219 GMP
2 6219 G

Danger
Hazardous waste
Handle with care

1 4290 G
2 4290 G

Warning
This is a multi-hazard area
No unauthorised admittance
All visitors must report to reception

1 6274 K
2 6274 K

Danger
Biohazard
Protective clothing must be worn

1 4525 G
2 4525 G

Warning
UV light
Wear eye protection

1 5463 G
2 5463 G

Danger
Hazardous substances
See data sheets before use

1 4269 GM
2 4269 GM

Warning
Chemical store
No unauthorised access

1 4534 GM
2 4534 G

Danger
Hazardous area
Do not enter

1 4533 GM
2 4533 G

Hazardous Substances

A range of internationally recognised hazardous substance symbols on page 98 - 101.

GHS, ADR & LQ products available.



Hot Works

Danger
Hot works in progress
No unauthorised entry

1 4559 GM
2 4559 GM

Danger
Flammable storage area
No hot works permitted

1 4562 GM
2 4562 GM

Danger
Hot works area
Permit to work must be obtained

1 4560 GM
2 4560 GM

Danger
Hot works area
Approved PPE must be worn

1 4561 GM
2 4561 GM

Asbestos

Danger
Asbestos
Approved respirator must be worn

1 6271 M
2 6271 G

Danger
Asbestos
Permit to work must be obtained

1 6272 GMP
2 6272 G

SITE SAFETY

Danger
Asbestos
No unauthorised entry
Health surveillance in operation

To arrange access please contact:

*State contact details required
5mm Foam PVC
600 x 900mm
5 8049

Danger
Asbestos
No unauthorised persons beyond this point

1 4500 G
2 4500 G

Danger
Asbestos
Do not disturb material
Report accidental damage immediately

1 6270 KQ
2 6270 KQ

Danger
Asbestos insulation
Do not disturb
Avoid damage. Report accidental damage immediately

1 6273 K
2 6273 K

Labels Adhesive Vinyl - 27 x 50mm - Roll of 100

5 9832

5 9765

5 9869



Emergency Shut off

Water mains shut off valve
Keep clear

1 6051 K
2 6051 K

Gas mains shut off valve
Keep clear

1 6035 K
2 6035 K

Electrical mains switch
Keep clear

1 6034 K
2 6034 K

Fuel shut off valve
Keep clear

1 6593 K
2 6593 K

Noise Control

Ear protection zone
No entry without ear protection

1 6250 GMP
2 6250 GM

Caution
Noise level of 85dB(A) or above
Ear protectors must be worn

1 5222 GM
2 5222 GM
8 5222 G

Caution
Noise level of 80dB(A) and 85dB(A)
Ear protectors available on request

1 5223 GM
2 5223 GM
8 5223 G

Warning
Noise hazard
Ear protectors must be worn

1 6251 GM
2 6251 GM
8 6251 G

Multi-Message Design Rules

Multi-message signs can be used to display several safety messages on one sign, consolidating important information into a single focal point and removing the risk of sign clutter. Different safety sign categories can be placed together vertically or horizontally on the same sign. The sign should never combine two categories into one message. Multi-message signs should follow the design principles of BS EN ISO 7010:2020 to ensure maximum levels of message comprehension.



Site Safety



1 6464



1 6404
 2 6404
 7 6404
 8 6404
 Banner with Eyelets
 1270 x 610mm
 5 5087
 Fluted Polypropylene
 Includes company logo
 600 x 400mm
 5 5785



1 6218
 2 6218



1 6217
 2 6217



1 6457



1 6215



1 6429
 2 6429



1 6216
 2 6216
 7 6216
 8 6216



1 6223
 2 6223



1 6222
 2 6222

Confined Spaces



1 6260
 2 6260



1 6262
 2 6262



1 6265
 2 6265



1 6211
 2 6211



1 4327
 2 4327



1 7611



1 6263
 2 6263



1 6264
 2 6264
 8 6264

Permit to Work

Ensure that only competent employees are working in confined spaces.

Pack of 10
 5 8172

Fragile Roof / Risk of Falling



1 6276
 2 6276



1 6232
 2 6232



1 6230



1 6214
 2 6214



1 4299
 2 4299



1 3658
 2 3658



1 6682
 2 6682

Quarry Safety



1 4292



1 4314



1 4311



1 4313

Material Codes

1 Rigid Plastic
 2 Self Adhesive Vinyl
 5 Miscellaneous
 6 Aluminium
 7 PET
 8 Quick Fix

Landscape Sizes

G 300 x 100mm
 H 300 x 250mm
 K 400 x 300mm
 M 600 x 200mm
 P 600 x 400mm
 Q 600 x 450mm

Vehicles



1 6279 G
2 6279 G



1 6278 KQ
2 6278 KQ



1 4032 G
2 4032 G



1 3221 G Banner with Eyelets
7 3221 G 1270 x 610mm
5 3221



1 6275 G Floor Graphic
2 6275 G 600 x 400mm
5 8909



1 4528 G Floor Graphic
2 4528 G 600 x 400mm
5 8923



1 4047 G Floor Graphic
2 4047 G 600 x 400mm
5 8881



1 4033 G Floor Graphic
2 4033 G 600 x 400mm
5 8885



2 1814 E



2 1811 E



2 1813 E



2 4046 E



1 5426 K
2 5426 K



1 7599 KQ



1 4242 HK Floor Graphic
5 4242 600 x 400mm



1 6506 GM



1 4333 M
2 4333 M



Machinery



1 6277 G
2 6277 G



1 4225 G
2 4225 G



1 6210 G
2 6210 G



1 6690 G
2 6690 G



1 6212 G



1 6209 G



1 6213 G



1 6691 G



1 6221 G
2 6221 G



1 6505 G
2 6505 G



1 6220 G
2 6220 G



1 6231 G
2 6231 G



1 4527 K



1 4224 H
2 4224 H



1 6242 Q
2 6242 A

Safety Tags

Highlight defective equipment with a lock out tag out device and with safety tags.

Double sided, matt PVC safety tags supplied in packs of 10 with 150mm cable ties.

5 5071 5 5065

Flammable Substances



1 6206 KQ
2 6206 K



1 6202 KQ
2 6202 KQ



1 6205 KQ
2 6205 KQ



1 6201 KQ
2 6201 KQ



1 6204 KQ
2 6204 KQ



1 6225 KQ
2 6225 K



1 6208 KQ
2 6208 K



1 6203 KQ
2 6203 K



Rigid Plastic
200 x 600mm
5 6226



Rigid Plastic
100 x 400mm
5 6339



1 6207 KQ
2 6207 KQ



1 6234 KQ
2 6234 K



1 6227 KQ
2 6227 K



1 6228 KQ
2 6228 KQ



1 6233 KQ
2 6233 K



1 6484 Q
2 6484 Q

Spill Kit Signs

Spill kit signs inform readers how to effectively respond to any oil, chemical or general fluid spill on site, land or water, in line with EU guidelines and legislation to assist with ISO 14001 compliance.

Our full range of Spill Kit Signs can be found on page 75.



1 6040 H
2 6040 H



1 6041 H
2 6041 H



1 6042 H
2 6042 H



1 6000 W



1 6043 H
2 6043 H



1 6045 EH
2 6045 EH



1 6046 H
2 6046 H

Material Codes

1 Rigid Plastic
2 Self Adhesive Vinyl

5 Miscellaneous
6 Aluminium

7 PET
8 Quick Fix

Landscape Sizes

A 100 x 75mm
E 200 x 150mm

G 300 x 100mm
H 300 x 250mm

K 400 x 300mm
M 600 x 200mm

Q 600 x 450mm
W 900 x 600mm

Portrait Sizes

E 150 x 200mm
H 250 x 300mm

K 300 x 400mm

Large Multi-Message Signs

WAREHOUSE NOTICE

- Caution**
Forklift trucks operating
- No unauthorised persons allowed beyond this point
- High visibility clothing must be worn
- Protective footwear must be worn
- Pedestrians must keep to walkways

1 4307 W

Site Safety Multi-Message Signs

Our full range of multi-message site safety boards are on pages 118 - 120. Choose from our standard range or create your own multi-message site safety board by selecting a template and adding the safety messages you require.

DRIVER NOTICE

- Caution**
Be aware of pedestrians
- No unauthorised entry
- All drivers and visitors must report to reception
- Parking and driver instructions must be obeyed
- Speed limits must be observed

1 4303 W

DRIVER NOTICE

- Caution**
Be aware of pedestrians
- Vehicles must not enter the site without the authority of the site supervisor
- Unsupervised reversing in and out of site is strictly forbidden
- Speed and parking restrictions must be observed

1 4304 W

DRIVER NOTICE

- Caution**
Be aware of pedestrians
- The use of mobile phones while driving is prohibited
- All operators must have a valid forklift licence
- Seatbelts must be worn at all times
- Speed limits must be observed

1 4305 W

FORKLIFT SAFETY

Only adequately trained personnel are allowed to operate lift trucks on this site. Pre-use checks should be carried out in compliance with the Provision and Use of Work Equipment Regulations 1998.

- Caution Forklift trucks operating**
- Daily checks must be completed before use
- Sound horn and drive slowly
- Seatbelts must be worn at all times
- Do not travel with forks raised

1 4066 W

FORKLIFT PARKING

- Engage parking brake
- Forks must be lowered to the floor
- Masts must be upright
- Do not extend forks into the aisle or walkway
- Return keys at the end of your shift

1 4310 Q

DRIVER NOTICE

- Report to site manager before coupling to trailer
- Loading must be completed before coupling to trailer
- Comply with traffic signals at all times
- Parking brake and wheel chocks must be applied if uncoupling trailer
- Do not attempt to pull away on a red light

1 4306 Q

FORKLIFT LOADING

- Complete a daily check of forklift before use
- Ensure all loads are secure and stable
- Ensure brakes are set and wheels are locked on trailers before loading or unloading
- Do not stack the load too high

1 4309 Q

FORKLIFT SAFETY

- Do not use truck until a pre-shift inspection has been completed
- Report all defects immediately
- Record and report all near miss incidents

1 4308 Q

Forklift Inspections

Employers have a duty of care to ensure all employees operating or working in the vicinity of forklifts are protected from harm. Good to Go Safety offers a simple yet effective solution for forklift safety with daily or weekly inspections. Complete pre-use checks as part of your forklift safety maintenance programme and ensure all staff are aware of the forklifts' status at all times. See pages 131-135 for more information.



Safe Working Loads

Pallet Racking

SAFE WORKING LOADS

- Conduct regular inspections to check for:
 - correct application and use
 - loads within allowable safe limits
 - accidental damage, or disengagement of structural components
- Report all damage to the racking safety officer
- Do not alter the structure without either:
 - checking effects against manufacturer's technical data
 - obtaining approval from supplier
- Do not climb racking
- Refer to SEMA "Code of practice for the use of static pallet racking"
- If in doubt always check with supplier

MAXIMUM BEAM LOAD: 500kg

MAXIMUM BAY LOAD: 1000kg

All loads to be uniformly distributed

Racking supplied by: _____

Date supplied: _____

5mm Foam PVC
600 x 450mm
5 6355

Mezzanine Flooring

SAFE WORKING LOADS

- Conduct regular inspections to check for:
 - correct application and use
 - loads within allowable safe limits
 - accidental damage, or disengagement of structural components
- Report all damage to the racking safety officer
- Do not alter the structure without either:
 - checking effects against manufacturer's technical data
 - obtaining approval from supplier
- Refer to SEMA "Guide to the specification of Mezzanine Floors & SEMA-FEM users code"
- If in doubt always check with supplier

MAXIMUM FLOOR LOAD: 500kg

MAXIMUM PALLET LOADS: 5000kg

Racking supplied by: _____

Date supplied: _____

5mm Foam PVC
600 x 450mm
5 6357

Cantilever Racking

SAFE WORKING LOADS

- Conduct regular inspections to check for:
 - correct application and use
 - loads within allowable safe limits
 - accidental damage, or disengagement of structural components
- Report all damage to the racking safety officer
- Do not alter the structure without either:
 - checking effects against manufacturer's technical data
 - obtaining approval from supplier
- Do not climb racking
- Refer to SEMA-FEM "Guidelines for the Safe use of Static Steel Racking and Shelving Users Code"
- If in doubt always check with supplier

MAXIMUM PER ARM: 500kg

MAXIMUM PER COLUMN SIDE: 1000kg

All loads to be uniformly distributed

Racking supplied by: _____

Date supplied: _____

5mm Foam PVC
450 x 600mm
5 6356

Fineline Marker

Use the permanent marker pen to complete weight loads and add details. 5 3430



Magnetic Racking Signs

Advise of temporary safety issues and / or weight restrictions with these magnetic signs which allow quick and easy application to racking beams.

<p>Max load capacity 500kg UDL per shelf</p> <p>100 x 75mm 5 8902</p>	<p>Max load capacity 1000kg UDL per shelf</p> <p>100 x 75mm 5 8903</p>	<p>Max load capacity 1200kg UDL per shelf</p> <p>100 x 75mm 5 8904</p>
<p>Max load capacity 2000kg UDL per shelf</p> <p>100 x 75mm 5 8905</p>	<p>Max load capacity kg UDL per shelf</p> <p>100 x 75mm 5 8907</p>	<p>DO NOT CLIMB ON RACKING</p> <p>100 x 75mm 5 8908</p>

This racking has been offloaded

Do not use until further notice

1000 x 75mm
5 8888

Do not use

Awaiting inspection

1000 x 75mm
5 8889

Caution
This racking is damaged

Do not use

1000 x 75mm
5 8901

Rack Protector



A cost effective protective bumper which minimises the impact of forklift collisions. Supplied with two velcro straps (700mm) for quick and easy fixing to most uprights

- Polyethylene - no rusting or denting
- Waterproof and chemical resistant
- Ability to reform itself after an impact
- Slim fit provides minimal aisle intrusion
- Manufactured to comply with BS6399-1: 1996

Clips to any frame width between 75-90mm - Height: 500mm

5 9235

Racking Sack

Made from tough waterproof polyester, this racking sack can adequately withstand the rigours of industrial environments.

The re-usable waste sack helps promote a clean and tidy work place and is suitable for racking systems between 900-1100mm deep.

Quickly fixed / removed to the end of racking by using the hooks provided. When hung it has a large open mouth to easily receive waste, without encroaching into the floor area.

Alternative colours and messages are available upon request.

920 x 1000mm (W x H)
5 8933



Impact Protection

The impact protection system cushions and warns of protruding corners, edges, vulnerable pipes and protects many other areas such as walls, kerbs, trolley parks, vehicles, plant and machinery and is ideal for racking and shelving. Supplied in standard lengths of 1000mm and manufactured from high-grade flexible age resistant polyurethane foam with self adhesive or push on profiles. Protects staff from injury and property from damage. Can be easily cut to the required length.

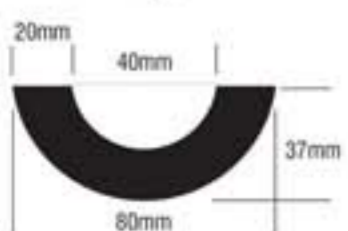

40mm Pipe Protection Polyurethane Foam with Self Adhesive Backing
5 9222



85mm Pipe Protection Polyurethane Foam with Self Adhesive Backing
5 9223



Semi-circular 40/40 Polyurethane Foam
5 9231



Trapeze 40/40/8 Polyurethane Foam
5 9229



Trapeze 40/80/8 Polyurethane Foam
5 9230



Semi-circular 40/32 Polyurethane Foam with Self Adhesive Backing
5 9225



Semi-circular 40/40 Polyurethane Foam with Self Adhesive Backing
5 9221



Rectangle 60/20 Polyurethane Foam with Self Adhesive Backing
5 9226



Wipe Clean Signs

We have developed a range of rigid pvc signs with a specialist dry-wipe surface which allows the sign to be updated with a water based dry-wipe pen.

This range allows managers to highlight key performance information and messages as and when required. Simply wipe this range of signs clean and re-use time after time.



ACCURACY

DAYS WITHOUT A PICKING ERROR

RIGHT FIRST TIME

300 x 400mm 5 4700
450 x 600mm 5 4704

TIMELINESS

DAYS WITHOUT A LATE SHIPMENT

WE SHIP ON TIME

300 x 400mm 5 4701
450 x 600mm 5 4705

SAFETY

DAYS WITHOUT AN ACCIDENT

SAFETY FIRST

300 x 400mm 5 4702
450 x 600mm 5 4706

SERVICE

DAYS SINCE WE HAD A PRODUCT RETURNED

CUSTOMER SATISFACTION

300 x 400mm 5 4703
450 x 600mm 5 4707

DANGER

400 x 300mm 5 4708
600 x 450mm 5 4711

THINK

400 x 300mm 5 4709
600 x 450mm 5 4712

SAFETY FIRST

400 x 300mm 5 4710
600 x 450mm 5 4713

Identification Letters / Numbers

A range of self adhesive letters and numbers for the identification of storage locations, bin numbers, aisle numbers, plant and equipment or many other applications. Each letter or number is available in Black on White or Black on Yellow.
* When ordering: State the code, letter / number and your choice of colour (white or yellow). E.g. 5 9670 / K / Yellow



Label Size	A-Z (26 pack)	Singular Letter (10 pack)*	0 - 9 (10 pack)	Singular Number (10 pack)*
45 x 130mm	5 9840	5 9670	5 9846	5 9676
38 x 90mm	5 9841	5 9671	5 9847	5 9677
21 x 56mm	5 9842	5 9672	5 9848	5 9678
14 x 19mm	5 9843	5 9673	5 9849	5 9679

Magnetic Wipe Clean / Write-on Rolls



Suitable for racking and shelving, can be easily cut to size and written on with a dry wipe marker pen. Cost effective, write-on, wipe off labelling.
*Other colours available upon request.

Colour	Size	Code
White	20mm x 10m	5 9890
White	30mm x 10m	5 9892
White	50mm x 10m	5 9894
White	70mm x 10m	5 9896

Magnetic Document Frames



A quick and easy solution for displaying key information in the workplace. These magnetic document frames are available for both A4 (210 x 297mm) and A3 (297 x 420mm) sheets of paper. The frames are available in various coloured borders making them perfect for use in the workplace to display all types of literature, certificates and information.

The strong magnetic border allows them to be applied to metal filing cabinets, racking, magnetic whiteboards or any other flat steel surface.

Insert a sheet of A4 or A3 paper within the frame to display content. Content can be easily updated as / when required by simply lifting the magnetic strip, this also makes it simple to relocate the frame whenever necessary. Ideal for use in 5S or 6S lean manufacturing displays where colour coded frames may prove beneficial.

The choice of common "safety colour" borders means that the frame can also be coordinated with key safety messages (mandatory, prohibition, warning and safe condition).

Document Pockets

Industrial pockets for keeping documents clean and easily accessible, ideal for control of fast moving stock.

Pocket Dimensions: 220 x 310mm
Pack Size: 10

Magnetic
A4 (297 x 210mm) 5 9884
A4 (210 x 297mm) 5 9885

Self Adhesive
A4 (297 x 210mm) 5 9880
A4 (210 x 297mm) 5 9881



Label Holder

Magnetic label holder, supplied with white card inserts and clear plastic cover strips.

Size Pack Size Code
80 x 30mm 100 5 9874
80 x 50mm 100 5 9875



Self Adhesive Tabs

10 x 25mm
Pack of 4
5 8724



Size	A4	A3
Colour	Frame: 240 x 327mm Paper: 210 x 297mm	Frame: 327 x 450mm Paper: 297 x 420mm
Black	5 7400	5 7406
Red	5 7401	5 7407
Yellow	5 7402	5 7408
Green	5 7403	5 7409
Blue	5 7404	5 7410
Yellow & Black	5 7405	5 7411

Quality Control Signs



Quality Control Tags

Matt PVC - 80 x 150mm - Double Sided - Pack of 10 - Supplied with 150mm Cable Ties



Quality Control Labels

Matt Self Adhesive Vinyl - Roll of 100 - 50 x 20mm



Shipping Labels

Self Adhesive Vinyl - 75 x 100mm - Roll of 250

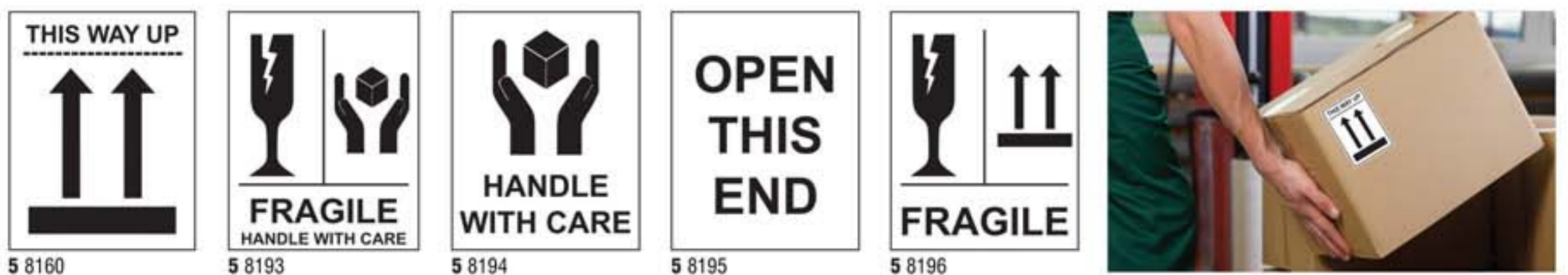

Pallet Topper

The pallet topper sits on top of pallets as a warning to not double stack a pallet. A simple damage protection solution. Manufactured from pre-creased cardboard, which is easily folded and slotted together to create a 170 x 170 x 150mm pyramid. Can be easily secured with pallet strapping or under clear pallet wrap.

Pre-creased Cardboard
170 x 170 x 150mm
5 8934



Lifting Labels

Required by the Manual Handling Operations Regulations 1992 (as amended 2002), labels should be installed onto heavy packages and other items to indicate a manual handling risk.



Self Adhesive Vinyl
50 x 50mm
Roll of 500
5 4030

Pipeline Marking 300 x 40mm - Self Adhesive Vinyl - Pack of 5



Pipeline identification markers are manufactured from high quality self adhesive vinyl. Each marker has a twin flow direction system so you can simply remove the direction which is not required.

Additional markers are available upon request.

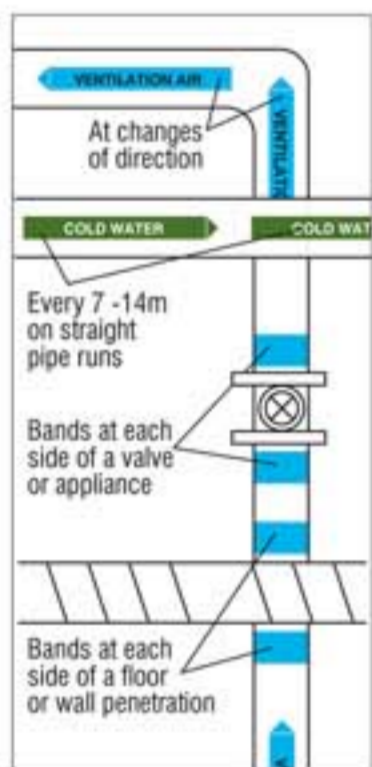

STEAM 5 9941	NON DRINKING WATER 5 9932	ELECTRICITY 5 9945
COLD WATER 5 9918	WASTE WATER 5 9919	COMPRESSED AIR 5 9980
CONDENSATE 5 9923	DRINKING WATER 5 9924	AIR 5 9979
HEATING 5 9928	HOT WATER 5 9927	
COOLING WATER 5 9921	FRESH WATER 5 9929	
HYDROGEN PEROXIDE 5 9963	HEATING FUEL OIL 5 9973	
DIESEL OIL 5 9978	FUEL OIL 5 9975	
OIL 5 9965	ALCOHOL 5 9969	
NITRIC ACID 5 9948	SULPHURIC ACID 5 9950	
HYDROCHLORIC ACID 5 9960	SODIUM HYDROXIDE 5 9962	
ACID 5 9946	CAUSTIC SODA 5 9956	
NITROGEN 5 9902	GAS 5 9903	
CO2 5 9917	NATURAL GAS 5 9909	
PROPANE 5 9910	METHANE 5 9911	

Engraved Tags

Our valve tags are engraved to give better quality than printed or stamped versions. See page 95 for more information.



Pipeline Information Poster

Pipeline Marking
What you need to know

The Health and Safety (Safety Signs and Symbols) Regulations 1996 require employers to mark suitable pipes to the standards which contain or transport dangerous substances. BS 1712: 2014 Identification of Pipelines and Services, specifies the colours to be used for the identification of pipes containing or transporting dangerous substances, including controls for electrical services and ventilation.

Colour	Pipe Contents	BS4800 Colour Reference
White	Water	12 D 05 Green
Grey	Steam	10 A 03 Silver - Grey
Blue	Oil	06 C 39 Brown
Green	Gas	08 C 35 Yellow Ochre
Black	Acids & Alkalis	22 C 37 Lilac
Light Blue	Air	20 E 51 Light Blue
Yellow	Other Liquids	00 E 53 Black
Red	Electrical Services & Ventilation	04 E 53 Red
Orange	Fire Fighting	04 E 53 Red
White	Warning	08 E 51 Yellow
Blue	Fresh Water	18 E 53 Auxiliary Blue

Positioning Markers
At changes of direction

Hazardous Substances
The Health & Safety (Safety Signs and Symbols) Regulations 1996 state that pipes containing hazardous substances must be clearly marked with the appropriate symbols.

Rigid Plastic
400 x 600mm
5 8131

Directional Flow Tape Self Adhesive Vinyl - 50mm x 33mm

Self adhesive marking tape with directional arrows indicating direction of flow in a pipe. Other colours available on request.

5 9876	5 9877	5 9879	5 9889	5 9888	5 9878 (See through)
--------	--------	--------	--------	--------	----------------------



Pipeline Bands Self Adhesive Vinyl - 150 x 980mm

Steam Grey / Silver. BS4800: 10 A 03 5 9990	Water Green. BS4800: 12 D 45 5 9989	Air Light Blue. BS4800: 20 E 51 5 9994	Gas Yellow Ochre. BS4800: 08 C 35 5 9992
Acids / Alkalis Lilac. BS4800: 22 C 37 5 9993	Oils Brown. BS4800: 06 C 39 5 9991	Fresh Water Auxiliary Blue. BS4800: 18 E 53 5 9999	Other Liquids Black. BS4800: 00 E 53 5 9995
Warnings Yellow. BS4800: 08 E 51 5 9998	Fire Fighting Red. BS4800: 04 E 53 5 9997	Electricity / Ventilation Orange. BS4800: 06 E 51 5 9996	

Additional pipeline bands and markers are available upon request. Contact us if you can't see what you require.

GHS Signs and Labels

Businesses shipping hazardous goods are responsible for classifying, marking and packaging the goods with the appropriate GHS symbol. ADR sets out the requirements for the classification, packaging and certification of dangerous goods being transported by road. Our full range of GHS labels are available on page 99.

1 4540 U 2 4540 U	1 4541 U 2 4541 U	1 4543 U 2 4543 U	1 4544 U 2 4544 U	1 4545 U 2 4545 U	1 4548 U 2 4548 U	1 4547 U 2 4547 U
----------------------	----------------------	----------------------	----------------------	----------------------	----------------------	----------------------



Domed Mirrors

These domed mirrors are manufactured from 100% recyclable PMMA and are ideal for shops and warehouse premises.

Both the quarter and half dome are supplied with wall fixings.

The full dome includes a chain kit for hanging from ceiling (4 x 1metre long chains).



Description	Size	Viewing Distance	Direction	Code
Quarter Dome	470mm	4 metres	2 way 90°	5 9217
Half Dome	660mm	8 metres	3 way 180°	5 9240
Full Dome	660mm	8 metres	4 way 360°	5 9241



Convex Mirrors

A range of light and virtually unbreakable convex mirrors supplied with a three year guarantee. Includes fixings.

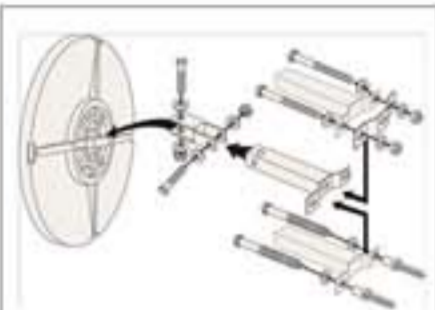

Convex mirrors are supplied complete with fully adjustable bolts & bracket kit for either wall mounting or for posts (60 - 90mm diameter).

The kit is robust and tested to withstand winds of up to 183 km/h. Easy to install, allows precise adjustment for optimal positioning.



Multi-Purpose Internal / External Use
Ideal for use in warehouses, high-risk collision areas, stock surveillance, work station safety and direct observation of hidden parts of machinery.

Size	Viewing Distance	Code
300mm	3 metres	5 9201
400mm	5 metres	5 9202
500mm	7 metres	5 9203
600mm	11 metres	5 9204
700mm	15 metres	5 9205
800mm	20 metres	5 9206



Surveillance Internal Use
Recommended for shop security as a deterrent to theft. Effective for monitoring hospital corridors, reception areas and door access control.

Size	Viewing Distance	Code
300mm	2 metres	5 9207
400mm	4 metres	5 9208
500mm	6 metres	5 9209
600mm	8 metres	5 9210



Traffic Internal / External Use
These mirrors assist road safety and can help eliminate blind spots at corners, concealed entrances / exits, car parks and junctions.

Size	Frame Size	Viewing	Code
600 x 400mm	680 x 500mm	9 metres	5 9213
800 x 600mm	950 x 750mm	20 metres	5 9214
1000 x 800mm	1150 x 950mm	30 metres	5 9215

Security Eyes

Research indicates that the feeling of being watched can influence the behaviour of people, leading to reduction in crime. Use alongside our standard signs to reinforce security and safety messages.



1 1751 DGJMX



1 1752 DGJMX



Security Signs

For more security and CCTV signs see pages 80 - 81.

Mirror Messages 405 x 485mm - Self Adhesive Backing

A practical and innovative way to portray safety messages. These acrylic mirrors provide useful reminders.



5 9218



5 9236



5 9238



5 9239



Reflector Signs

The bottom half of these signs are designed to be read in vehicles' mirrors. Ensuring drivers are aware of procedures and that safety is maintained.



1 4293 P



1 4294 P



1 3231 P



1 5247 P

Material Codes

1 Rigid Plastic 2 Self Adhesive Vinyl 5 Miscellaneous

Landscape Sizes

D 150 x 100mm G 300 x 100mm J 400 x 200mm M 600 x 200mm P 600 x 400mm U 100 x 100mm X 200 x 100mm

Near Miss Reporting

The HSE defines a near miss as 'an event not causing harm, but one that has the potential to cause injury or ill health'. This can include dangerous occurrences that are reportable, as defined in the Reporting of Injuries, Diseases and Dangerous Occurrences Regulations 2013 (RIDDOR).

Near Miss Record Book

This Near Miss Record Book contains clear guidance on what a Near Miss Incident is, the employers and employee's responsibility and guidance on completing a record.

Near miss records are used to inform management of incidents, to help ensure that serious injuries and accidents do not occur in the future.

The perforated top allows forms to be easily removed from the book for safe storage / management records.

A4 Book
53 Incident Forms
5 5937



Near Miss Record Book Station

A near miss record book is an ideal way to keep track of incidents that had the potential to result in injury, allowing you to improve your health and safety measures and policies in the future. Ensure your employees make good use of the record book by wall-mounting it with this useful station (pre-drilled for easy mounting). A printed "missing" message is displayed on the station and will show when the book has been removed. (Books ordered separately).

3mm Thick Plastic
360 x 220 x 15mm
5 5938



Near Miss Station

Take a proactive approach to improving site safety and ensure that all near misses and incidents are recorded and acted upon with this near miss station. Includes a suggestion box to store near miss slips.

(Slips sold separately)

10mm Foam PVC
600 x 440mm
5 6687



Near Miss Slips

Allow near miss incidents to be recorded and show the actions taken to eliminate repeat occurrences.

Pack of 10
Matt PVC
80 x 150mm
5 6688

NEAR MISS / INCIDENT REPORT	NEAR MISS / INCIDENT ACTION
Report Name: <input type="checkbox"/> Personnel <input type="checkbox"/> Equipment <input type="checkbox"/> Other <input type="checkbox"/> Location: _____ What Description of the Incident / Near Miss: _____ Date: _____ Time: _____ Reported By: _____ Shift: _____ Suggestions for Improvement: _____ Severity Rating: A - Critical: (potential of major loss of body part or significant loss of production / equipment) B - Major: (potential of serious injury / damage to tool) C - Minor: (potential of minor injury / damage to tool) D - Near Miss: (no event with the potential to have resulted in injury/damage to tool)	Person taking Responsibility: _____ Estimated Completion Date: _____ Details of Action Taken: _____ _____ _____ _____ _____ Date: _____ Time: _____ Work Request Number: _____ Custom Feedback provided to Employee <input type="checkbox"/> Custom Action as Completed and Closed <input type="checkbox"/>

Front

Reverse

Suggestion Box

Fabricated in yellow polystyrene with a clear acrylic A5 sign holder on the front (insert your message of choice). The pocket behind the holder can be used to store your near miss tags. Sliding door at the rear gives access to remove the contents. The box is freestanding but can also be wall mounted.

Yellow Polystyrene with a Clear Acrylic front
W 275 x H 275 x D 100mm with 145mm Wide Slot
5 6689



Inspection Station

This wall mounted information station provides details of equipment inspection processes whilst offering easy access to inspection check books from a tidy central location.

For more information see page 134.

10mm Foam PVC
700 x 750mm
5 1335



Equipment Inspections



Good to Go Safety is a multi-award winning system which enables companies to complete safety inspections on workplace equipment.

The system is perfect for ensuring warehouse equipment such as forklifts, ladders and pallet racking are in safe working order prior to use.

Simply attach a status tag to the equipment, use the corresponding check book to carry out an inspection, insert the completed checklist inside the tag. A duplicate carbon copy is created for your management records, providing invaluable evidence of a Safe Equipment Management System (SEMS) in the event of an accident.

For more information see pages 131-135.



Components

Status Tag	5 1301	Information Station	5 1335	Tamper Evident Seals	5 1307
Wallet & Pen	5 1308	Dispenser	5 8099	Weather Resistant Holder	5 8109

Equipment Type	Check Book	Weekly Kit	Daily Kit	A2 Poster
Forklift	5 1302	5 1309	5 1313	5 1360
Ladder	5 1304	5 1311	5 1315	5 1361
Pallet Truck	5 1336	5 1337	5 1338	5 1364
Racking	5 1305	5 1312	5 1316	5 1362
Podium Steps	5 1330	5 1331	5 1332	5 1389
Forklift Work Platform	5 1348	5 1349	5 1350	5 1390
Overhead Crane	5 1351	5 1352	5 1353	5 1391
Fleet Vehicles	5 1306	5 1328	5 1329	5 1387
Trailers	5 1339	5 1340	5 1341	5 1365
MEWP	5 1322	5 1323	5 1324	5 1366
Loader Crane	5 1354	5 1355	5 1356	5 1367
Bespoke	5 1317	5 1333	5 1334	-

Multi-Lingual Signs

Multi-Lingual signs are a useful way to get key safety messages across to employees and the public, within areas known to have a large percentage of people where English may not be their primary language. We are able to supply signs in a wide range of languages, so if you can't find the language or message that you require please contact us for a quote.

Welsh



**Dim ysmygu
No Smoking**

1 3025 **EH**
2 3025 **E**



Mae ysmygu yn y fangre hon yn erbyn y gyfraith

It is against the law to smoke in these premises

160 x 230mm
Rigid Plastic 5 3039
Adhesive Vinyl 5 3044

English, French & German



Fire action
if you discover a fire

1 1435 **EH**
2 1435 **EH**
3 1435 **EH**



Fire action
if you discover a fire

1 1437 **EH**
2 1437 **EH**
3 1437 **EH**



Fire action
if you discover a fire

1 1436 **E**
2 1436 **E**
3 1436 **EH**
4 1436 **E**



1 1424 **H**
2 1424 **H**

English & Polish



Safety helmets must be worn
Należy nosić kaski ochronne

1 5250 **E**
2 5250 **E**



Ear protection must be worn
Należy założyć środki ochrony uszu

1 5239 **EHK**
2 5239 **EHK**



High visibility jackets must be worn
Należy nosić kamizelki odblaskowe

1 5248 **EK**
2 5248 **EK**



Protective footwear must be worn
Należy nosić obuwie ochronne

1 5249 **E**
2 5249 **E**



Eye protection must be worn
Należy założyć środki ochrony oczu

1 5238 **H**
2 5238 **H**



Caution
Forklift trucks operating
Uwaga
na wózki widłowe

1 4298 **K**
2 4298 **K**



Caution
Mind the step
Uwaga
stopień

1 4296 **E**
2 4296 **E**



Fire exit
Wyjście ewakuacyjne

1 2078 **H**
2 2078 **H**



Fire assembly point
Punkt zbiórczy na wypadek pożaru

1 2079 **C**
2 2079 **C**



First aid
Pierwsza pomoc

1 6054 **H**
2 6054 **H**



Fire extinguisher
Gaśnica

1 1058 **E**
2 1058 **E**



Fire alarm call point
Punkt uruchamiania alarmu pożarowego

1 1057 **E**
2 1057 **E**



Fire door keep shut
Drzwi przeciwpożarowe starannie zamykać

1 1647 **A**
2 1647 **A**



Fire exit keep clear
Wyjście ewakuacyjne nie zastawiać

1 1648 **H**
2 1648 **H**



No admittance for unauthorised personnel
Nieupoważnionemu personelowi wstęp wzbroniony

1 3243 **EH**
2 3243 **EH**



No Smoking
It is against the law to smoke in these premises
Palenie wzbronione
Palenie na terenie tego budynku jest niezgodne z prawem

1 3302 **EH**



No Smoking
Palenie wzbronione

1 3301 **EH**
2 3301 **E**



Fire action
if you discover a fire

1 1440 **EH**
2 1440 **EH**
3 1440 **E**
4 1440 **E**



Fire Action

1 1441 **EH**
2 1441 **EH**

Custom Multi-Lingual Signs

If you have a specific language requirement, you can supply us with the required text or we can supply a translation service at an additional charge.



RESTROOMS
BAÑOS









Please contact us for a quote

Floor Safety Tapes

50mm x 33m - Self Adhesive

Sub surface printed and over laminated in hard wearing, anti-slip polycarbonate film. We advise the use of primer, edge sealer and floor cleaning fluids for improved adhesion.



	5 8630		5 8631		5 8632
	5 8602		5 8606		5 8605
	5 8603		5 8604		5 8601

Reflective Tapes

High visibility, retro-reflective marking tape that is resistant to corrosion, weather and most solvents. Shines brightly in the dark when light is directed at it.









Self Adhesive
50mm x 25m
5 8646



Self Adhesive
50mm x 25m
5 8643

Pallet Marking

Tough, highly visible yellow floor markers with aggressive adhesive backing for application to clean, flat surfaces. Capable of withstanding everyday traffic in a fully operational warehouse. Perfect to highlight pallet positions, walkways and traffic flow. Other colours available upon request.

	10 x Centre Pallet Locators 300 x 300mm 5 9505		10 x Edge Pallet Locators 300 x 200mm 5 9524
	10 x Corner Pallet Locators 200 x 200mm 5 9508		100 x Walkway Locators 90mm Diameter 5 9509
	100 x Traffic Flow Markers 90 x 90mm 5 9506		10 x Walkway Footprints 300 x 100mm 5 9507



Floor Graphics

Sub-surface printed floor graphics over-laminated with a hard wearing, anti-slip polycarbonate film. Use primer, edge sealer and floor cleaner for improved adhesion.



600 x 400mm
5 8923



600 x 400mm
5 8881



600 x 400mm
5 8885



600 x 400mm
5 4242



600 x 200mm
5 8807



600 x 200mm
5 8813



600 x 200mm
5 8811



600 x 200mm
5 8815



400 x 200mm
5 8809



400 x 400mm
CV0007



400 x 400mm
CV0006



400mm Dia
5 8783



400mm Dia
5 8465



400mm Dia
5 8760



400mm Dia
5 8280



400mm Dia
5 8281



All our floor graphics are available in different sizes or colours.



200 x 200mm
CV0017



200 x 200mm
CV0018



200 x 200mm
CV0019



200 x 200mm
CV0020



200mm Dia
CV0045



200mm Dia
CV0043



600 x 200mm
5 4995



200 x 200mm
CV0025



200 x 200mm
CV0026



200 x 200mm
CV0022



200 x 200mm
CV0023



200 x 200mm
CV0024

External Floor Graphics

We can now supply floor graphics on a high quality external grade material for application to textured outdoor ground surfaces such as asphalt, concrete, and pavements. If you require external floor graphics please contact us for a quote.



1000 x 50mm
5 8617



1000 x 50mm
5 8615



1000 x 50mm
5 8616



300 x 300mm
5 8485



300 x 300mm
5 8486



300 x 300mm
5 8487



300 x 300mm
5 8488



300 x 300mm
5 8491



300 x 300mm
CV0042



300 x 300mm
CV0044



300 x 100mm
5 8749

Custom Floor Graphics

A great solution to highlight potential dangers or identify warehouse aisle / bay letters and numbers. Simply supply us with your message of choice, logo or photograph and we will print your floor graphic.



400mm Diameter
5 8862



400 x 600mm
5 8855



Floor Preparation

A clean surface is vital to the performance and longevity of floor graphics and tapes. Thorough cleaning and priming of all surfaces, together with edge-sealing to prevent moisture and other contaminants increases the service life of your products.



Edge Sealer
140ml
5 9699



1L Floor Cleaner
5 8827



1L Floor Primer
5 9698

Floor Graphics

Sub-surface printed floor graphics over-laminated with a hard wearing, anti-slip polycarbonate film. Use primer, edge sealer and floor cleaner for improved adhesion.

 400mm Dia 5 8802	 400mm Dia 5 8746	 400mm Dia 5 8801	 400mm Dia 5 8744	 400mm Dia 5 8786	 400mm Dia 5 8864	 400mm Dia 5 8803
 400mm Dia 5 8804	 400mm Dia 5 8806	 400mm Dia 5 8805	 400mm Dia 5 8787	 400mm Dia 5 8799	 400mm Dia 5 8745	 400mm Dia 5 8788
 400 x 600mm 5 8732	 400 x 600mm 5 8730	 400 x 600mm 5 8731	 400 x 600mm 5 8820	 400 x 600mm 5 8733	 400 x 600mm 5 8828	
 400 x 600mm 5 8821	 400 x 600mm 5 8736	 400 x 600mm 5 8738	 400 x 600mm 5 8789	 400 x 600mm 5 8817	 400 x 600mm 5 8818	
 400 x 600mm 5 8819	 400 x 600mm 5 8822	 400 x 600mm 5 8739	 400 x 600mm 5 8740	 400 x 600mm 5 8737	 400 x 600mm 5 8741	
 400 x 600mm 5 8823	 400 x 600mm 5 8825	 400 x 600mm 5 8826	 400 x 600mm 5 8735	 400 x 600mm 5 8734	 400 x 600mm 5 8824	

Floor Safety & Demarcation

Anti-Slip Mats 610 x 150mm

With aggressive pressure sensitive adhesive for bonding to most floor surfaces.



Caution
5 9634

Watch your Step
5 9635

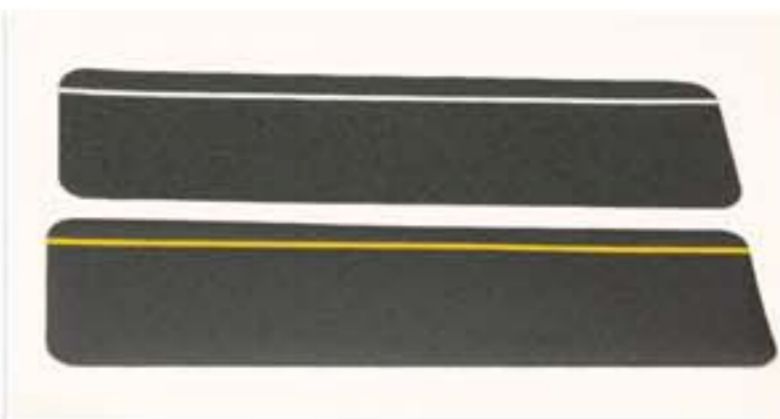

Reflective Strip
5 9696

Photoluminescent
5 9697



Black & Yellow Chevron
5 9695

Anti-Slip Tapes

Self Adhesive - 50mm x 18m

Anti-slip tape provides an ideal solution to slippery surfaces and steps. Recommended for internal use in pedestrian traffic routes. It has a near "diamond hard" aggregate and a conformable pressure adhesive giving strong adhesion to most surfaces, such as wood, concrete, steel or checker plate.



5 9623

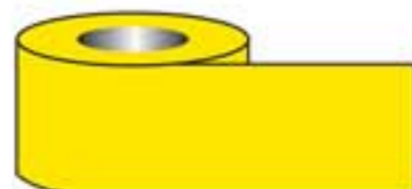

5 9624



5 9694 Photoluminescent



5 9625



Floor Safety Tapes Self Adhesive - 50mm x 33m

Heavy duty plasticized PVC tape with an aggressive pressure sensitive adhesive backing. Quick and easy to put down and provides smooth, straight lines which are highly visible.



5 8603



5 8604



5 8601



5 8602



5 8630

This tape provides instant demarcation lines for gangways and restricted areas. Perfect for use in sports halls, warehouses, hospitals etc.



5 8631



5 8632



5 8606



5 8605



Class C Photoluminescent Tapes

Self Adhesive - 10m Length

Perfect for highlighting around safety equipment or as part of your way guidance marking.



40mm Wide
5 8644

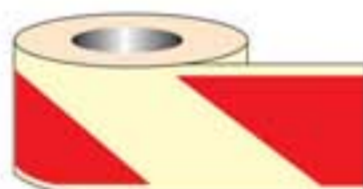

40mm Wide 80mm Wide
5 8641 5 8642



40mm Wide 80mm Wide
5 8647 5 8648

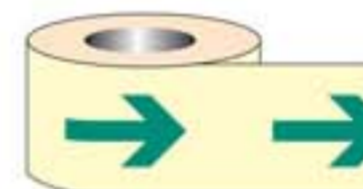

40mm Wide 80mm Wide
5 8656 5 8657



20mm Wide 40mm Wide 80mm Wide
5 8658 5 8659 5 8660



40mm Wide 80mm Wide
5 8653 5 8654



40mm Wide 80mm Wide
5 8650 5 8651

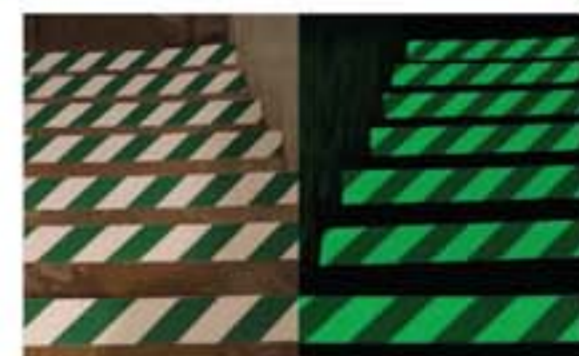

Deluxe Class D Floor Markers

Aluminium back provides extra strength and durability in high traffic areas. Anti-slip surface. Photoluminescent Class D Aluminium with self-adhesive backing.



125mm Dia
5 8664

175 x 110mm
5 8665

90mm Dia
5 8663

Class C Floor Markers

Photoluminescent way finding floor markers are an effective method of marking escape routes. The markers have an anti-slip surface and strong adhesive backing.

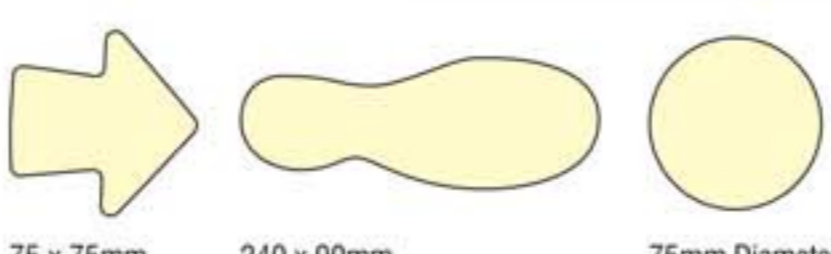
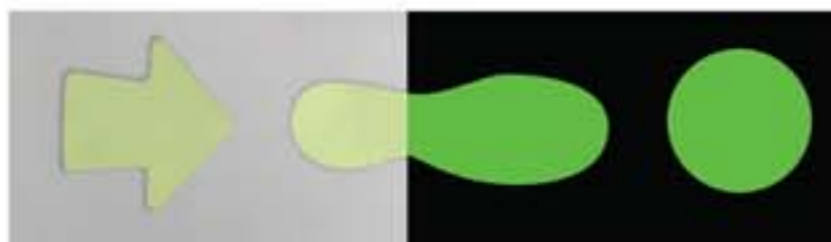

75 x 75mm
Pack of 20
5 8670

240 x 90mm
Pack of 20
5 8672

75mm Diameter
Pack of 20
5 8671



Stencils

Laser cut clear PET (polyethylene) stencils – 100% recyclable, high chemical resistance – allowing them to be re-used after numerous paint applications. Hard wearing with high impact strength.

Bespoke designs can be created (max size 600 x 900mm) contact us with details for a quote. Ideal for repeating key safety messages throughout car parks and warehouses by simply painting over the stencil at required locations.



 600 x 400mm 5 9662	 600 x 400mm 5 9660	 600 x 400mm 5 9602	 300 x 400mm 5 8441	 300mm 0 - 9 (10 piece kit) 5 9642 A-Z (26 piece kit) 5 9643	 150mm 0 - 9 (10 piece kit) 5 9640 A-Z (26 piece kit) 5 9641
 600 x 400mm 5 9537	 600 x 400mm 5 9649	 600 x 400mm 5 9585	 300 x 400mm 5 9648	 100mm A-Z and 0-9 (36 piece kit) 5 9646	 100mm A-Z and 0-9 (36 piece kit) 5 9646
 600 x 400mm 5 9589	 600 x 400mm 5 9612	 600 x 400mm 5 9613	 600 x 400mm 5 9536	 400 x 300mm 5 9647	 50mm A-Z and 0-9 (36 piece kit) 5 9645 25mm A-Z and 0-9 (36 piece kit) 5 9644

Spray Paints

Long lasting, durable synthetic resin paint. Easy to use, simply shake the can, insert into an applicator and apply.

Produces markings that are highly visible and are abrasion and chemical resistant. Adheres to most surfaces - concrete, asphalt, tarmac, metal and tiles.

Economical - one 750ml can produces a 50mm wide line approximately 50-90 metres long (dependent on surface). Environmentally friendly. Conforms to the latest EU regulations.



5 9607 5 9605 5 9606

Paint Applicators

The hand held applicator is perfect for use with stencils giving you free movement, whilst the 4-wheel applicator is ideal for creating neat, straight lines.

Hand Held Applicator



This hand applicator has been specially designed for comfortable use. Ideal for use with stencil sets. Makes marking steps or obstructions easy.
5 9604

4-Wheel Applicator

This 4 wheel paint applicator produces 50 - 75mm wide line marking of roughly 25 metres per minute.

Minimal assembly is required and the rear wheels are removable to get up close to walls and racking.

Colours can be changed quickly without cleaning the machine.

5 9603



Line Marking Kit

This handy kit contains everything you need to mark out warehouses, factories or car parks.

The four wheel paint applicator produces a 50 - 75mm wide line marking of roughly 25 metres per minute.

The long lasting synthetic resin spray paint produces highly visible, chemical resistant marking that adheres to most surfaces such as concrete, asphalt, metal and more.

Additional paint can be ordered if required – if you prefer the kit with an alternative colour please advise.

Contents

2 x 750ml Cans of Yellow Paint 1 x Chalk Line
1 x 4 Wheel Paint Applicator 1 x Chalk Refill

5 9601

Floor Graphic Frames



Tough permanent adhesive colour edged PVC frames that enable a printed message or barcode to be placed and protected onto the floor.

Manufactured using thin plastic membrane, the frame bonds on the floor surface and are resistant to the rigours of a busy warehouse. Ideal for identifying stock locations or to highlight important information.



Displays an A4 message (not included), simply print off your own message and place in the window. Alternative frame colours available on request.

400 x 310mm frame with a clear A4 (297 x 210mm) window to display your printed message.

Yellow 5 8935
Yellow / Black 5 8936

Pallet Markers

Tough, highly visible yellow floor markers with aggressive adhesive backing for application to clean, flat surfaces. Capable of withstanding everyday traffic in a fully operational warehouse. Perfect to highlight pallet positions, walkways and traffic flow. Other colours available upon request.



10 x Centre Pallet Locators
300 x 300mm
5 9505

10 x Corner Pallet Locators
200 x 200mm
5 9508

100 x Traffic Flow Markers
90 x 90mm
5 9506

10 x Edge Pallet Locators
300 x 200mm
5 9524

100 x Walkway Locators
90mm Diameter
5 9509

10 x Walkway Footprints
300 x 100mm
5 9507

Floor Safety & Demarcation

Retractable Barrier Posts

Use these stylish retractable barrier posts to manage crowds in shops, hotels or anywhere needing an orderly queuing system. Each 1015mm high post comes complete with 3.4m of retractable 50mm wide webbing stored in the head. Simply pull out and attach to additional posts or wall brackets. Includes a belt lock and slow retract braking system for safety purposes. Available in both polished or black powder coated stainless steel.

1015mm high post with 355mm diameter base providing excellent ballast of 9kg. Other standard webbing and post colours along with printed safety message belts are available upon request.

Post / Belt Colour	Red Belt	Blue Belt	Black Belt
Polished Stainless Steel Post	5 9026	5 9027	5 9028
Black Post	5 9043	5 9044	5 9045



Custom Webbing

For custom webbing options please contact us for a quote and specify your message of choice and the colours you wish to use.



Industrial Retractable Barrier Posts

Designed for outdoor use, these retractable posts feature a heavy duty, non-rusting recycled rubber base (480mm dia) and a powder coated stainless steel post (1015mm high) complete with 3.4m of safety chevron webbing (50mm wide) stored in the head. Simply pull out and attach to additional posts or wall brackets. Includes a belt lock and slow retract braking system for safety purposes. Rubber base includes carry handles and post can be removed for ease of handling/storage. Webbing can be supplied with safety messages – please ask for a quote.

1015mm high post with 480mm diameter base providing excellent ballast of 9kg

Belt Colour	Post Colour	Code
Black & Yellow	Yellow	5 9046
Red & White	Red	5 9047



Wall Bracket



This plastic wall bracket is for use with our retractable barrier posts.

Secure the clip at the end of the webbing to this wall bracket to create a barrier.



The plastic bracket is easily fitted to the wall with screws.

5 9035

Retractable Wall Mounted Barrier



50mm wide retractable webbing supplied in a black powder coated steel housing with wall screw fixings and a receiver clip supplied as standard.

Perfect for environments where you want a flexible retractable barrier without taking up any floor space. Longer length belts and printed safety messages are available on request.

Belt Colour	3m	4.6m
Red	5 9020	5 9494
Black	5 9022	5 9495
Red & White	5 8926	5 9493
Black & Yellow	5 8927	5 9492

Sign Frame on a Post



Universal chain post and base with 300 x 250mm sign frame. Supplied complete with your sign of choice.

Please state required message when ordering.

Frame Colour	Post Colour	Code
White	Red & White	5 9631
Yellow	Black & Yellow	5 9632
Red	Red & White	5 9633

Pre-Printed Wall Mounted Barrier Messages

Wall mountable retractable barriers with popular messages printed onto the fabric. A very effective system for restricting access with a choice of belt lengths available.



Chain Posts

Plastic posts and chains offer a lightweight, flexible option for cordoning off areas quickly and easily, making them perfect for temporary hazards such as spillages or for preventing access to areas during cleaning or hazardous work activities. The posts and bases are easily detached for ease of storage.

Universal Chain Post & Base

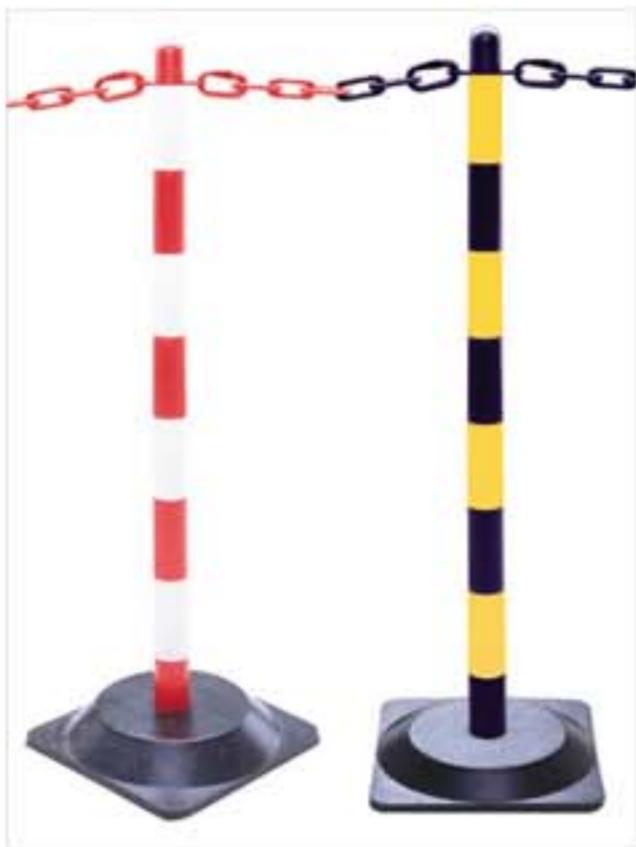

An ideal, low cost solution for cordoning off areas both internally and temporarily in outdoor environments. Quickly and easily deployed.

Use with plastic chains and chain links below (sold separately).

We recommend a maximum of two metres of plastic chain between posts.

- Corrosion proof plastic construction
- Four chain eyes in cap allows easy directional changes
- Highly visible post colours

Base
Hard Rubber Base
Dimensions: 265 x 265mm
Weight: 1.6kg

Post
Corrosion proof plastic
Dimensions: 87 x 4cm (H x Dia)

Colour	Code
Red & White	5 9039
Black & Yellow	5 9040



10m Chain Post Kit

This 10 metre post and chain kit provides exceptional value for money. Allowing areas to be cordoned off quickly and easily.

We recommend a maximum of two metres of plastic chain between posts.

Includes:
6 x Posts and Bases
10 metres of Chain
10 x Hooks and Links

Total Weight: 13kg

Colour	Code
Red & White	5 9036
Black & Yellow	5 9037



Plastic Chain



10 metres of polyethylene chain with 6mm links

Can be easily cut to length if required.

Use the S-hook or Connector Link to attach chains to posts.

Colour	Code
Red & White	5 9041
Black & Yellow	5 9042

Chain Links

Nylon links for connecting chains to posts

S-Hook Link



51 x 30 x 8mm

Colour	Code
Red	5 9018
Black	5 9019

Connector Link



60 x 32 x 8mm

Colour	Code
Red	5 8929
Black	5 8930

Heavy Duty Chain Post & Base

A highly stable and extremely effective heavy duty chain post system consisting of a reflective, polypropylene post and recycled PVC base. Suitable for both internal and external use for either temporary or permanent applications.

100mm diameter post includes a retro-reflective red and white finish, providing excellent visibility when light is shone at it. The chain eye on top of the post rotates, guiding the chain to any angle required. Simply thread the chain through the eye and secure to the end posts with a connector link (sold separately). The post twists and locks into the base and easily dismantles for storage.

We recommend a maximum of 2.5 metres of plastic chain between posts.

Base
Recycled PVC base with carry handles
Dimensions: 7cm high, 57cm diameter
Weight: 8.5kg

Post
Moulded polypropylene with reflective finish and rotating chain eye
Dimensions: 1metre height with 10cm diameter
Weight: 2.7kg

5 8928



PPE Stations

Store and display essential PPE with these stations to help ensure all personnel and visitors have instant access to mandatory safety equipment. Each station includes strong black polypropylene hooks from which to hang the relevant PPE, helping to keep it free from damage. The board is manufactured from 10mm foam pvc which can be easily drilled for wall mounting. Customised versions are available upon request.



10mm Foam
540 x 160mm
5 5982



10mm Foam
540 x 160mm
5 5981



10mm Foam
540 x 160mm
5 5980



10mm Foam
540 x 160mm
5 5979



10mm Foam
80 x 160mm
5 5977



10mm Foam
80 x 160mm
5 5976



10mm Foam
80 x 160mm
5 5978



10mm Foam
80 x 160mm
5 5975

Stations with Hanging Rails

Store tools or equipment in a central location with this range of stations. These stations are supplied with a variety of hanging rails, choose from magnetic rails or a hanging rail with hooks.



380mm Magnetic Rail
10mm Foam
440 x 600mm
5 5970



300mm Magnetic Rail
10mm Foam
440 x 600mm
5 5969



Rail with 5 Hooks
10mm Foam PVC
600 x 440mm
5 5973



Contact us for bespoke solutions - including alternative sizes, branding, colourways or hanging rail configurations.

Cleaning Equipment

Our shadow boards have been designed to include the following equipment. We can produce bespoke shadow boards with any selection of equipment shown below.

Broom Head
Polypropylene & Polyester Fill
285 x 56mm
5 5962



Handle
This universal handle can be used on our mop, broom and squeegee heads



Aluminium with Polypropylene Grip
1195 x 23mm Dia
5 5961

Shovel
Polypropylene shock and crack resistant shovel. Strong, light and easily cleaned.



Polypropylene
320 x 260mm
1150mm Height
5 5965

Dustpan
Polypropylene
330 x 203mm
5 5959



Dustpan Brush
Polypropylene & Polyester Fill
280 x 35mm
5 5960



Squeegee
600mm
Polypropylene Blade
5 5974



Mop Bucket
Polypropylene
285 x 370mm
12 Litre
5 5964



Mop Head
200g Yarn
5 5963



Hanging Equipment

The blue hangers and hooks can be slid into the channelled hanging rail to meet your required configuration.

Medium Hanger
for Hanging Rail
Fits 20-30mm Dia
83 x 86mm
5 5956



Large Hanger
for Hanging Rail
Fits 30-40mm Dia
77 x 86mm
5 5957



Magnetic Rail
300 x 35mm
5 5966



Channelled Hanging Rail
Aluminium with Blue End Cap
515 x 55mm
(Hooks not included)
5 5955

Plastic Hook
for Hanging Rail
55 x 70mm
5 5958



Metal Hook
for Magnetic Rail
20 x 100mm
5 5968



Magnetic Rail
380 x 45mm
5 5967



Equipment Hanging Bracket
Black Polypropylene Plastic
53 x 58 x 78mm
Fix to wall with screws (not included)
5 5933

Shadow Boards

A Shadow Board is a great addition to any 5S / 6S system, acting as a locator for tools and equipment. The shadow board allows the easy recognition of missing items and helps to ensure everything is stored correctly. Each shadow board is marked for accurate attachment of hooks, hangers and rails.

There are many important benefits derived from using a shadow board system such as: **1.** Systematic storage in an organised manner - makes it easy to locate items when needed, **2.** Improved productivity due to the ease of locating required tools, **3.** Accountability - with each area responsible for their workstation, missing items are quickly identified, **4.** Space utilisation is improved by keeping everything stored neatly in one easy to reach location.

All stations on this page are supplied complete with contents listed.

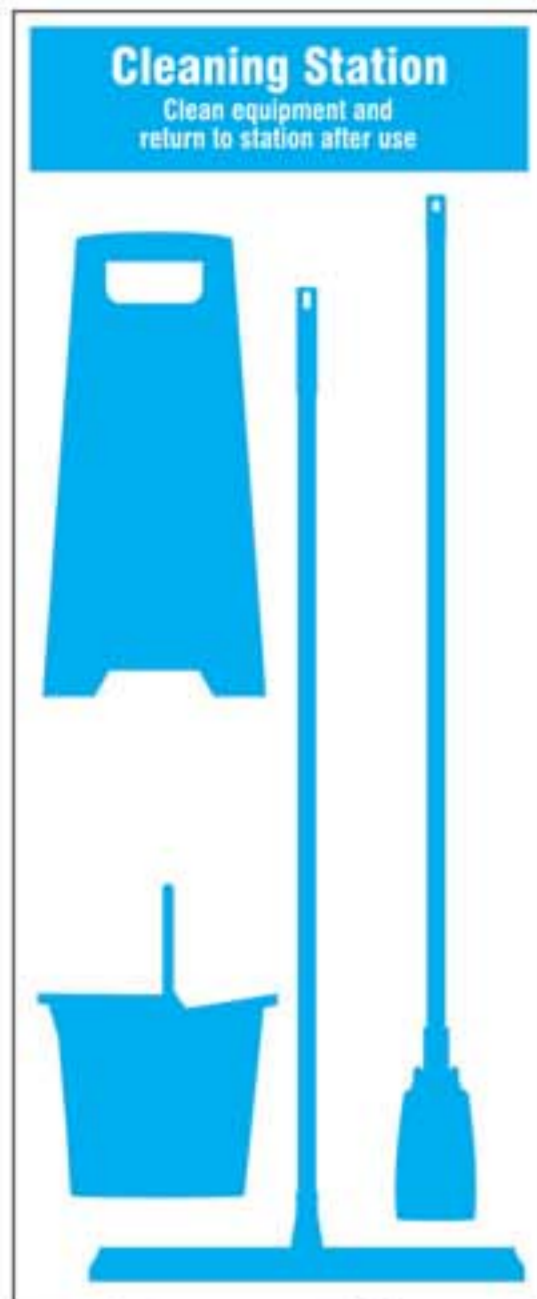

4 Piece Station
10mm Foam
750 x 1800mm
5 5986

- 1 x Mop
- 1 x Squeegee
- 1 x 12L Bucket
- 1 x Wet Floor Sign

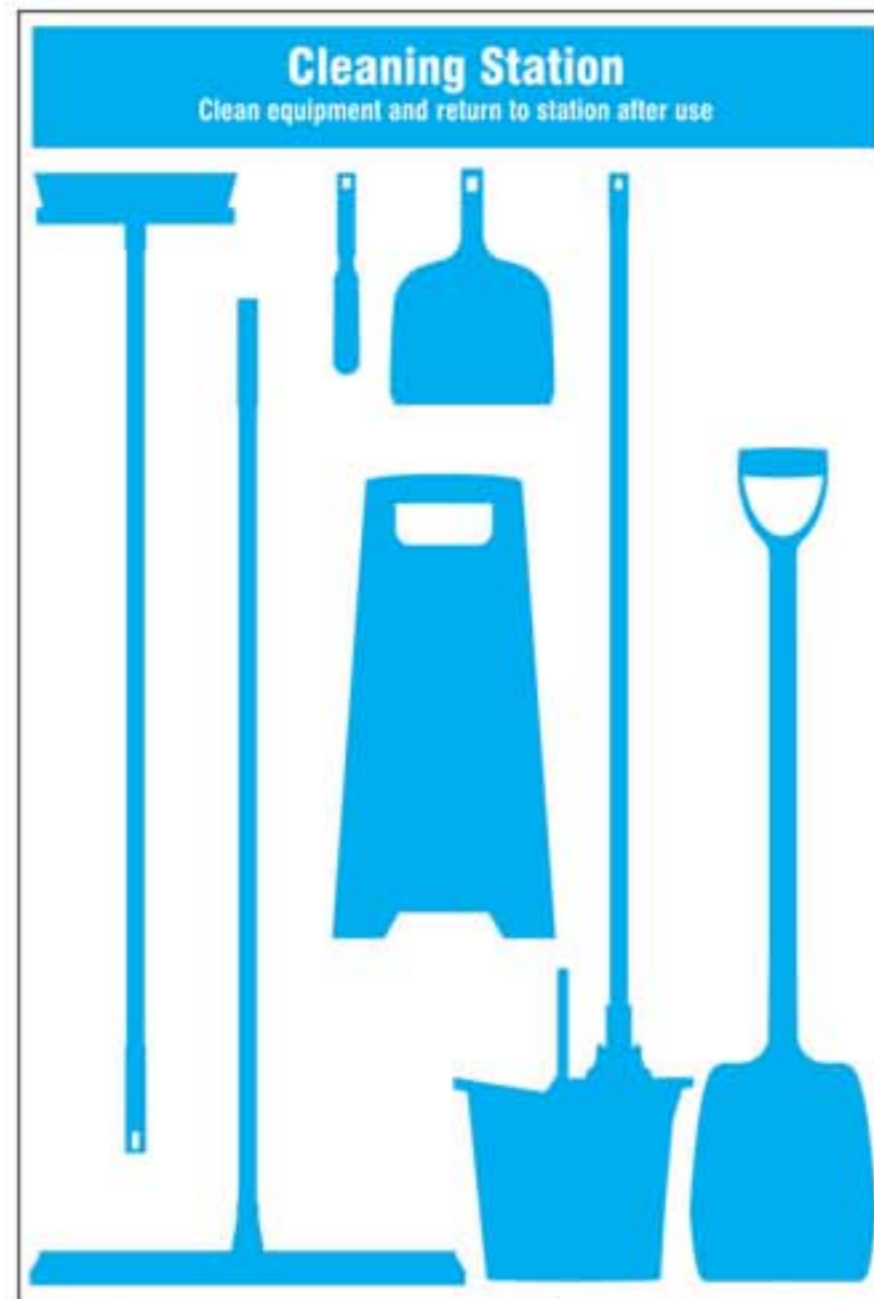

8 Piece Station
10mm Foam
1220 x 1800mm
5 5984

- 1 x Mop
- 1 x Broom
- 1 x Shovel
- 1 x Squeegee
- 1 x Dustpan
- 1 x 12L Bucket
- 1 x Dustpan Brush
- 1 x Wet Floor Sign



5 Piece Station
10mm Foam
600 x 2000mm
5 5972

- 1 x Broom
- 1 x Dustpan
- 1 x Shovel
- 1 x Wet Floor Sign
- 1 x Dustpan Brush



6 Piece Station
10mm Foam
600 x 2000mm
5 5971

- 1 x Mop
- 1 x Broom
- 1 x Dustpan
- 1 x 12L Bucket
- 1 x Wet Floor Sign
- 1 x Dustpan Brush



7 Piece Station
10mm Foam
750 x 2000mm
5 5983

- 1 x Mop
- 1 x Broom
- 1 x Dustpan
- 1 x Squeegee
- 1 x 12L Bucket
- 1 x Wet Floor Sign
- 1 x Dustpan Brush



2 Piece Station
10mm Foam PVC
440 x 600mm
5 5985

- 1 x Dustpan
- 1 x Dustpan Brush



Bespoke Shadow Boards



We can make bespoke shadow boards that include any configuration of our range of cleaning equipment. Both the shadow boards and equipment come in a range of colours. Contact us for more information.

6S Safety Signs

6S is a system for organising spaces so work can be performed efficiently, effectively and safely. This system focuses on putting everything where it belongs and keeping the workplace clean and tidy, which makes it easier for people to do their jobs without wasting time or risking injury.

A neat and tidy workplace will see higher productivity; produce fewer errors/defects; meet deadlines better; be a safer place to work; identify problems earlier; promote stronger communication levels; reduce waste and lower costs. Our range of signs and posters help to promote the importance of 6S.

6S Steps to Safety

6S is a system for organising spaces so work can be performed efficiently, effectively, and safely. This system focuses on putting everything where it belongs and keeping the workplace clean, which makes it easier for people to do their jobs without wasting time or risking injury.

The Steps to Follow:

- 1. SORT**
Go through all the tools, furniture, materials, equipment and instructions in your work area to determine what needs to be present and what can be removed. Keep only the items that are frequently used or of importance. If you are unsure then red tag the item and place it in a red tag holding area until a decision can be made.
- 2. SET IN ORDER**
Consider how the layout and organisation of an area could increase/decrease waiting time, motion and unnecessary transportation. Arrange tools, parts and instructions in such a way that the most frequently used items are the easiest and quickest to locate.
- 3. SWEEP AND SHINE**
Cleaning up your work area, which means sweeping, mopping, dusting, wiping down surfaces, putting tools and materials away etc. In addition to basic cleaning, you should perform regular maintenance on equipment and machinery. Planning for maintenance ahead of time means businesses can catch problems and prevent breakdowns - saving time and money!
- 4. STANDARDISE**
Develop repeatable tasks, create schedules, and set instructions so that activities become routines that everyone can follow using the same methods and ensuring consistency throughout. Good signs such as signs, labels, posters, floor markings, shadow boards and labeling/visual controls can help provide direction and keep things in place.
- 5. SUSTAIN**
Sustain is about making 6S a long-term practice, and just a task. Ideally, 6S will become a part of an organisation's culture. It is important to evaluate and look for continual improvement of the system in place. It is important not to let standards slip and to ensure continuous focus in the culture of the work.
- 6. SAFETY**
By following the rules above, your safety should become a major concern. Establishing rules and identifying hazards can help to further reduce dangers in the workplace. Record near misses and what your 6S programme is meant to prevent.

Rigid Plastic
400 x 600mm
5 5940

6S "Sort" Actions

6S is a system for organising spaces so work can be performed efficiently, effectively, and safely. This system focuses on putting everything where it belongs and keeping the workplace clean, which makes it easier for people to do their jobs without wasting time or risking injury.

SORT

Go through all the tools, furniture, materials, equipment and instructions in your work area to determine what needs to be present and what can be removed. Keep only the items that are frequently used or of importance.

QUESTIONS TO ASK DURING THE "SORT" PHASE:

1. What is the purpose of this item?
2. When was this item last used?
3. How frequently is it used?
4. Who uses it?
5. Does it really need to be here?

IF AN ITEM IS DEEMED UNNECESSARY CONSIDER THE FOLLOWING OPTIONS:

1. Check to see if it would be of use to a different department
2. Recycle / Throw Away / Sell the item
3. Put items into storage until required.

If you are unsure whether to keep the item then red-tag it and place it in a red-tag holding area until a decision can be made.

USE IT OR LOSE IT

Rigid Plastic
400 x 600mm
5 5942

6S "Set in Order" Actions

6S is a system for organising spaces so work can be performed efficiently, effectively, and safely. This system focuses on putting everything where it belongs and keeping the workplace clean, which makes it easier for people to do their jobs without wasting time or risking injury.

SET IN ORDER

Consider how the layout and organisation of an area could increase / decrease waiting time, motion and unnecessary transportation. Arrange tools, parts and instructions in such a way that the most frequently used items are the easiest and quickest to locate.

QUESTIONS TO ASK DURING THE "SET IN ORDER" PHASE:

1. Which people (or workstation) use which items?
2. When and how often are items used?
3. Which items are used most frequently?
4. Is there a benefit in grouping items by type or colour?
5. Where would it be most logical to place items?

CONSIDER EACH OF EACH, REDUCTION OF MOVEMENT & ERGONOMICS FACTORS:

1. Are more storage containers and/or shadow boards necessary to keep things organised?
2. Is it obvious where an item is missing?

A PLACE FOR EVERYTHING AND EVERYTHING IN ITS PLACE

Rigid Plastic
400 x 600mm
5 5941

6S "Sweep & Shine" Actions

6S is a system for organising spaces so work can be performed efficiently, effectively, and safely. This system focuses on putting everything where it belongs and keeping the workplace clean, which makes it easier for people to do their jobs without wasting time or risking injury.

SWEEP AND SHINE

Cleaning up your work area, which means sweeping, mopping, dusting, wiping down surfaces, putting tools and materials away etc. In addition to basic cleaning, you should perform regular maintenance on equipment and machinery. Planning for maintenance ahead of time means businesses can catch problems and prevent breakdowns - saving time and money!

FOR A CLEAN AND SAFE WORKPLACE:

1. Keep aisles clear
2. Immediately clean up spills
3. Make sure tools and equipment are kept clean and oil free
4. Properly and promptly dispose of waste, recycling where appropriate
5. See to it that fire exits are kept clear at all times
6. Smoke only in designated areas and use the provided bins
7. Stack items neatly and safely in defined locations
8. Make sure extinguishers are easily accessible and clearly marked
9. Ensure routine equipment maintenance programmes are put in place and followed accordingly
10. Always return equipment to its dedicated location when work is completed
11. Ensure paperwork is completed and filed at the end of each shift

A CLEANER AND TIDIER WORKPLACE IS A SAFER WORKPLACE

Rigid Plastic
400 x 600mm
5 5943

A place for everything and everything in its place

6S

Rigid Plastic
400 x 600mm
5 5952

Maintain your workstation in a tidy condition

6S

Rigid Plastic
400 x 600mm
5 5953

Keep all areas clean and tidy

6S

Rigid Plastic
400 x 600mm
5 5951

RED TAG

Red Tag Holding Area

6S

Rigid Plastic
400 x 600mm
5 5954

6S Steps to Safety

Keep all areas clean and tidy

1 5945 K

6S Steps to Safety

A place for everything and everything in its place

1 5946 K

6S Steps to Safety

Maintain your workstation in a tidy condition

1 5947 K

RED TAG HOLDING AREA

ONLY ITEMS TO BE CONSIDERED FOR DISPOSAL SHOULD BE PLACED WITHIN THIS HOLDING AREA

- ✓ ALL ITEMS MUST BE CORRECTLY LABELLED WITH A RED-TAG
- ✓ ALL ITEMS WITHIN THIS AREA MUST BE STORED TIDILY AND SAFELY
- ✓ ITEMS WILL BE ROUTINELY REVIEWED AND EVALUATED

1 5944 K P

6S Steps to Safety

Red Tag Holding Area

1 5948 K

6S Steps to Safety

Good house keeping makes our work safer

1 5949 K

6S Steps to Safety

6S supplies stored here

1 5950 K

Double Sided Tags

RED TAG

Date: _____ Issued to: _____
 Item Name: _____
 Location: _____
 Category: _____
 Equipment Machine Parts
 Tools & Jigs Raw Materials
 Finished Goods Components
 Work in Progress Customer Kit
 Consumables Other: _____
 Other: _____
 Reason: _____
 Scrap Sell - Quantity: _____
 Not Recycled Extra: _____
 Other: _____
 Additional Information or Remarks: _____

RED TAG

Action to Take: _____
 Return to _____
 Move to Red Tag Holding Area
 Store in _____
 Other Recycle
 Other: _____
 Additional Comments: _____

Pack of 10 Matt PVC Tags
Supplied with 150mm Cable Ties
80 x 150mm
5 5939

Quality Control Signs, Labels & Tags

Quality control is a process through which a business seeks to ensure that product / work quality is maintained or improved. For our full range of quality control signs see page 61.



Spill Kit Station Signs

Regulation 13 of the Control Of Substances Hazardous to Health Regulations 2002 places a duty on employers to provide for appropriate emergency response including immediate remedial action. EN ISO 14001 requires organisations to "establish and maintain procedures to identify potential for and respond to accidents and emergency situations, and for preventing and mitigating the environmental impact that may be associated with them" (Clause 4.4.7).

Our range of signs inform how to effectively respond to any oil, chemical or general fluid spill on site, inline with EU guidelines and legislation to assist with ISO 14001 compliance.

✓ Spill kit station



1 Protect

a. Evacuate non-essential personnel
b. Assess the spill and identify the liquid
c. Choose the appropriate protective clothing and safety equipment to respond safely



2 Confine

a. Confine the liquid with absorbent booms or socks
b. Overlap the ends of the socks by several inches to prevent any liquid from breaking through



3 Clean up

a. Clean up the spill with pillows, mats or loose absorbents
b. Place the absorbents starting from the outside of the spill working inward



4 Dispose

a. Place saturated absorbents in the provided yellow temporary disposal bags and close with plastic ties
b. Dispose of properly

1 6000 W

Spill kit station

1 6048 H
2 6048 H

Emergency spill response equipment

1 6049 H
2 6049 H

Drain isolation kit

Use this kit to prevent spills entering the local drains

1 6046 H
2 6046 H

Spill Kit

Aggressive fluids (Hazchem)

- ✓ Best for use on aggressive fluids (acids and alkalis)
- ✓ Can be used on non-aggressive fluids
- ✓ Can be used on hydrocarbons (oil and fuels) on land
- ✗ Do not use on hydrocarbons (oil and fuels) on water
- ! Wear approved personal protective equipment

1 6040 H
2 6040 H

Spill Kit

Non-aggressive fluids

- ✓ Best for use on non-aggressive fluids
- ✓ Can be used on hydrocarbons (oil and fuels) on land
- ✗ Do not use on aggressive fluids (acids and alkalis)
- ✗ Do not use on hydrocarbons (oil and fuels) on water
- ! Wear approved personal protective equipment

1 6041 H
2 6041 H

Spill Kit

Oil only

- ✓ Best for use on hydrocarbons (oil and fuels) on water
- ✓ Can be used on all spills on land
- ✗ Do not use on aqueous (water based) fluids
- ✗ Do not use on aggressive fluids (acid and alkalis)
- ! Wear approved personal protective equipment

1 6042 H
2 6042 H

Spill Kit

For Emergency Spill Team Only

- ✓ For emergency spill only
- ✗ Not for general use
- ! In event of emergency spill to raise the alarm contact

1 6043 H
2 6043 H

Spill Kit

For Emergency Spill Team Only

- ✓ For emergency spill only
- ✗ Not for general use
- ! In event of emergency spill to raise the alarm contact

1 6043 H
2 6043 H

Emergency Oil spill kit

1 6031 H
2 6031 H

Emergency Chemical spill kit

1 6033 H
2 6033 H

Spill kit located at:

1 6032 H
2 6032 H

Emergency spill kit

1 6030 H
2 6030 H
8 6030 H

Spill Protective Equipment

This equipment only to be used in the event of a spill emergency. Take the equipment with you to the spill muster point. Raise the alarm and then follow the spill response instructions given to you by the incident controller.

1 6044 H
2 6044 H

Barrier Tapes

Non-adhesive barrier tape, ideal for cornering off hazardous areas

CAUTION HAZARDOUS AREA

Non-Adhesive Polythene
75mm x 250m
5 8624

CAUTION DO NOT ENTER

Non-Adhesive Polythene
70mm x 500m
5 8621

Non-Adhesive Polythene
75mm x 250m
5 8634

Projecting Signs

Identify important locations from several view points with our projecting signs. The fixings are concealed for a neat finish.

Rigid Plastic
150 x 200mm

Spill Station

5 6092

Safety data sheets

5 4300

Battery charging area

5 4301

Emergency Eye wash

5 6088

Emergency shower

5 6086



Document Holder



Keep important documents clearly displayed and readily available in a central location.

Durable clear polystyrene document holder, pre-drilled for easy wall mounting using the screw fixing kit supplied.

Perfect for storing A4 ring binders.

380x180x105mm (W x H x D)
5 9899

Document Holding Signs

440 x 600mm - 10mm Foam Board

Keep important documents clearly displayed and readily available in a central location. Help keep staff informed and up to date with all information relating to safety.

These document holders come with a clear polystyrene holder perfect for storing A4 ring binders and other A4 folders.

COSHH Safety Documents

5 8214

Material Safety Data sheets

5 8215

Hazardous Substance Warnings

Suppliers of dangerous goods are required by law to label their products with hazard symbols and safety advice. GHS symbols have been developed so that people handling hazardous goods know the nature of the hazard they present. For our full range of Hazard Warning Labels and Posters see pages 98-101.



Recycling Signs

An extensive range of recycling signage to ensure your workplace identifies bins and areas dedicated to your recycling programme. Waste & Resources Action Programme compliant.

The aim of the WRAP programme is to help businesses, local authorities, community groups and individuals recycle and reuse more, and to reduce food waste. If you can't find the sign you need for your businesses' recycling programme let us know and we will be happy to quote for custom designs.



1 6673 HQ 2 6673 H 1 6674 HQ 2 6674 H 1 6675 HQ 2 6675 H 1 6676 HQ 2 6676 H 1 6677 HQ 2 6677 H



1 6634 M 2 6634 G 1 6651 M 2 6651 G 1 6631 M 2 6631 G 1 6646 M 2 6646 G



1 6635 M 2 6635 G 1 6652 M 2 6652 G 1 6632 M 2 6632 G 1 6647 M 2 6647 G



1 6636 M 2 6636 G 1 6653 M 2 6653 G 1 6661 M 2 6661 G 1 6649 M 2 6649 G



1 6659 M 2 6659 G 1 6654 M 2 6654 G 1 6664 M 2 6664 G 1 6650 M 2 6650 G



1 6658 M 2 6658 G 1 6660 M 2 6660 G 1 6662 M 2 6662 G 1 6645 M 2 6645 G



1 6657 M 2 6657 G 1 6644 M 2 6644 G 1 6663 M 2 6663 G 1 6639 M 2 6639 G



1 6640 M 2 6640 G 1 6638 M 2 6638 G 1 6641 M 2 6641 G 1 6637 M 2 6637 G



1 6617 H 2 6617 AH 1 6619 H 2 6619 AH 1 6624 H 2 6624 AH 1 6625 H 2 6625 AH 1 6618 H 2 6618 AH 1 6623 H 2 6623 AH 1 6611 M



A pack of four double sided adhesive foam tabs. Suitable for indoor use. 5 8724

For our full range of recyclable, PVC-free, eco-friendly signage see pages 90-91.



Recycling and Waste

 1 6602 KQ	 1 6607 KQ	 1 6601 KQ
 1 6608 KQ	 1 6610 KQ	 1 6606 KQ
 1 6604 KQ	 1 6609 KQ	 1 6605 KQ

Bespoke Boards

We can create custom signs for site specific recycling programmes.

These boards can include company details, logos, images, include text and advise of a wide range of recyclable materials accepted on your site.

Please supply artwork or provide details of your required design and ask us for a quote.

We are able to manufacture on a wide range of materials (including eco-friendly) and sizes to suit your preference and budget.



Aluminium Roll Top

These highly durable signs are designed to neatly hook over scaffolding and railings. Aluminium - 600 x 400mm

 5 6602	 5 6601	 5 6604	 5 6666
---	---	--	---

Custom Roll Top

Create your very own roll top with a custom message



5 6386

Disposal / Littering

 1 1773 KQ 2 1773 E	 1 5492 KQ 2 5492 E	 1 1772 EK 2 1772 EK	 1 3629 A 2 3629 A	 1 1743 KQ 6 1743 K
 1 5494 KQ	 1 5493 KQ	 1 5495 KQ 2 5495 E	 1 4518 GM 2 4518 GM	 1 5640 GM 2 5640 GM

Energy Saving Signs

 2 6036 A 8 6036 A	 1 6628 A 2 6628 A	 1 6629 A 2 6629 A	 1 6622 A 2 6622 A	 1 6621 A 2 6621 A 8 6621 A	 1 6620 A 2 6620 A 8 6620 A
---	---	---	--	--	--



Material Codes

1 Rigid Plastic 5 Miscellaneous 8 Quick Fix
2 Self Adhesive Vinyl 6 Aluminium

Landscape Sizes

G 300 x 100mm **M** 600 x 200mm
K 400 x 300mm **Q** 600 x 450mm

Portrait Sizes

A 75 x 100mm **H** 250 x 300mm **Q** 450 x 600mm
E 150 x 200mm **K** 300 x 400mm

Door Screen Signs



Door Screen Safety Signs offer an innovative solution to warn people of potential hazards and prevent access by fitting a barrier with the appropriate message across a doorway.

- 600 x 450mm flexible PVC sign
- Rubber end caps for maximum grip
- Wipes clean and rolls away for easy storage
- Spring loaded poles (710 to 1010mm to fit most single doorways)
- Warning message prevents access and warns of hazards
- An excellent temporary barrier to prevent access during cleaning or repairs.



Cover up Signs

The Cover-Up Sign provides a clear barrier to faulty equipment such as toilets, vending machines and office equipment. A clear visual message warns of the fault whilst the sign itself provides a physical barrier. Assembled in seconds, using hook and loop fixings. Simply collapse the Cover-Up sign when it is no longer required and store until the next use.

- Floor or wall mounted, wipe-clean material
- Collapsible and reusable for easy storage
- Provides a clear message and physical barrier
- Strong, lightweight and waterproof
- Offers a professional looking solution for short-term maintenance issues

880 x 430 x 350mm
Fluted Polypropylene
Supplied with suction cups for wall fixing



Lightweight Free-Standing Signs

300 x 600mm - Fluted Polypropylene - Perfect for identifying areas contaminated by a spill.



Free-Standing Signs

300 x 575mm - Polypropylene - Provide a clear and appropriate warning of risks with our yellow self standing signs.



Up to 10 words on both sides



Private Land and Farming Signs

Did you know that farming is statistically the most dangerous industry in the UK? Using the right farm safety signs is necessary to meet legal requirements and protect the landowner from liability if someone is injured on their property, so it's vital to properly display farm signs where required.

 1 5506 K	 1 5508 K	 1 5510 K	 1 5511 K	 1 5512 K	 1 5507 K
 1 5515 K	 1 5516 K	 1 5517 K	 1 5513 K	 1 5514 K	 1 5509 K
 1 7590 Q	 1 5518 Q	 1 7685 Q	 1 5519 Q		
 1 5520 Q	 1 5521 Q	 1 5522 Q	 1 5523 Q		
 1 5531 QW	 1 5524 Q	 1 5525 Q	 1 5526 Q		
 1 5527 Q	 1 5529 Q	 1 5528 Q	 1 5530 Q		



Tractor Inspections

The most common causes of serious and fatal injuries in agriculture involve farm vehicles and machinery. To comply with legislation, you should carry out daily checks to make sure the machinery you are about to use, or allow someone else to use, is safe and working correctly. Keeping a record of when an inspection has been carried out is important, they can help show that a tractor is well maintained and regularly checked, proving invaluable in the event of an HSE inspection following an accident. See page 131 - 135 for more information.

Security Signs

 <p>Warning Anti climb paint</p> <p>1 1714 GM 2 1714 GM 7 1714 GM 8 1714 G</p>	 <p>Warning Barbed wire</p> <p>1 1720 GM 2 1720 G 7 1720 GM</p>	 <p>Warning Razor wire</p> <p>1 1715 GM 2 1715 G 7 1715 GM</p>	 <p>Warning Electric fence</p> <p>1 4023 GM 2 4023 G</p>				
 <p>Caution Security alarm will sound if door is opened</p> <p>1 1738 G 2 1738 G</p>	 <p>Warning Guard dogs on patrol</p> <p>Keep out</p> <p>1 6215 GMP</p>	 <p>Exit for emergency use only</p> <p>Caution This door is alarmed</p> <p>1 2065 GL 2 2065 GL</p>	 <p>Fire exit only</p> <p>Caution This door is alarmed</p> <p>1 2061 GL 2 2061 GL</p>				
 <p>Warning This property is patrolled by security guards</p> <p>1 1730 HK</p>	 <p>Warning This is a security patrolled area</p> <p>1 1727 HK</p>	 <p>Warning This door is alarmed</p> <p>1 4220 F 2 4220 F</p>	 <p>Warning These doors are alarmed</p> <p>1 1706 FU 2 1706 FU</p>	 <p>Warning These doors are alarmed</p> <p>1 1707 FU 2 1707 FU</p>	 <p>Warning Trespassers will be prosecuted</p> <p>1 1731 HK</p>	 <p>Warning These premises are alarmed</p> <p>1 1702 OH 2 1702 OH</p>	 <p>Warning This is a restricted area</p> <p>1 1728 HK 2 1728 H</p>
<p>Adhesive Tabs Pack of 4 - 10 x 25mm 5 8724</p>							

Vehicles & Equipment

 <p>Warning All vehicles entering or leaving these premises are liable to be searched</p> <p>1 7530 C</p>	 <p>THIS IS A NO DRONE ZONE Unauthorised use of drones in this area is strictly prohibited OFFENDERS ARE LIABLE FOR PROSECUTION If you see someone preparing to fly or flying a drone, report it immediately to:</p> <p>1 3676 KQ 2 3676 KQ</p>	 <p>Warning This vehicle is fitted with a tracker</p> <p>2 1826 E</p>	 <p>No Drones Use of drones and UAVs over this site is strictly prohibited. Anyone found operating a drone over this location will be reported for prosecution and subject to civil legal action</p> <p>1 3649 KQ</p>
 <p>Warning No tools stored in this vehicle overnight</p> <p>2 1723 E</p>	 <p>Warning Cars parked here without authorisation will be clamped Release fee £....</p> <p>1 7533 M</p>	 <p>Warning Cars parked here without authorisation will be clamped Release fee £50.</p> <p>1 7539 MP</p>	 <p>Caution Drones may be operating in this area</p> <p>1 4067 KQ</p>
 <p>Warning Cars parked here without authorisation will be clamped</p> <p>1 7532 MP</p>	 <p>Warning No wireless, electronic or recording devices allowed beyond this point</p> <p>1 3671 GM 2 3671 GM</p>	 <p>Warning No electronic devices allowed beyond this point</p> <p>1 5475 K 2 5475 K</p>	

Terrorism Signs

This range offers clear, succinct, jargon-free guidance about security standards and procedures.

 <p>Stay Safe Suspicious Items Don't touch it, keep a safe distance and report it to a member of staff</p> <p>1 1744 HP 2 1744 HP</p>	 <p>STAY SAFE Suspicious Items Do not touch Try and identify an owner in the immediate vicinity If you still think it's suspicious, don't feel embarrassed, tell someone you trust Report it to a member of staff, security, etc. If they are not available, dial 999 Move away to a safe distance Remember - if you think it's suspicious, SAY SOMETHING</p> <p>1 1745 HP 2 1745 HP</p>
 <p>STAY SAFE Terrorist Firearms and Weapons Attacks RUN To a place of safety. This is a better option than to surrender or negotiate. If there's nowhere to go, then... HIDE Remember to turn your phone on silent and turn off alerts. Barred yourself in if you can. TELL The police by calling 999 when it is safe to do so. TREAT Assess and treat the injured or vulnerable when it is safe to do so.</p> <p>1 1746 HP 2 1746 HP</p>	

Property

 <p>Private driveway No parking or turning</p> <p>1 6590 GM</p>	 <p>This is private property The entry of unauthorised persons is prohibited</p> <p>1 6433 Q</p>	 <p>PRIVATE No public right of way</p> <p>1 7685 Q</p>	 <p>Notice Please ensure this gate is closed and latched at all times Thank you</p> <p>1 7125 H</p>
 <p>Private</p> <p>1 7014 GL 2 7014 G</p>	 <p>Notice Private property Keep out</p> <p>1 7003 K</p>	 <p>Notice Trespassers will be prosecuted</p> <p>1 7006 K</p>	 <p>Thieves will be prosecuted</p> <p>1 1703 K</p>
 <p>SECURITY NOTICE These premises are under constant surveillance</p> <p>1 1704 K 2 1704 K</p>			

Bespoke Security Signs

If you require one of these signs in a different size, material or including company branding or colourways contact us today for a quote!



CCTV Safety Signs

If your business uses CCTV, you must inform people that they could be recorded. This is usually done by displaying signs, which must be clearly visible and readable. In order to comply with the Data Protection Act 1998, signs must state the purpose of the scheme, and give details of the Data Protection Act Controller (either the person's name or position, or preferably the company's name) together with a contact telephone number or address, if it is not obvious.



1 1700 **HK**
2 1700 **HK**
8 1700 **H**



1 1747 **HKP**
2 1747 **HKP**
8 1747 **H**



1 1712 **HK**
2 1712 **HK**
7 1712 **HK**
8 1712 **H**



1 1711 **HK**
2 1711 **HK**



1 1721 **HK**
2 1721 **HK**
6 1721 **HK**
7 1721 **HK**
8 1721 **H**





1 1739 **HK**
2 1739 **H**



1 1740 **HK**
2 1740 **HK**



1 1710 **HK**
2 1710 **H**



1 1748 **HKP**
2 1748 **HKP**
8 1748 **H**



1 1713 **HK**
2 1713 **H**
8 1713 **H**



1 1719 **H**
2 1719 **H**

Window Labels 75 x 100mm - Face Adhesive Vinyl

Adhesive on the face, allowing them to be applied to the inside of the window and viewed from outside



5 1729



5 1702



5 1730



5 9790



5 9791



5 9792



Security Eyes

Research indicates that the feeling of being watched can influence peoples' behaviour, leading to a reduction in crime. Use alongside our standard signs to reinforce security and safety messages.



1 1750 **DGJMX**



1 1751 **DGJMX**



1 1752 **DGJMX**

Contractor Pass

Maintain a register of authorised contractors on site for use in case of emergency or for record tracking / invoice verification.

Record the authorised Work Location and Type of Work to be undertaken.

9 pages of 12 passes (108 total)
Size: 412mm x 280mm
Pass size: 103mm x 84.5mm

5 7130



Key Control System

A simple paper based key control system to control the allocation of keys.

Keep a record of all key distributions and returns to and from authorised keepers or visitors/contractors

Easily see which keys have been given out by using the tear off notice to keep in absence of a key

Comes with 100 tear off NCR Key Slips

5 7131



Visitor Management

Organise, record and identify visitors in your premises with this range of products.

The visitor book has perforated top copies which tear off for insertion into badge wallets with a duplicate copy retained for a permanent visitor record. Starter kit includes a synthetic leather padded folder, visitor book with 300 badge inserts and 10 badge wallets with clips.



Visitor Starter Kit 5 6071
Visitor Book Refills (300) 5 6072



Pack of 10 Badge wallets 5 6073



1 5444 **E**
2 5444 **E**

Material Codes

- 1 Rigid Plastic
- 2 Self Adhesive Vinyl
- 5 Miscellaneous
- 6 Aluminium
- 7 PET
- 8 Quick Fix

Landscape Sizes

- D** 150 x 100mm
- E** 200 x 150mm
- F** 200 x 200mm

- G** 300 x 100mm
- H** 300 x 250mm
- J** 400 x 200mm

- K** 400 x 300mm
- L** 450 x 150mm
- M** 600 x 200mm

- P** 600 x 400mm
- Q** 600 x 450mm
- U** 100 x 100mm

X 200 x 100mm

Portrait Sizes

- D** 100 x 150mm
- E** 150 x 200mm
- H** 250 x 300mm

- K** 300 x 400mm
- P** 400 x 600mm
- Q** 450 x 600mm

Room Signs



1 7081 **G**
2 7081 **G**



1 7017 **GL**
2 7017 **GL**



1 7014 **GL**
2 7014 **G**



1 7020 **G**
2 7020 **G**



1 7015 **GL**
2 7015 **GL**



1 7010 **GL**
2 7010 **GL**



1 7033 **G**
2 7033 **G**

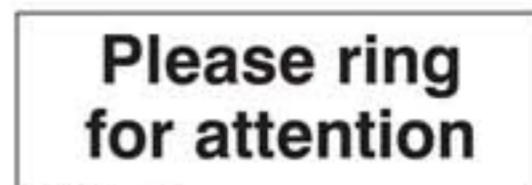

1 7013 **GL**
2 7013 **G**



1 6425 **G**
2 6425 **G**



1 7579 **GM**



1 7021 **GL**
2 7021 **GL**



1 7046 **GL**
2 7046 **GL**



1 7011 **GL**
2 7011 **GL**



1 7074 **GL**
2 7074 **G**



1 7070 **GL**
2 7070 **G**



1 7018 **GL**
2 7018 **GL**



1 6408 **GM**
2 6408 **GM**
7 6408 **G**
8 6408 **G**

Suspended Sign Frames

These are perfect solution for way finding signs and can be used either single or double sided. All our suspended frames are supplied with a hanging kit.

Colour	300x100mm	450x150mm
Grey	5 8681	5 8680
White	5 8700	5 8701
Green	5 8703	5 8704



Gate / Door Signs



2 7071 **AE**



2 7072 **AE**



1 7028 **A**
2 7028 **AE**
8 7028 **A**



1 7029 **A**
2 7029 **AE**
8 7029 **A**

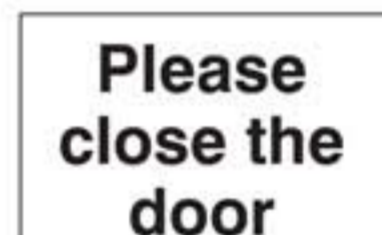

1 7042 **D**
2 7042 **D**



1 7001 **K**

Custom Signs

We can produce digitally printed specials to include graphics, fonts, photography and colour to suit your needs.

Simply provide us with the relevant artwork and we can deliver in a range of materials and sizes.

See page 148 for information.



Adhesive Pads

For quick installation of rigid plastic signs.

Self Adhesive Tabs
10 x 25mm
Pack of 4
5 8724

More fixing options available on pages 136 - 137.



Double Sided Window Stickers

Apply to the inside of a glass window or door so the appropriate message can be seen from both sides.

The image to the back has the self adhesive face for applying to the glass.

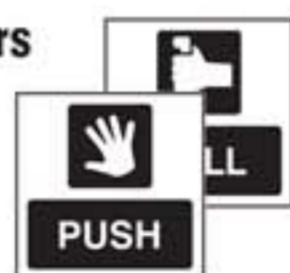

150 x 150mm
5 8252

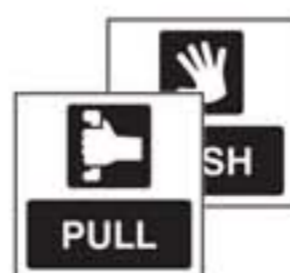

150 x 150mm
5 8257



150 x 150mm
5 8254



150 x 150mm
5 8253

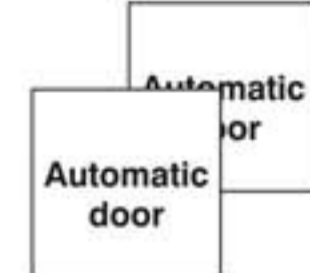

150 x 150mm
5 8250



150 x 220mm
5 8251



















300 x 100mm
5 9544





300 x 100mm
5 8255











Toilet Signs

 1 7043 C 2 7043 C	 1 7007 GL 2 7007 GL 8 7007 G	 1 7061 G 2 7061 G 7 7061 GM 8 7061 G	 1 7080 G 2 7080 G
 1 7024 DF 2 7024 DF	 1 7009 GL 2 7009 GL 8 7009 G	 1 7057 G 2 7057 G	 1 7087 G 2 7087 G
 1 7025 DF 2 7025 DF	 1 7008 GL 2 7008 GL 8 7008 G	 1 7058 G 2 7058 G	 1 7086 G 2 7086 G
 1 7093 DF 2 7093 DF	 1 7094 GL 2 7094 GL	 1 7053 GL 2 7053 G 7 7053 GL	 1 7051 GL 2 7051 G 7 7051 GL

Projecting Signs
Use projecting signs for quick identification of toilets from multiple viewing points. Supplied with drilling guide for a quick and simple installation.

 Rigid Plastic 150 x 200mm 5 7024
 Rigid Plastic 150 x 200mm 5 7025
 Rigid Plastic 150 x 200mm 5 7043

 1 7048 F 2 7048 F	 1 7052 F 2 7052 F	 1 7022 F 2 7022 F	 1 7026 F 2 7026 F	 1 7076 V 2 7076 V	 1 7077 V 2 7077 V	 1 7027 F 2 7027 F	 1 7054 F 2 7054 F	 1 7095 E 2 7095 E
---	---	---	---	--	---	---	---	---

Custom Acrylic
Add a contemporary feel to your business with our stand-off acrylic signs.



More information on page 93.

Deluxe Toilet Signs 76mm Dia - Pre-drilled - Fixings Included
Stand out from the crowd. Perfect for high profile establishments.



Aluminium | Stainless Steel 5 9137 | 5 9134
Aluminium | Stainless Steel 5 9138 | 5 9135
Aluminium | Stainless Steel 5 9139 | 5 9136

Anodised Aluminium 140 x 140mm 5 9053
Brass 140 x 140mm 5 9052





Show a commitment to equality in the workplace with inclusive toilet signs

 1 7065 **E**
2 7065 **E**
 1 7096 **E**
2 7096 **E**

Bathroom Notices

 1 6007 A 2 6007 A	 1 6622 A 2 6622 A	 1 3629 A 2 3629 A	 1 5487 GE 2 5487 GE	 1 4288 A 2 4288 A	 1 4286 A 2 4286 A	 1 4236 GA 2 4236 GAK 8 4236 GA
---	---	---	--	---	---	--

Labels Sheet of 6 Self Adhesive Labels - 65mm Diameter.

 Caution Hot water 5 6098	 Not drinking water 5 6099	 Drinking water 5 6094	 Wash your hands 5 1654
---	--	--	--

 1 5424 **G**
2 5424 **G**

 1 5229 **A**
2 5229 **A**

 1 5430 **K**
2 5430 **K**

 1 5436 **K**
Adapt-a-Sign 215 x 310mm 5 5436

Shops, Hotels, Bars and Restaurants

Polite Notice



Please do not take drinks outside

Thank you

1 7108 H
2 7108 H

Polite Notice



The use, possession or distribution of drugs or any illegal substance on these premises is strictly forbidden.

Anyone caught will be banned from these premises and reported to the police.

Thank you

1 7107 H
2 7107 H

Public Notice



Abusive language or threatening behaviour towards our staff will not be tolerated. If you are deemed to be behaving inappropriately you will be asked to leave the premises and reported to the police

Thank you

1 7112 H
2 7112 H

Polite Notice



Please keep quiet when leaving these premises and avoid disturbing local residents

Thank you

1 7105 H
2 7105 H

we reserve the **RIGHT TO refuse the sale** of corrosive substances

NO ID NO SALE If you look under 25 you may be asked to prove you're over the age of 18 when buying products containing corrosive substances

Identifications include:



What is a corrosive substance?

Substances that can damage skin tissues when they come in contact with them.

Applies to any product displaying this symbol on their packaging

1 7120 H
2 7120 H

UNDER 25 No proof of age? **No alcohol**

NO ID NO SALE If you look under 25 you may be asked to prove you're over the age of 18 when buying alcohol

Accepted forms of identification include:



Drunken & Unacceptable Behaviour

Staff will refuse to serve persons they suspect to be drunk, or to serve persons attempting to purchase alcohol for persons they suspect are drunk or under age

1 7109 H
2 7109 H

CHALLENGE 25 Age Verification Policy

If you look under 25, you may be asked to prove you are over 18 when buying alcohol

Weights & Measures Act



Accepted forms of identification include:



1 7110 H
2 7110 H

CHALLENGE 25 Age Verification Policy

If you look under 25, you may be asked to prove you are over 18 when buying alcohol

Weights & Measures Act



Accepted forms of identification include:



1 7111 H
2 7111 H



Employees found to be under the influence of alcohol or illicit drugs will be sent home and face disciplinary action

1 7121 KQ
2 7121 KQ

NOTICE

This is private property. Antisocial behaviour is being targeted and all incidents will be reported to the police.



1 7113 KQ
2 7113 KQ



High-caffeine

We restrict the sale of selected high-caffeine drinks to customers aged 16 or over only.

Customers wishing to buy these products will be asked to show appropriate identification.

1 7122 EH
2 7122 EH



Entry is prohibited to anyone suspected of being under the influence of alcohol

1 7114 GE
2 7114 GE



We reserve the right to refuse entry to anyone suspected of being under the influence of alcohol

1 7115 GE
2 7115 GE



Sssh! Others may be sleeping

2 7621 A

Bath & Hand Towels

Dear Guest Can you imagine how many tons of towels are unnecessarily washed every day in all the hotels all over the world and the enormous amount of washing powder used which can pollute our rivers and seas?

Towels placed into bath or shower. Please help for the sake of our environment

2 7626 A



Caution Hot rail

1 4286 A
2 4286 A



Caution Floor slippery when wet

1 4287 A
2 4287 A

Hanger Signs 440 Micron Matt - 80 x 205mm



5 5107 5 5104 5 5105 5 5106 Double Sided CV0032 Double Sided

Allergy Warnings

Since December 2014 restaurants and food outlets have been required to display details of possible allergens contained in menu items being served.



Caution Allergy Warning

This product contains allergens

<input type="checkbox"/> Egg	<input type="checkbox"/> Mustard
<input type="checkbox"/> Fish	<input type="checkbox"/> Sesame
<input type="checkbox"/> Peanuts	<input type="checkbox"/> Lupin
<input type="checkbox"/> Soybeans	<input type="checkbox"/> Sulphur Dioxide
<input type="checkbox"/> Milk	<input type="checkbox"/> Crustaceans
<input type="checkbox"/> Nuts	<input type="checkbox"/> Molluscs
<input type="checkbox"/> Cereals containing gluten	<input type="checkbox"/> Celery and celeriac

2 5631 B

Food Allergy? Ask before you eat...

Below are some of the foods people may be allergic to and information on where they may be found:

Peanuts	Eggs	Fish
Milk	Cereals (Gluten)	Sulphur Dioxide
Wheat	Soybeans	Crustaceans
Celery	Sesame	Molluscs
Lupin	Sesame Seeds	Mustard
Mustard	Crustaceans	Molluscs

Ask a member of staff about the ingredients in your meal before placing your order. Thank you.

Synthetic Paper 420 x 594mm 5 5641

Food Allergy? Ask before you eat...

Management advises that food prepared here may contain or have come in contact with peanuts, tree nuts, soybeans, milk, eggs, wheat, shellfish or fish

Please ask a member of staff about the ingredients in your meal before placing your order. Thank you

1 5632 K
2 5632 K



Catering and Kitchen Signs

For our full range of catering safety signs see page 40 or contact us for a quote on a bespoke sign.

Table Cards Pack of 5 - Double Sided - 150 x 50mm - Rigid Plastic



5 5633

Workplaces

Polite Notice

Printer Do's & Don'ts

Do	Don't
Add paper when empty	Don't leave coloured or special paper in the tray
Add toner when empty	Don't use printer for personal use
Recycle unwanted copies	Be afraid to ask for help
Only take your printout	

1 5630 **H**
2 5630 **H**

Polite Notice

Copier Do's & Don'ts

Do	Don't
Reset copier settings	Pick up someone else's copies
Recycle unwanted copies	Leave originals behind
Restock paper if needed	Use the photocopier for personal use
Replace toner if needed	Be afraid to ask for help

1 5629 **H**
2 5629 **H**

Polite Notice

Fridge Do's & Don'ts

Do	Don't
Clean up leaks and spills	Leave food uncovered
Check that the door is closed completely	Adjust the temperature
Label and store items in appropriate containers	Move or take items that are not yours
Throw away spoiled food	Keep items past their 'use by date'

1 5623 **H**
2 5623 **H**

Polite Notice

Microwave Do's & Don'ts

Do	Don't
Clean up any messes or spills you have made	Take out someone else's food whilst it's cooking
Reset the controls when you are finished	Leave your food unattended while cooking
Cover all items	Fail to let the appropriate person know if it is broken or faulty
Remove any metal or foil	

1 5624 **H**
2 5624 **H**

ZERO TOLERANCE POLICY

WE DO NOT TOLERATE ANY FORM OF

SEXUAL HARASSMENT RACISM OR AGGRESSION

Failure to comply with this policy may result in disciplinary action.

1 7116 **KQ**
2 7116 **KQ**

ZERO TOLERANCE POLICY

WE'RE WORKING TO END ALL FORMS OF

GENDER-BASED VIOLENCE HARASSMENT ABUSE AND EXPLOITATION

IF YOU NOTICE ANY SUCH BEHAVIOUR PLEASE INFORM A MEMBER OF STAFF

Failure to comply with this policy may result in disciplinary action.

1 7117 **KQ**
2 7117 **KQ**

ZERO TOLERANCE POLICY

THIS COMPANY BELIEVES IN:

EQUALITY DIVERSITY INCLUSION

Failure to comply with this policy may result in disciplinary action.

1 7118 **KQ**
2 7118 **KQ**

ZERO TOLERANCE POLICY

WE WILL NOT TOLERATE ANY FORMS OF

SEXUAL HARASSMENT AGGRESSION RACISM, MISOGYNY LGBT-PHOBIA RELIGIOUS BIGOTRY

If you see, hear or experience any unwanted attention, harassment, contact, bullying or behaviour which makes you uncomfortable Please notify a member or staff immediately

1 7119 **KQ**
2 7119 **KQ**

GDPR Signs

Article 5 (1F) of GDPR states that personal data should be: "Processed in a way that ensures appropriate security of personal data, including protection against unauthorised or unlawful processing and against accidental loss or destruction or damage, using appropriate technical or organisational measures". This range of signs / posters have been designed to remind employees who deal with sensitive data to protect it by following a range of organisational measures.

PRINTER RULES
keep it confidential!

sensitive data
should be removed from the printer immediately

Control the whereabouts of products to avoid lost information

Are you doing enough to ensure sensitive files are handled securely?
It's not secure if people can see it!

Synthetic Paper
420 x 594mm
5 5635

COPIER RULES
keep it confidential!

sensitive data
should be removed from the copier immediately

Control the whereabouts of products to avoid lost information

Are you doing enough to ensure sensitive files are handled securely?
It's not secure if people can see it!

Synthetic Paper
420 x 594mm
5 5638

OFFICE RULES
keep it confidential!

sensitive data
should be securely stored and out of public view

Only hold as much data as you need, and only for as long as you need

Are you doing enough to ensure sensitive files are handled securely?
It's not secure if people can see it!

Synthetic Paper
420 x 594mm
5 5636

LAPTOP RULES
keep it confidential!

sensitive data
should be secured behind strong passwords

Control the whereabouts of products to avoid lost information

Are you doing enough to ensure sensitive files are handled securely?
It's not secure if people can see it!

Synthetic Paper
420 x 594mm
5 5637

Shred all documents

1 5639 **GM**
2 5639 **GM**

Shred sensitive documents before placing in bin

1 5640 **GM**
2 5640 **GM**

Peel & Stick Labels

A sheet of ten stickers to identify the plugs of key office appliances.

Self Adhesive Vinyl
40 x 18mm

5 4040

A sheet of ten stickers to advise staff not to unplug key office appliances.

Self Adhesive Vinyl
40 x 18mm

5 3438

A sheet of ten stickers to advise staff not to switch off key office appliances.

Self Adhesive Vinyl
40 x 18mm

5 3436

Material Codes

1 Rigid Plastic
2 Self Adhesive Vinyl
5 Miscellaneous

Landscape Sizes

B 80 x 80mm
C 300 x 100mm
K 400 x 300mm
M 600 x 200mm
Q 600 x 450mm

Portrait Sizes

A 75 x 100mm
E 150 x 200mm
H 250 x 300mm
K 300 x 400mm
Q 450 x 600mm

Schools & Offices

No eating or drinking in this area	No smoking outside the school gates	Do not leave valuables in changing rooms	Visitors must register at the main office	Please do not bring your mobile phones to school	Children must be supervised at all times	Please keep to the left
1 3232 EK 2 3232 EK	1 5462 EK 2 5462 EK	1 5442 E 2 5442 E	1 5461 EK 2 5461 EK	1 5471 EK 2 5471 EK	1 5465 EK 2 5465 EK	1 5240 E 2 5240 E

No mobile phone zone	No electronic devices allowed beyond this point	All Visitors	All Visitors
Greet your child with a smile, not a mobile		Please sign in at the main office	Please press button for assistance
1 5470 KQ 8 5470 K	1 5475 K 2 5475 K	1 5482 Q	1 5483 Q

Warning Trespassing or causing nuisance on a school site can lead to a criminal conviction under Section 547 of the Education Act 1996	Welcome to our playground Please treat our playground with respect. Children must be supervised at all times whilst using playground equipment at this school. This school will not be held responsible for any injury or accident that occurs through its use outside of normal school hours	Welcome to LOGO Please treat these grounds with respect. Children must be supervised at all times. We will not be held responsible for any injury or accident that occurs on these grounds	Welcome to LOGO Please treat this area with respect
7 4231 K	1 5478 KP	1 5477 KP	1 5476 KP

Add name or logo for free. Please specify when ordering.

Use handrail	Please keep right and hold the handrail	Please keep left and hold the handrail	No parking
1 5457 GM 2 5457 GM 8 5457 G	1 5489 GM 2 5489 GM	1 5488 GM 2 5488 GM	Stopping here puts children in danger
			1 5472 Q

Welcome to our school	Please close the gate	Please drive slowly	5 SLOW	10 SLOW	No idling
1 5479 P	1 5481 P	1 5480 P			Switch off engine Reduce emissions
					1 5473 Q

	School buses must display one of these signs at the front of the vehicle (at least 250mm x 250mm) and at the rear of the vehicle (at least 400mm x 400mm)	R2 Reflective on Aluminium Composite, complete with channelling	R2 Reflective on Aluminium Composite, complete with channelling
Reflective Aluminium	300 x 300mm 400 x 400mm	400 x 700mm	400 x 700mm
5 8530 5 8531	Face Adhesive 300 x 300mm 5 1687	5 5485	5 5484

Free Standing Signs

Yellow Polypropylene - 300 x 600mm - Double Sided

Browse our full range of double sided free standing signs on page 34. On this page you also have the option to create your own free standing sign.

5 8515 5 8547 5 8549

Lightweight Free Standing Signs

Fluted Polypropylene - 300 x 600mm - Double Sided

5 5041 5 8552 5 8501

Fluted Polypropylene

4mm thick material that is strong, lightweight and waterproof.

Coaches and Buses

Enables coach and bus operators to inform passengers of the obligations of Motor Vehicles (Wearing of Seat Belts) (Amendment) Regulations.

Seatbelts must be worn at all times

Passengers must remain seated at all times

Passengers must not stand forward of the driver's position

2 5439 **H**

Self Adhesive Vinyl
65mm Diameter
Sheet of 6
5 1651

Self Adhesive Vinyl
65mm Diameter
Sheet of 6
5 1652

Self Adhesive Vinyl
65mm Diameter
Sheet of 6
5 1650

2 5437 **F**

Car Park Notices

1 7575 **G M**

1 7576 **G M**

This car park is for residents and their visitors only

1 7798 **K**

1 7566 **G M**

Car Park Products
Browse our full range of car park signs and related products on pages 103-107.

1 7574 **K Q**

1 7075 **K**

1 7592 **K Q**
7 7592 **Q**

1 7106 **H**
2 7106 **H**

General Notices

1 7055 **E**
2 7055 **E**

1 7092 **E**
2 7092 **E**

1 7002 **K**

1 7006 **K**

1 7003 **K**

1 7037 **E**
2 7037 **E**

1 7044 **E K**
2 7044 **E K**

1 7596 **K**

1 7597 **K**

1 7030 **K**
6 7030 **K**

Garage Signs

Reflective Aluminium
600 x 625mm
5 7970

1 6510 **M**

1 6513 **G**

Self Adhesive
25 x 25mm
5 6487
150 x 150mm
5 6350

2 6518 **E H**

1 6511 **M**

1 6514 **G M**

Self Adhesive
25 x 25mm
5 6488
150 x 150mm
5 6330

Bespoke Labels

We can supply custom labels on sheets or rolls. Advise us of your required design, size and quantity and we'll provide you with a quote.



Material Codes

- 1 Rigid Plastic
- 2 Self Adhesive Vinyl
- 5 Miscellaneous
- 6 Aluminium
- 7 PET
- 8 Quick Fix

Landscape Sizes

- E 200 x 150mm
- F 200 x 200mm
- G 300 x 100mm
- H 300 x 250mm
- K 400 x 300mm
- M 600 x 200mm
- P 600 x 400mm
- Q 600 x 450mm

Portrait Sizes

- E 150 x 200mm
- H 250 x 300mm
- K 300 x 400mm
- P 400 x 600mm

Adapt-a-Signs 3mm PVC, with a hard wearing Clear PVC cover - 215 x 310mm.

A cost effective sign solution, allowing you to adapt the sign to manage any changes in personnel or company details. Helps ensure your signs remain up to date at all times. Developed to hold a standard A4 sheet of paper, which you can simply print off with your relevant contact details and insert into the sign frame.



5 1043



5 1059



5 1432



5 1423



5 6004



5 6027



5 6022



5 6083



5 1053



5 1035



5 1052



5 6079



5 1037



5 5436



5 1108



5 6091

Blank Adapt-a-Sign Frames

Use blank frames to display your own messages. Perfect for displaying escape route plans, information messages or an ideal solution for use in care homes or for anyone living with dementia. It allows you to print a photo of the actual room they are familiar with and recognise rather than displaying a generic door sign that may not be of help. You can also add a photo of the person to help them identify their bedroom etc.



Blue	5 6193
Green	5 6192
Black	5 6197
Red	5 6191
Yellow	5 6194

Need a Custom Adapt-a-Sign?

We can provide these in any colour or size. Simply contact us with the details you require and we will provide you with a quote.

Benefits of the Adapt-a-Sign System

Scoring out a persons name and scrawling a new one underneath it is unprofessional and unsightly, but equally, buying a new sign each time there are personnel changes seems wasteful.

The Adapt-a-Signs system gets rid of unsightly scribbles and unnecessary wastage by enabling a A4 print out to be inserted into the sign to show new personnel instead.



1. Replace your existing messy signage with a adapt-a-sign



2. Type up personnel details



3. Print out on A4 page



4. Insert printout into Adapt-a-Sign



5. Replace when details change

Once you have an Adapt-a-Sign in place, the next time there are personnel changes you can simply repeat steps 2-4 which saves time, money and removes confusion.

Braille & Tactile Signs 1.5mm 2-Ply PVC with Self Adhesive Backing

Our braille and tactile signs are manufactured to conform with the DDA Act 1995 and the Equality Act 2010. This legislation requires companies to provide all people equal access to public buildings, as well as to anyone providing a service to the public. Organisations must make "reasonable adjustments", one of which is providing large, well defined braille signs for visually impaired people.

Our braille and tactile signs come with a self adhesive back and are a durable, easy to install, scratch resistant PVC and suitable for internal use. Available in various colours and surface finishes. Laser and routing capabilities offer a high quality finish. Raised letters, symbols and braille help ensure people with visual impairment can read important messages. No need for additional signs as our braille / tactile range can be read by everyone.



 Toilet 225 x 150mm 5 6491	 Toilet 225 x 150mm 5 6492	 Toilet 225 x 150mm 5 6121	 Please Ask Staff For Help 225 x 150mm 5 6490	 Reception 300 x 150mm 5 6151	 Men 150 x 150mm 5 6109	 Women 150 x 150mm 5 6108		
 Floor 1 225 x 150mm 5 6130	 Floor 2 225 x 150mm 5 6131	 Floor 3 225 x 150mm 5 6132	 Alarm Pull Cord 225 x 150mm 5 6127	 Please Ring For Assistance 300 x 150mm 5 6149	 Toilet 150 x 150mm 5 6107	 Toilet 150 x 150mm 5 6110		
 ← Toilets 225 x 150mm 5 6493	 Toilets → 225 x 150mm 5 6494	 Shower 150 x 150mm 5 6115	 Baby 150 x 150mm 5 6114	 150 x 150mm 5 6103	 Entrance 150 x 150mm 5 6106	 Staff Only 150 x 150mm 5 6117	 Stairs 150 x 150mm 5 6118	 150 x 150mm 5 6104

Why both Braille & Tactile?

Fewer than 1% of the two million visually impaired people in the UK are users of Braille. Many people lose their sight when they are older and may never learn Braille, but they know how to recognise letters by their shape. For these people, the transition of learning to read tactile letters on a sign, is much easier than learning the new coding of Braille. Therefore BOTH tactile and Braille are key elements in helping the visually impaired to read and understand important signage messages.



Braille Number

Quote code 5 6136 and the number you require.

75 x 75mm
5 6136



 Fire Exit 450 x 150mm 5 6185	 Fire Exit 450 x 150mm 5 6186	 Fire Exit 450 x 150mm 5 6187	 Fire Exit 450 x 150mm 5 6199				
 No Smoking 300 x 150mm 5 6168	 Restricted Access 300 x 150mm 5 6171	 No Mobile Phones 300 x 150mm 5 6170	 Push bar to open 450 x 150mm 5 5929	 Push pad to open 450 x 150mm 5 5930			
 Refuge Point 300 x 150mm 5 6176	 Caution Forklift Trucks 300 x 150mm 5 6319	 Caution Mind The Step 300 x 150mm 5 6177	 First Aid 150 x 225mm 5 6180	 Drinking Water 150 x 225mm 5 6489	 Fire Alarm 150 x 225mm 5 6178	 Fire Extinguisher 150 x 225mm 5 6179	 Fire door Keep shut 150 x 150mm 5 5931

Ramp Access Signs

Often ramps are obscured and out of immediate site, which can lead to confusion and / or time being wasted. Ensure that ramps and disabled access is clearly visible and marked with this range of disabled access signs.

 Ramp access 1 7601 KQ	 Ramp access 1 7602 KQ	 Ramp access 1 7604 KQ	 Disabled parking only 1 7606 KQ 6 7606 K
------------------------------	------------------------------	------------------------------	--

Material Codes

- 1 Rigid Plastic
- 6 Aluminium
- 5 Miscellaneous

Landscape Sizes

- K 400 x 300mm
- Q 600 x 450mm

Material Information

Deciding on your sign message is only the first step. When ordering a sign, thought should also be given to where that sign is going to be displayed. For more information on our most popular materials and the locations they are most suitable for see pages 4-5.

Eco-Friendly Signs

Our two main materials which are both 100% recyclable have considerable variations in attributes. PET is ultra durable, impact, fire and vandal resistant making them perfect for harsh environments but with a high quality finish. Fluted polypropylene is strong and lightweight making them perfect for temporary installations.



4mm Fluted Polypropylene
 100% Recyclable within waste group (PP5)
 Fluted twin wall polypropylene sheet
 Perfect for short term / temporary signage
 Durable, Lightweight and Waterproof
 Highly cost-effective material

2mm PET
 100% Recyclable within waste group (PET1)
 Resistant to sub zero temperatures down to -20C
 Sub surface printed makes it vandal resistant
 Fire resistant (difficult to ignite) to EN13501-1 B - s1, d0
 Chemical resistance against agents, oils and solvents

Fluted Polypropylene Signs Additional signs can be found on pages 126 - 127.

 Your Logo Here 600 x 400mm 5 5757	 Your Logo Here 600 x 400mm 5 5758	 Your Logo Here 600 x 400mm 5 5753	 Your Logo Here 600 x 400mm 5 5747	 Your Logo Here 600 x 400mm 5 5745
 Your Logo Here 600 x 400mm 5 5776	 Your Logo Here 600 x 400mm 5 5775	 All contractors must obtain a valid permit to work on this site Your Logo Here 600 x 400mm 5 5783	 Your Logo Here 600 x 400mm 5 5763	 Your Logo Here 600 x 400mm 5 5762
 Your Logo Here 600 x 400mm 5 5789	 Your Logo Here 600 x 400mm 5 5790	 Your Logo Here 600 x 400mm 5 5791	 Your Logo Here 600 x 400mm 5 5781	 Your Logo Here 600 x 400mm 5 5785
 Your Logo Here 400 x 400mm 5 5728	 Your Logo Here 400 x 400mm 5 5729	 Your Logo Here 400 x 400mm 5 5727	 Your Logo Here 400 x 400mm 5 5740	 Your Logo Here 400 x 400mm 5 5744
 Your Logo Here 400 x 400mm 5 5743	 Your Logo Here 400 x 400mm 5 5742	<div style="display: flex; justify-content: space-between;"> <div> All visitors & drivers must report to site office Children must not play on this site Construction work in progress. Parents are advised to warn children of the dangers of entering this site. High visibility jackets must be worn Report all accidents immediately Danger Deep excavations Protective footwear must be worn Danger Stop. Look. Listen. Beware of trucks. Safety helmets are provided for your safety and must be worn No access for unauthorised personnel YOUR LOGO HERE 1220 x 1220mm 5 5798 </div> <div> Under the Health and Safety at Work Act 1974 all persons entering this site must comply with all regulations under this act. All visitors must report to the site office and obtain permission to proceed onto the site or any work area. Safety signs and procedures must be observed and personal protection and safety equipment must be used at all times. Construction work in progress. Parents are advised to warn children of the dangers of entering this site. Safety helmets must be worn Protective footwear must be worn High visibility jackets must be worn Unauthorised entry to this site is strictly forbidden YOUR LOGO HERE 1220 x 1220mm 5 5794 </div> <div> Under the Health and Safety at Work Act 1974 all persons entering this site must comply with all regulations under this act. All visitors must report to the site office and obtain permission to proceed onto the site or any work area. Safety signs and procedures must be observed and personal protection and safety equipment must be used at all times. Warning Dangerous site All visitors must report to the site office Approved personal protective equipment must be worn No unauthorised access YOUR LOGO HERE 1220 x 1220mm 5 5793 </div> </div>		

Eco-Friendly Pack
 Twelve Sign Pack
 Fluted Polypropylene
 5 5820

 1220 x 610mm

1220 x 1220mm

400 x 400mm

400 x 400mm

400 x 400mm

400 x 400mm

400 x 400mm

400 x 400mm

600 x 400mm

600 x 400mm

Custom Eco-Signs
 Can't see the sign you required?
 Don't worry you can order any sign in fluted polypropylene, PET or any other eco-friendly material. Simply go to page 148 for more information.



Eco-Friendly Signs

To help encourage an environmentally friendly approach to signage we now include the appropriate recycling logo on the sign to help identify when one of our signs can be recycled and to help recycling centres correctly identify and process the materials efficiently without the need to send them into landfill.

PET Ultra Durable Signs

 7 1013 EK	 7 1010 EK	 7 1014 EK	 7 1405 EH	 7 1429 EH	 7 1712 HK	 7 1721 HK
 7 2004 GL	 7 2003 GL	 7 2007 GL	 7 2008 GL			
 7 1605 BF	 7 1606 B	 7 1610 B	 7 1618 B	 7 1619 B	 7 1635 B	 7 2059 Q
 7 4009 GM	 7 4215 GMP	 7 1720 GM				
 7 1714 GM	 7 1715 GM	 7 6404 MP	 7 6216 GM			
 7 3003 GM	 7 3213 GM	 7 3218 GM	 7 5216 M			
 7 3407 GMP	 7 3201 GMP	 7 3611 GMP	 7 6401 M			
 7 6412 Q	 7 6431 Q	 7 6438 Q	 7 7525 Q			
 7 7524 Q	 7 7571 Q	 7 3221 Q	 7 7592 Q			
 7 6408 G	 7 7061 GM	 7 7053 GL	 7 7051 GL			

Material Codes
5 Miscellaneous
7 PET

Landscape Sizes
B 80 x 80mm
L 450 x 150mm
G 300 x 100mm
M 600 x 200mm
P 600 x 400mm
Q 600 x 450mm

Portrait Sizes
E 150 x 200mm
H 250 x 300mm
K 300 x 400mm
P 400 x 600mm
Q 450 x 600mm

Engraved Signs Aluminium or Brass Effect - Adhesive Backing - Engraved 1.5mm PVC

These signs are manufactured from a 2-ply PVC laminate with a aluminium or brass effect which creates a cost effective, durable and professional finish.

 <p>Toilet</p> <p>Aluminium Effect 140 x 35mm 5 9119 Brass Effect 140 x 35mm 5 9118</p>	 <p>Private</p> <p>Aluminium Effect 140 x 35mm 5 9059 Brass Effect 140 x 35mm 5 9058</p>	 <p>Aluminium 70 x 140mm 5 9067 Brass 70 x 140mm 5 9066</p>	 <p>Aluminium 70 x 140mm 5 9069 Brass 70 x 140mm 5 9068</p>	 <p>Reception</p>
 <p>Reception</p> <p>Aluminium Effect 140 x 35mm 5 9061 Brass Effect 140 x 35mm 5 9060</p>	 <p>Staff Only</p> <p>Aluminium Effect 140 x 35mm 5 9081 Brass Effect 140 x 35mm 5 9080</p>	 <p>Aluminium 35 x 70mm 5 9071 Brass 35 x 70mm 5 9070</p>	 <p>Aluminium 35 x 70mm 5 9073 Brass 35 x 70mm 5 9072</p>	 <p>PUSH PULL</p> <p>Aluminium Effect 75 x 300mm 5 9177 Brass Effect 75 x 300mm 5 9166</p> <p>Aluminium Effect 75 x 300mm 5 9178 Brass Effect 75 x 300mm 5 9167</p>
 <p>Office</p> <p>Aluminium Effect 140 x 35mm 5 9089 Brass Effect 140 x 35mm 5 9088</p>	 <p>Manager</p> <p>Aluminium Effect 140 x 35mm 5 9085 Brass Effect 140 x 35mm 5 9084</p>			
 <p>Kitchen</p> <p>Aluminium Effect 140 x 35mm 5 9079 Brass Effect 140 x 35mm 5 9078</p>	 <p>Bathroom</p> <p>Aluminium Effect 140 x 35mm 5 9065 Brass Effect 140 x 35mm 5 9064</p>			

Custom Engraved Signs

Provide a professional and attractive look throughout a facility with engraved signs which can be supplied in a wide range of materials and sizes. The top layer of this material is removed during the engraving process to reveal the sub-layer that contrasts with the surface colour. Includes a self-adhesive backing for easy installation.



Options	95mm Dia	100 x 75mm	300 x 100mm	140 x 35mm	35 x 70mm
TEXT Black Text on White	5 1548	5 1554	5 1560	5 1567	5 1573
TEXT White Text on Black	5 1549	5 1555	5 1561	5 1568	5 1574
TEXT White Text on Red	5 1550	5 1556	5 1562	5 1569	5 1575
TEXT White Text on Blue	5 1551	5 1557	5 1563	5 1570	5 1576
TEXT White Text on Green	5 1552	5 1558	5 1564	5 1571	5 1577
TEXT Black Text on Yellow	5 1553	5 1559	5 1566	5 1572	5 1578
TEXT Aluminium Effect	-	5 1597	5 1599	5 1496	5 1498
TEXT Brass Effect	-	5 1598	5 1600	5 1497	5 1499



Custom Composite Signs

State the required text when ordering and we'll make your bespoke sign.

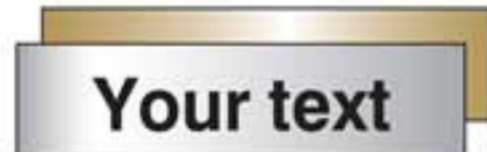
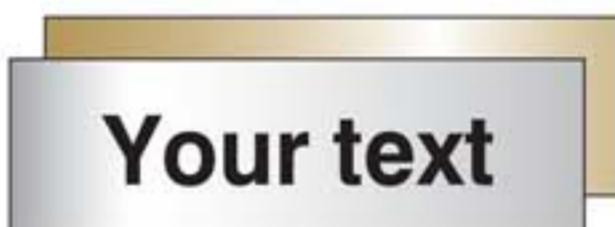
This elegant and professional looking selection of signs offer the look and feel of a deluxe brushed aluminium or brass sign but without the added expense by using a 1.5mm brass or aluminium effect composite material.

 <p>Aluminium Effect 140 x 35mm 5 8858 Brass Effect 140 x 35mm 5 8859</p>	 <p>Aluminium Effect 300 x 100mm 5 8856 Brass Effect 300 x 100mm 5 8857</p>	 <p>Aluminium Effect 150 x 200mm 5 8860 Brass Effect 150 x 200mm 5 8861</p>
--	---	--

Aluminium Door Sliders

300 x 40mm - Anodised Aluminium - Self Adhesive Backing



Single Message

Meeting in progress	5 9121
Do not disturb	5 9112
Examination in progress	5 9114
Your text	5 9005

Double Message

In	Out	5 9113
Room in use	Room available	5 9147
Closed	Open	5 9116
Engaged	Vacant	5 9117

Deluxe Signs

Sometimes a standard sign is not enough and the location requires something a little more elegant. Our deluxe range offers a choice of finishes to help your signs stand out from the crowd.

Acrylic Visual Impact Door Signs

Stand-offs give your signs extra visual impact as they stand out from the wall or door. Acrylic materials provide a contemporary appearance which is perfect for hotels, retail and high profile establishments. If you can't find the message you are looking for then use the code 5 9688 to create your own.

5mm Clear Acrylic - Sub-surface Frosted Crystal Vinyl - Anodised Aluminium Stand-offs



450 x 150mm
5 9192



450 x 150mm
5 9188



200 x 200mm
5 9194



450 x 150mm
5 9190



450 x 150mm
5 9189



200 x 200mm
5 9195



450 x 150mm
5 9191



450 x 150mm
5 9187



200 x 200mm
5 9196

Custom Visual Impact Signs

Add a contemporary feel with these popular acrylic stand off signs. You can personalise the designs to show any message, image or graphic you require. Simply supply the message / logo or image you wish when ordering.

If you need a different size, call us for a quote



450 x 150mm
5 9688

Please state your required text when ordering



Acrylic Visual Impact Safety Signs

5mm clear acrylic with subsurface print and a frosted crystal backing.

Includes anodised aluminium stand-offs for mounting. Perfect for contemporary buildings.



200 x 150mm
5 1237



200 x 150mm
5 1233



200 x 150mm
5 1234



200 x 150mm
5 1235



450 x 150mm
5 9468



450 x 150mm
5 9467



450 x 150mm
5 9469



450 x 150mm
5 9470

Photoluminescent Acrylic Visual Impact Safety Signs

5mm clear acrylic with subsurface print and a photoluminescent backing.

Includes anodised aluminium stand-offs for mounting.



200 x 150mm
5 1253



200 x 150mm
5 1256



200 x 150mm
5 1255



200 x 150mm
5 1254



450 x 150mm
5 9472



450 x 150mm
5 9471



450 x 150mm
5 9473



450 x 150mm
5 9474

Aluminium Visual Impact Door Signs

200 x 50mm - Aluminium - Anodised Aluminium Stand-offs



200 x 50mm
5 9618



200 x 50mm
5 9616



200 x 50mm
5 9614



200 x 50mm
5 9689



200 x 50mm
5 9619



200 x 50mm
5 9617



200 x 50mm
5 9615

Please state your required text when ordering. If you require this sign in a different size, contact us for a quote.

Deluxe

Deluxe Door Discs 76mm Diameter - Pre-drilled - Fixings Included

A range of stylish door signs that are ideal for prestigious environments where a high quality finish is essential. Supplied pre-drilled and with screw fixings.



Aluminium and Brass Safety Signs

Manufactured from anodised aluminium or brass with printed detail. Ideal for prestigious environments. These signs are supplied with a self adhesive backing for easy installation.

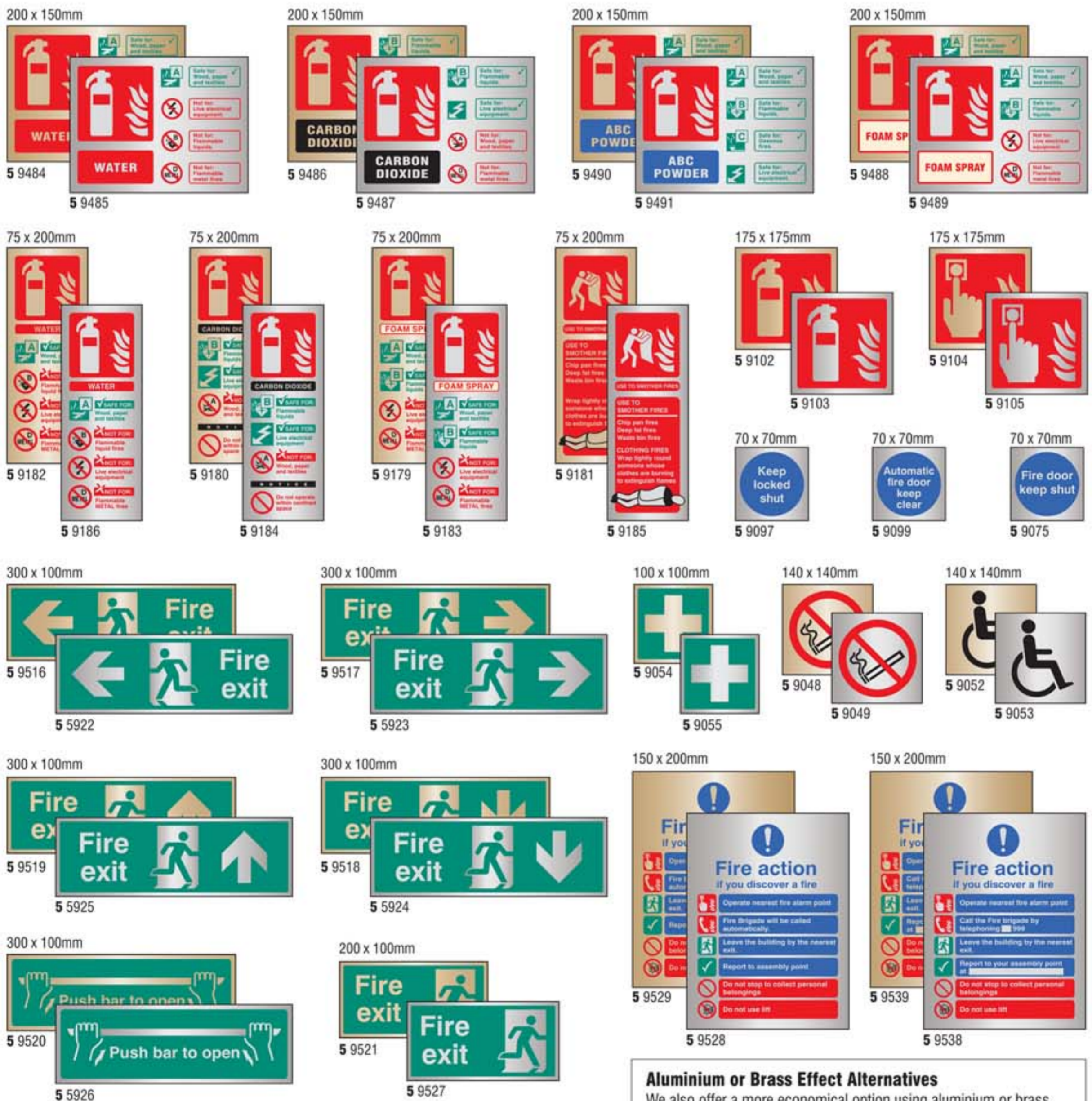

Aluminium or Brass Effect Alternatives
We also offer a more economical option using aluminium or brass effect composite materials - see page 92 for available options.

Engraved

Our range of engraved products are supplied on a 2-ply 1.5mm rigid PVC laminate. This material is heat-resistant and robust to withstand the toughest of environments, making them a cost effective and practical solution for many industrial applications. Engraved signs and tags provide a permanent and effective message, removing the risk of print being scratched or damaged during general cleaning and maintenance. If you can't find the size or shape that you require please contact us for a quote.



Engraved Valve Tags

Pack of 50 - 1.5mm 2 Ply PVC Engraved Valve Tags

Our valve tags are engraved to give better quality than printed, stamped or punched alternatives. The tags are drilled at the top centre allowing you to fix to a ball chain or split ring.

Numbered Only

Each pack contains fifty sequential numbers. Please specify the number range required (eg. 1-50)

Numbered with Prefix

Each pack contains fifty sequential numbers with prefix lettering. Please specify the number range and prefix you require (eg. GAS:1-50, T:51-100)



Numbered Only	27mm	38mm
TEXT Black Text on White	5 1500	5 1506
TEXT White Text on Black	5 1501	5 1507
TEXT White Text on Red	5 1502	5 1508
TEXT White Text on Blue	5 1503	5 1509
TEXT White Text on Green	5 1504	5 1510
TEXT Black Text on Yellow	5 1505	5 1511

Number & Prefix	27mm	38mm
TEXT Black Text on White	5 1512	5 1518
TEXT White Text on Black	5 1513	5 1519
TEXT White Text on Red	5 1514	5 1520
TEXT White Text on Blue	5 1515	5 1521
TEXT White Text on Green	5 1516	5 1522
TEXT Black Text on Yellow	5 1517	5 1523

Accessories

Don't forget to order connectors such as split rings or ball chains for tags and fobs



Split Ring
Nickel Plated
Steel
25mm Dia
5 5160

Tin Plated
Ball Chain
Pack of 50
(100mm)
5 5161

Engraved Key Fobs

1.5mm 2 Ply PVC Engraved Key Fobs

These key fobs are supplied complete with drilled hole for key ring attachment. Larger sized key fobs help prevent risk of keys being lost or left behind and allow additional information to be engraved such as room numbers or contact number. Please specify your text of choice when ordering. Split rings available to purchase separately.

Oval	78 x 150mm	50 x 100mm
TEXT Black Text on White	5 1524	5 1530
TEXT White Text on Black	5 1525	5 1531
TEXT White Text on Red	5 1526	5 1532
TEXT White Text on Blue	5 1527	5 1533
TEXT White Text on Green	5 1528	5 1534
TEXT Black Text on Yellow	5 1529	5 1535

Rectangle	78 x 150mm	50 x 100mm
TEXT Black Text on White	5 1542	5 1536
TEXT White Text on Black	5 1543	5 1537
TEXT White Text on Red	5 1544	5 1538
TEXT White Text on Blue	5 1545	5 1539
TEXT White Text on Green	5 1546	5 1540
TEXT Black Text on Yellow	5 1547	5 1541



Engraved Signs

1.5mm 2 Ply PVC Engraved Adhesive Backed Signs

Ideal for creating door signs, table numbers or industrial tags, the permanently engraved surface has the advantage of being tamper proof, and is less easily damaged by general cleaning and maintenance. This range of signs are supplied with a strong self-adhesive backing for ease of installation. Please specify your text of choice when ordering.

Options	95mm Dia	100 x 75mm	300 x 100mm	140 x 35mm	35 x 70mm
TEXT Black Text on White	5 1548	5 1554	5 1560	5 1567	5 1573
TEXT White Text on Black	5 1549	5 1555	5 1561	5 1568	5 1574
TEXT White Text on Red	5 1550	5 1556	5 1562	5 1569	5 1575
TEXT White Text on Blue	5 1551	5 1557	5 1563	5 1570	5 1576
TEXT White Text on Green	5 1552	5 1558	5 1564	5 1571	5 1577
TEXT Black Text on Yellow	5 1553	5 1559	5 1566	5 1572	5 1578
TEXT Aluminium Effect	-	5 1597	5 1599	5 1496	5 1498
TEXT Brass Effect	-	5 1598	5 1600	5 1497	5 1499



Deluxe Signs



Require something a little more elegant?
Our stand-off range help signs stand out from the crowd.
See page 93 for more information.

ID Tags

Use these ID tags for asset marking or equipment checks. Manufactured from durable 0.8mm polypropylene which is resistant to chemicals and high temperatures.

Supplied plain or specify print requirements when ordering.

Options	Self Tie	Wide Tag
White	5 5150	5 5155
Red	5 5151	5 5156
Blue	5 5152	5 5157
Green	5 5153	5 5158
Yellow	5 5154	5 5159



Self Tie Tag
0.8mm Polypropylene
210 x 50mm
Pack of 14



Wide Flag Tag
0.8mm Polypropylene
100 x 65mm
Pack of 20

Lock Out Tag Out

The term lock out tag out (LOTO) refers to a safety procedure that ensures that machinery and energy sources are properly shut off and not unexpectedly / accidentally started up before the completion of maintenance or servicing work. These energy sources could include electrical, mechanical, hydraulic, pneumatic, chemical, radiation and thermal hazards. The point of a LOTO procedure is to identify and isolate a hazard that may cause injury if it were to start up or release stored energy during the maintenance process.



Hasps

Isolate a piece of equipment with multiple padlocks.

Six (6mm Dia.) holes on the handle for 6 individual padlocks.

25mm Clearance **5 3313**
38mm Clearance **5 3314**



Padlocks

Thermoplastic padlocks with a steel shackle. Temperature, chemical and corrosion resistant, UV stable.

Every padlock is supplied with a unique key for maximum security.

For keyed alike versions please call for a quote.



Green **5 3318** Purple **5 3320** Red **5 3315** Teal **5 3321** Yellow **5 3317** Orange **5 3316** Blue **5 3319** Black **5 3322**

Rotating Gate Valve Cover



Gate valve covers are a simple, low cost and highly effective way to prevent unauthorised operation of valves. Valve covers consist of two flattened half moons that slip over the valves hand wheel and completely cover it. Once locked, the cover rotates freely around the hand wheel preventing operation.

Fits Valve Diameter	A. Inner Diameter	B. Inner Height	C. Outer Diameter	D. Outer Height	E.Lock Hole	Code
25 - 70mm	70mm	32mm	76mm	38mm	8mm	5 3336
70 - 130mm	130mm	32mm	140mm	44mm	9.5mm	5 3337
130 - 170mm	170mm	38mm	177mm	50mm	9.5mm	5 3338
170 - 257mm	257mm	50mm	267mm	63mm	9.5mm	5 3339
257 - 355mm	355mm	63mm	368mm	73.8mm	9.5mm	5 3340

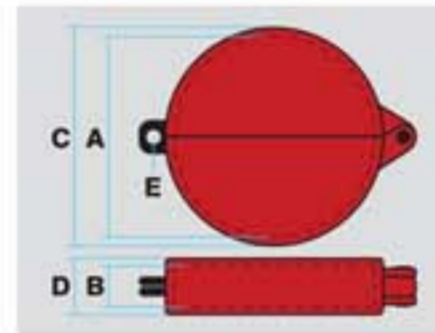

Breaker Lockout

This miniature circuit breaker (MCB) lockout device is universal for many makes and models. It requires no tools to fit it on to the MCB and locks out virtually all ISO / DIN circuit breakers throughout the world.

Dimensions: 52.65 x 17.70 x 29.99mm
Body: PBT with brass thread insert
Cover: PBT and Thermoplastic
Screw: Stainless Steel
Operating Temperature: -40°C to 70°C
Corrosion Resistance* ASTM F883 Grade 6

5 3312



Electrical Plug Lock Out

A simple and effective plug lockout device which is especially developed to secure all types of plugs. Completely encloses electrical plugs to prevent accidental reconnection. When closed the access hole will accept a cable up to a diameter of 25mm



Small 90 x 50 x 50mm **5 3304**
Large 180 x 80 x 80mm **5 3305**

Lock Out Tag Out Kit

This Lock Out Kit includes devices for locking off valves and electrical isolators.

6 x Red Padlocks (Keyed Alike)
2 x Lockout Hasps
3 x Adjustable Cable Lockout
1 x 25-76mm Gate Valve Lockout
1 x 50-127mm Gate Valve Lockout
1 x 101-165mm Gate Valve Lockout
1 x Ball Valve Lockout
6 x MCB Lockout (Standard)
2 x MCB Lockout (Wide pins)

5 3331



Portable Lockout Box

Mild steel with red polyester powder coating. Includes key drop facility on lid.

12 Padlock Locators (Padlocks not included) Up to 8mm Shackle Dia.

152 x 230 x 95mm
Weight: 1.85kg

5 3332



Cable Lock Out

Ideal for use on gate valves or to lockout multiple items. Manufactured from tough thermoplastic with 4mm dia steel cable, vinyl coated. The cable length is 1.8m and the lock out point accepts up to 4 padlocks for multiple lockout applications.

Any slack in the cable can be taken out without the need to remove padlocks

5 3303



Lock Out Tag Out Stations

Lock Out Stations ensure that LOTO equipment is readily available from a central location. Manufactured from 5mm foam PVC and supplied with contents. The striking black and yellow border ensures that the station is highly visible wherever sited. Corresponding shadow profiles of each item of equipment on the station helps easy inventory checking and highlights when replacements are required.



20 Lockout Station Includes:
 20 x Shackle Padlocks
 (38mm - Red - Keyed Differently)
 2 x Hasps (25mm - Red)
 80 x Do not Operate Tags
 Dimensions: 660 x 520mm
 5 3329



10 Lockout Station Includes:
 10 x Shackle Padlocks
 (38mm - Red - Keyed Differently)
 1 x Hasps (25mm - Red)
 40 x Do not Operate Tags
 Dimensions: 360 x 540mm
 5 3328

Bespoke Stations

For alternative sizes, design and / or contents, contact us for a quote.



4 Lockout Station Includes:
 4 x Shackle Padlocks
 (38mm - Red - Keyed Differently)
 1 x Hasps (25mm - Red)
 10 x Do not Operate Tags
 Dimensions: 280 x 400mm
 5 3327

Double Sided Lock Out Tags

80 x 150mm - Double sided and manufactured from matt PVC. Supplied in packs of 10 with 150mm cable ties



Lock Out Tag Out Signs



Free Standing Signs

A perfect way to advise staff and other personnel of any type of short term lock out procedure being undertaken.



Full Range of Free Standing Signs

Our full range of free-standing signs can be found on page 34.

Projecting Sign

Ensure lockout stations are easily identified and visible. EasiFIX kits are supplied with guide for easy installation. Fixings hidden for neat finish

Rigid Plastic
Face: 150 x 200mm
5 3330



Bespoke Projecting Signs

Need a projecting sign that's not in our catalogue? Don't worry; we can create custom projecting signs to suit your requirements.

GHS & COSHH Information

The classification and labelling aspects of CLP/GHS have applied to substances since 1 December 2010 and to mixtures since 1 June 2015. The final deadline fell on 1 June 2017 and applied to mixtures that were already on the market before 1 June 2015 - the transitional period was intended to give suppliers time to either deplete stock that was already on the market or to arrange for re-packaging and re-labelling of goods to be completed before 1 June 2017.

Control of Substances Hazardous to Health Regulations 2002 (CoSHH)

Under CoSHH all persons at work need to know the safety precautions to take so as not to endanger themselves or others through exposure to substances hazardous to health.

What you need to know

Employers Must

- Assess health risks to employees and others working on the premises.
- Initiate procedure to control and monitor unavoidable exposure to substances which may harm the health of employees and others on the premises.
- Provide information and training relevant to the hazards associated within each area of working to ensure that all personnel are aware of the risks involved and preventative measures taken to control them.

Employees Must

- Make full and proper use of any control measure, personal protective equipment (PPE) or other facility provided.
- Report any defects found in the control measures, PPE or facilities provided.
- Follow the instructions provided within data sheets or other safety information and only use and dispose of substances in the recommended manner.

Get to know the warning symbols

Rigid Plastic
400 x 600mm
5 8117

Handling Chemicals Safely

- All chemicals should be clearly marked
- Be aware of the storage requirements of each type
- Take extreme care when mixing chemicals
- Keep away from heat and flames
- Avoid oral contact of any kind
- Never inhale
- Avoid contact with skin and eyes

Chemical Checklist

- Read and understand the label before opening any container
- Double-check that the chemical you are opening is the one required
- Consider the hazards, including violent reactions between chemicals
- Open container carefully in a well ventilated area
- Always wear appropriate protective clothing
- Take extreme care whilst using hazardous chemicals
- Use method which reduces risk of inhalation, ingestion or contact with skin, eyes and clothing
- Never eat, drink or smoke whilst handling chemicals
- Always seal container tightly after use

Know your CoSHH and GHS Warning Symbols

Rigid Plastic
400 x 600mm
5 8136

Know Your GHS and CHIP Warning Symbols

The Globally Harmonized System (GHS) of classification and labelling of chemicals was introduced in 2002 and sees the gradual phasing out of the orange and black CHIP labels. This poster has been designed to help employees identify the hazardous nature of chemicals through recognition of the symbols shown below.

Hazard: Explosive GHS Symbol CHIP Symbol	Hazard: Flammable GHS Symbol CHIP Symbol	Hazard: Oxidizing GHS Symbol CHIP Symbol
Hazard: Compressed Gas GHS Symbol CHIP Symbol	Hazard: Corrosive GHS Symbol CHIP Symbol	Hazard: Toxic GHS Symbol CHIP Symbol
Hazard: Irritant GHS Symbol CHIP Symbol	Hazard: Health Hazard GHS Symbol CHIP Symbol	Hazard: Environmental Hazard GHS Symbol CHIP Symbol

Rigid Plastic
400 x 600mm
5 8165

Recommended Segregation for Storage of Hazardous Substances

Where a particular material has the properties of more than one class, the classification giving the more onerous segregation should be given

CLASS	1	2	3	4	5	6	7
Compressed Gases							
2.1 Flammable	KEEP APART	KEEP APART	Segregate from	Segregate from	Segregate from	ISOLATE	KEEP APART
2.2 Non-flammable/non-toxic	KEEP APART	KEEP APART	KEEP APART	Segregation may not be necessary	Segregation may not be necessary	Segregation may not be necessary	KEEP APART
2.3 Toxic	Segregation may not be necessary	KEEP APART	Segregate from	KEEP APART	KEEP APART	Segregation may not be necessary	KEEP APART
Flammable Liquids							
2.1 Flammable	Segregate from	KEEP APART	Segregate from	KEEP APART	Segregate from	Segregate from	KEEP APART
2.2 Spontaneously combustible	Segregate from	Segregate from	Segregate from	KEEP APART	KEEP APART	Segregate from	KEEP APART
2.3 Dangerous when wet	Segregate from	Segregation may not be necessary	KEEP APART	Segregate from	KEEP APART	Segregation may not be necessary	Segregation may not be necessary
Oxidising Substances							
5.1 Oxidising Substances	Segregation may not be necessary	Segregation may not be necessary	Segregation may not be necessary	Segregate from	Segregation may not be necessary	Segregation may not be necessary	KEEP APART
5.2 Organic peroxides	ISOLATE	Segregation may not be necessary	Segregation may not be necessary	ISOLATE	Segregation may not be necessary	Segregation may not be necessary	KEEP APART
Toxic Substances							
6.1 Very Toxic	KEEP APART	Segregation may not be necessary	Segregation may not be necessary	KEEP APART	KEEP APART	Segregation may not be necessary	Segregation may not be necessary
6.2 Toxic	KEEP APART	KEEP APART	KEEP APART	KEEP APART	KEEP APART	KEEP APART	Segregation may not be necessary
Corrosive Substances							
8.1 Corrosive	KEEP APART	KEEP APART	KEEP APART	Segregation may not be necessary	KEEP APART	KEEP APART	Segregation may not be necessary

Rigid Plastic
900 x 600mm
5 8176

COSHH Document Holder

For our full range of document holding signs see page 45.

Keep important COSHH documents clearly displayed and readily available in a central location.

Includes a clear polystyrene document holder.

440 x 600mm
10mm Foam Board
5 8214

Spill kit station

- 1 Protect**
Evacuate non-essential personnel.
Assess the spill and identify the liquid.
Choose the appropriate protective clothing and safety equipment to respond safely.
- 2 Confine**
Confine the liquid with absorbent booms or socks.
Overlap the ends of the socks by several inches to prevent any liquid from breaking through.
- 3 Clean up**
Clean up the spill with pillows, mats or hoses absorbents.
Place the absorbents starting from the outside of the spill working inward.
- 4 Dispose**
Place saturated absorbents in the provided yellow temporary disposal bags and close with plastic ties.
Dispose of properly.

1 6000 W

Spill Kit Products
For more spill kit signage and products see page 75 or contact us if you have a bespoke requirement.

Hazard symbols most commonly encountered

TO ALL PERSONNEL
GHS labels classify chemicals in regard to their hazardous properties. Please pay particular attention to any container or product bearing any of the symbols illustrated.

ALWAYS
Follow departmental instructions for the protection of your health and safety.

1 6484 Q
2 6484 Q

Know Your GHS and CHIP Warning Symbols

Front

Reverse

Laminated 50GSM Rigid Cards
Pack of 10
75 x 90mm
5 8164

Self Adhesive Tab
Pack of 4 - 10 x 25mm - 5 8724

Hazardous Substance

The carriage of dangerous goods by road, rail, inland waterway, sea and air is regulated internationally by European agreements, directives and regulations, and parallel legislation in the UK. Dangerous goods are assigned to different classes depending on their hazard. The person or business shipping the goods is responsible for classifying, marking and packaging the dangerous goods. ADR sets out the requirements for the classification, packaging and certification of dangerous goods being transported by road.

As well as the requirements specific to their transportation, suppliers of dangerous goods are required by law to label their products and packaged chemicals with hazard symbols and safety advice. Recognised GHS symbols have been developed so that people handling hazardous goods know the nature of the hazard they present.

GHS is the Globally Harmonised System of classification and labelling of chemicals (sometimes also referred to as CLP). GHS came into effect in 2009, phasing out the old black & orange CHIP designs by June 2015. The aim of the GHS regulation is to create a worldwide recognisable system of chemical classification and labelling.

GHS Labels

1 4540 U 2 4540 U	1 4541 U 2 4541 U	1 4542 U 2 4542 U	1 4543 U 2 4543 U	1 4544 U 2 4544 U	1 4545 U 2 4545 U	1 4546 U 2 4546 U	1 4547 U 2 4547 U	1 4548 U 2 4548 U
Roll of 250 Adhesive Labels 50 x 50mm 5 8141	Roll of 250 Adhesive Labels 50 x 50mm 5 8142	Roll of 250 Adhesive Labels 50 x 50mm 5 8143	Roll of 250 Adhesive Labels 50 x 50mm 5 8144	Roll of 250 Adhesive Labels 50 x 50mm 5 8145	Roll of 250 Adhesive Labels 50 x 50mm 5 8146	Roll of 250 Adhesive Labels 50 x 50mm 5 8147	Roll of 250 Adhesive Labels 50 x 50mm 5 8148	Roll of 250 Adhesive Labels 50 x 50mm 5 8149
Roll of 250 Adhesive Labels 100 x 100mm 5 8150	Roll of 250 Adhesive Labels 100 x 100mm 5 8151	Roll of 250 Adhesive Labels 100 x 100mm 5 8152	Roll of 250 Adhesive Labels 100 x 100mm 5 8153	Roll of 250 Adhesive Labels 100 x 100mm 5 8154	Roll of 250 Adhesive Labels 100 x 100mm 5 8155	Roll of 250 Adhesive Labels 100 x 100mm 5 8156	Roll of 250 Adhesive Labels 100 x 100mm 5 8157	Roll of 250 Adhesive Labels 100 x 100mm 5 8158

Hazardous Substance Labels

1 4476 F 2 4476 FU	1 4477 FU 2 4477 FU	1 4513 F 2 4513 FU	1 4517 F 2 4517 FU	1 4506 FU 2 4506 FU	1 4516 F 2 4516 FU	1 4433 FU 2 4433 FU	1 4434 FU 2 4434 FU	1 9745 FU 2 9745 FU
Roll of 100 Adhesive Labels 100 x 100mm 5 9742	Roll of 100 Adhesive Labels 100 x 100mm 5 9743	Roll of 100 Adhesive Labels 100 x 100mm 5 4513	Roll of 100 Adhesive Labels 100 x 100mm 5 4517	Roll of 100 Adhesive Labels 100 x 100mm 5 9740	Roll of 100 Adhesive Labels 100 x 100mm 5 9744	Roll of 100 Adhesive Labels 100 x 100mm 5 9738	Roll of 100 Adhesive Labels 100 x 100mm 5 9739	Roll of 100 Adhesive Labels 100 x 100mm 5 9745
1 4436 F 2 4436 FU	1 4478 F 2 4478 FU	1 4432 F 2 4432 FU	1 4501 F 2 4501 FU	1 4502 F 2 4502 FU	1 4438 F 2 4438 FU	1 4508 F 2 4508 FU	1 4509 F 2 4509 FU	1 4510 F 2 4510 FU
Roll of 100 Adhesive Labels 100 x 100mm 5 9742	Roll of 100 Adhesive Labels 100 x 100mm 5 9743	Roll of 100 Adhesive Labels 100 x 100mm 5 4513	Roll of 100 Adhesive Labels 100 x 100mm 5 4517	Roll of 100 Adhesive Labels 100 x 100mm 5 9740	Roll of 100 Adhesive Labels 100 x 100mm 5 9744	Roll of 100 Adhesive Labels 100 x 100mm 5 9738	Roll of 100 Adhesive Labels 100 x 100mm 5 9739	Roll of 100 Adhesive Labels 100 x 100mm 5 9745

Roll of 250 Adhesive Labels 100 x 100mm 5 8159	Roll of 100 Adhesive Labels 100 x 100mm 5 9836	Roll of 100 Adhesive Labels 100 x 100mm 5 9835	2 4557 FU Roll of 100 Adhesive Labels 100 x 100mm 5 9837	2 4558 FU Roll of 100 Adhesive Labels 100 x 100mm 5 9838

1 4511 F 2 4511 FU	1 4512 F 2 4512 FU	1 4515 F 2 4515 FU	1 4435 F 2 4435 FU
Roll of 100 Adhesive Labels 100 x 100mm 5 9744	Roll of 100 Adhesive Labels 100 x 100mm 5 9744	Roll of 100 Adhesive Labels 100 x 100mm 5 9738	Roll of 100 Adhesive Labels 100 x 100mm 5 9745

We can supply Hazardous Substance Diamonds on a magnetic material. Contact us for a quote.

Rolls of Safety Symbol Labels

These self adhesive labels are conveniently supplied in Rolls of 100. All our labels are ready cut and easy to peel off and apply. They can also be supplied as individuals or on sheet format. If you cannot find the label you require we will be happy to quote you for your requirements.

50 x 50mm 5 9719	50 x 50mm 5 9725	50 x 50mm 5 9720	50 x 50mm 5 9726	50 x 50mm 5 9724	50 x 50mm 5 9721	50 x 50mm 5 9707	50 x 50mm 5 9710	50 x 50mm 5 9706	50 x 50mm 5 9709	100 x 100mm 5 9700	100 x 100mm 5 9701	100 x 100mm 5 9702	100 x 100mm 5 9703	100 x 100mm 5 9704	100 x 100mm 5 9705	50 x 50mm 5 9712	50 x 50mm 5 9715	50 x 50mm 5 9716	50 x 50mm 5 9717	50 x 50mm 5 9714	50 x 50mm 5 9711



Material Codes

1 Rigid Plastic 2 Self Adhesive Vinyl 5 Miscellaneous

Landscape Sizes

F 200 x 200mm **Q** 600 x 450mm **U** 100 x 100mm **W** 900 x 600mm

Temporary Reflective Traffic Management Vehicle Marking



Magnetic
1400 x 140mm
5 6331



Self Adhesive 1300 x 100mm 5 6499 | Magnetic 1300 x 100mm 5 6520



Self Adhesive 1300 x 100mm 5 6519 | Magnetic 1300 x 100mm 5 6521



Magnetic
700 x 140mm
5 6336



Self Adhesive 800 x 275mm 5 6522 | Magnetic 800 x 275mm 5 6524



Magnetic
700 x 140mm
5 6337



Self Adhesive 800 x 275mm 5 6523 | Magnetic 800 x 275mm 5 6525

ECE 70 Plates

Aluminium plate with high grade retro-reflective yellow and fluorescent red finish. Manufactured to ECE 70, specifications applicable to all trucks from April 1996.



Aluminium
600 x 200mm
5 6348



Aluminium
300 x 200mm
5 6349



Aluminium
1200 x 200mm
5 6347

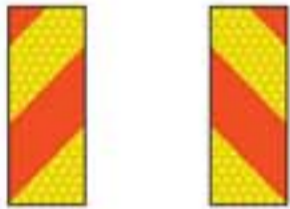

Aluminium
140 x 300mm
5 6343



Aluminium
140 x 300mm
5 6344



Aluminium
300 x 140mm
5 6345



Aluminium
1200 x 140mm
5 6340



Aluminium
300 x 140mm
5 6346



Aluminium
600 x 140mm
5 6341



Aluminium
600 x 140mm
5 6342

Vehicle Contour Marking

Vehicle contour marking has been mandatory requirement since July 2011. Highly reflective, extremely durable and coated with a suitably strong adhesive which complies with ECE 104



Colour	Curtain Sided	Code	Rigid-Sided	Code
Yellow Reflective	50m x 50mm	5 6353	12.5m x 50mm	5 6332
Red Reflective	50m x 50mm	5 6354	12.5m x 50mm	5 6334

Protruding Loads

Signs for marking overhanging and protruding loads from the sides, front and rear of vehicles, manufactured from 3mm PVC with non-reflective detail.



3mm Foam PVC
1520 x 300mm
5 6372

685mm

610mm

3mm Foam PVC
685 x 610mm
5 6370

3mm Foam PVC
1520 x 300mm
5 6371

Protruding Loads Information

The end of a load must be made clearly visible if the length of projection is between 1 and 2 metres. Marker boards are required if the load projects rearwards or forwards by more than 2 metres. Marker boards are required if there is over 305mm lateral projection on either side.

Vehicle Plates

Complies with BS AU 152 specifications for rear marking plates for vehicles. Manufactured from reflective aluminium.



1265 x 225mm
5 6295



1265 x 225mm
5 7142



1265 x 225mm
5 7140



1265 x 225mm
5 7144



525 x 250mm
5 6296



525 x 250mm
5 7141



525 x 250mm
5 7143



525 x 250mm
5 7145



Vehicle Inspections

Pre-drive vehicle checks can help companies to improve safety, comply with legislation and reduce maintenance costs by spotting potential faults early.

To view our full range of checklists, including vehicle inspections please see pages 131 - 135.

Gas Cylinder Signs



1 4440 E | 2 4440 E



1 4439 E | 2 4439 E



1 4430 U | 2 4430 U

Gas Cylinder Tags

- Matt PVC
- 80 x 150mm
- Double Sided
- Pack of 10
- Includes 150mm cable ties



5 4538



5 4539

Hazchem Placards 700 x 400mm - Reflective

When ordering these ready made Hazchem plates, advise the SPECIALIST ADVICE / TELEPHONE NUMBER you wish to display.

Petrol / Benzine



Aluminium 5 6358 | Self Adhesive 5 6359

Kerosene



Aluminium 5 6362 | Self Adhesive 5 6363

Diesel / Gas Oil



Aluminium 5 6360 | Self Adhesive 5 6361



Multi-Load Placards

Under the Carriage of Dangerous Goods by Road Regulations 1996, reflective placards displaying the Emergency Action Code in the upper sector must be displayed at the rear of the vehicle. *Specify your required action code and UN number when ordering



Reflective Aluminium 400 x 300mm 5 6365 | Reflective Self Adhesive 400 x 300mm 5 6366

Custom Hazchem Placard

This system allows you to create your own Hazchem or multi-load placard, produced to your exact specifications.

When ordering: specify the letters and numbers you require. Please note the letters to choose from are E, P, R, S, T, W, X and Z. The numbers range from 0-9

Select your hazard warning symbol from those shown on page 90

Specify the SPECIALIST ADVICE / TELEPHONE NUMBER you wish to display.

700 x 400mm - Reflective

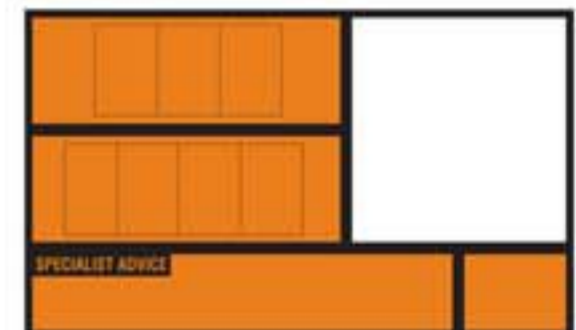

Aluminium 5 6238 | Self Adhesive 5 6239

Site Marking Placards

These signs should be used to highlight storage areas containing hazardous substances.



Aluminium 850 x 250mm 5 6267 | Self Adhesive 850 x 250mm 5 6268



Aluminium 850 x 250mm 5 6269 | Self Adhesive 850 x 250mm 5 6272



Aluminium 610 x 300mm 5 6259 | Self Adhesive 610 x 300mm 5 6373



Aluminium 610 x 300mm 5 6374 | Self Adhesive 610 x 300mm 5 6375

Embossed ADR Plates

0.8mm Stainless Steel - 400 x 300mm

Embossed hazchem plates, displaying the hazard indication number and UN number with reflective orange background to ADR specifications. Can be placed inside the placard holder (5 6285) on the front and rear of the vehicle.

Petrol / Benzine



5 6696

Kerosene



5 6698

Diesel / Gas Oil



5 6697

Alternative designs can be supplied, please call us and provide details for a quote – please note that due to the manufacturing process involved for embossed ADR plates and placards extended lead-times will apply.

We will advise when quoting.

Placard Holder



Designed to be used with multi-load placards, hazchem plates and vehicle plates. Manufactured from 1mm black powder coated stainless steel. Plates and placards are sold separately.

Black Stainless Steel 400 x 300mm 5 6285 | Black Stainless Steel 700 x 400mm 5 6286

Hazard Warning Vehicle Plate



Under ADR Regulations, plates must be displayed at the front of any vehicle carrying dangerous goods and at rear if dangerous goods are contained in packages.

Aluminium 400 x 300mm 5 6364 | Self Adhesive 400 x 300mm 5 6237 | Reflective Magnetic 400 x 300mm 5 6338

Plate Cover

Place a cover over the plate when no hazardous goods are on board.



ADR Fabric Cover 400 x 300mm 5 6328

Folding Vehicle Plates

Can be folded and locked in place when the vehicle is not carrying any hazardous goods.



Non - Reflective PVC 250 x 250mm 5 6699

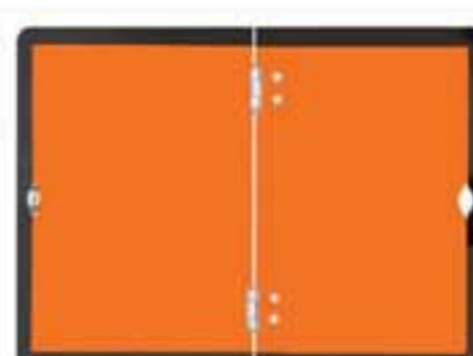

Reflective Aluminium 400 x 300mm 5 6327

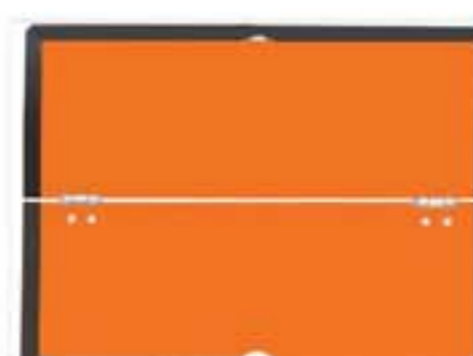

Reflective Aluminium 400 x 300mm 5 6700



Material Codes

1 Rigid Plastic 2 Self Adhesive Vinyl 5 Miscellaneous

Landscape Sizes

200 x 150mm 100 x 100mm

External Speed Restriction Stickers

A range of speed restriction / speed limit stickers to apply to a van, lorry or coach when they have a speed limiter fitted. Self-adhesive vinyl is easily applied to clean, dry surfaces.



Please be aware the road speed limits for this vehicle are

- 40 Single carriageways
- 50 Dual carriageways
- 60 Motorways

2 1808 E

Please be aware the road speed limits for this vehicle are

- 50 Single carriageways
- 60 Dual carriageways
- 70 Motorways

2 1809 E

I'm sticking to the speed limit
Please keep a safe distance

2 1816 E

LIMITED TO 30 MPH

2 1817 FU

LIMITED TO 40 MPH

2 1818 FU

LIMITED TO 45 MPH

2 1819 FU

LIMITED TO 50 MPH

2 1820 FU

LIMITED TO 56 MPH

2 1821 FU

LIMITED TO 58 MPH

2 1822 FU

LIMITED TO 60 MPH

2 1823 FU

LIMITED TO 68 MPH

2 1824 FU

LIMITED TO 70 MPH

2 1825 FU

External Vehicle Stickers

These stickers should be applied to the outside of a van, lorry or coach to highlight safety warnings. Self-adhesive vinyl is easily applied to clean, dry surfaces.

Warning
This vehicle is left hand drive

Take care when passing as drivers view is limited

2 1811 E

Warning
Heavy Vehicles

Leave extra space due to increased braking distance

2 1814 E

Danger
Vehicles turning

Do not undertake on the inside of this vehicle

2 4046 E

Warning
Tailgate is operated remotely

Do not stand behind trailer

2 1813 E

This vehicle is fitted with a tracker

2 1826 E

No tools stored in this vehicle overnight

2 1723 E

Keep clear
Disabled access required for this vehicle

2 1815 E

This vehicle records images for the purpose of crime prevention and road safety

2 1806 E

Warning
Cyclists beware of passing this vehicle on the inside

2 1807 E

Warning
This vehicle makes wide turns

2 1812 E

Please leave enough room for these doors to fully open

2 1810 E

Warning
Tiredness can kill

Please take a break when needed

2 1830 DE

WARNING THE DRIVER MAY NOT SEE YOU IN THIS AREA

Self Adhesive Vinyl 1000 x 50mm 5 1833

This sign should be displayed on the sideguards of a HGV to comply with the direct vision standard for vehicles entering and operating in Greater London. The direct vision standard is a HGV safety permit for vehicles with a gross weight of over 12 tonnes.

Internal Vehicle Stickers

Remind drivers of their legal duties and responsibilities with this range of dashboard stickers.

England & Wales Speed Limits

Vehicle Type	Single Carriageway	Dual Carriageway	Motorway
Cars & Motorcycles	30	60	70
Cars Towing	30	50	60
Goods Vehicles	30	50	60
Goods Vehicles	30	50	60

2 1828 DE

Internal dashboard stickers including: SLOW DOWN, EYES ON THE ROAD, NO MOBILE PHONES, NO DRUGS/ALCOHOL, SEATBELT, SECOND GAP, NO VAPING, NO SMOKING.

2 1827 V

No mobile phone use while driving

1 3613 FN
2 3613 F
8 3613 E

No vaping in this vehicle

2 3059 GA

Stay alive! Don't text and drive

2 3670 A

No smoking in this vehicle

2 3008 GA

Scotland Speed Limits

Vehicle Type	Single Carriageway	Dual Carriageway	Motorway
Cars & Motorcycles	30	60	70
Cars Towing	30	50	60
Goods Vehicles	30	50	60
Goods Vehicles	30	40	50

2 1829 DE

Internal dashboard stickers including: NO SMOKING, Do not use hand held mobile phones whilst driving, It is against the law to drive this vehicle whilst under the influence of either drugs or alcohol, Seatbelts must be worn at all times when this vehicle is moving, Vehicle inspections must be carried out daily.

2 3669 S

No smoking

1 3017 BFN
2 3017 BF
8 3017 BF

Sheet of 6 Self Adhesive Vinyl 75mm Dia 5 3040

Rolls of Labels

Roll of 100 Self Adhesive Vinyl 50 x 50mm 5 9706

Roll of 100 Self Adhesive Vinyl 75mm Dia 5 9763

Speed Restriction Signs



Car parks on private land are managed using the laws of contract or trespass, whilst car parks operated by local councils are generally regulated by law. Typically, a principle sign will be displayed near the entrance to the car park describing who the car park is for, and if there are time or speed limits and details of any charges or free periods that may apply. Additional signage in and around the car park may provide more information relating to height restrictions, traffic flow and any designated parking bays.



1 7501 **N**
6 7501 **N**



1 7502 **N**
6 7502 **N**



1 7503 **N**
6 7503 **N**

Directional Signs



1 7535 **Q**



1 7536 **Q**



1 7537 **Q**



1 7538 **Q**



1 7543 **Q**

Ideal for displaying temporary messages, see page 113 for signage stanchions



1 7549 **N**
6 7549 **N**



1 7553 **N**



1 7598 **FN**



1 7512 **Q**
6 7512 **Q**



1 7513 **Q**
6 7513 **Q**

Information & Restrictions



1 7575 **GM**



1 7576 **GM**



1 7566 **GM**



1 7583 **GM**



1 7683 **GM**
2 7683 **GM**



1 7078 **L**



1 7079 **L**



1 7088 **L**



1 7063 **KQ**



1 7574 **KQ**



1 7582 **K**



1 7066 **KQ**



1 7568 **KQ**



1 7534 **K**



1 7798 **K**

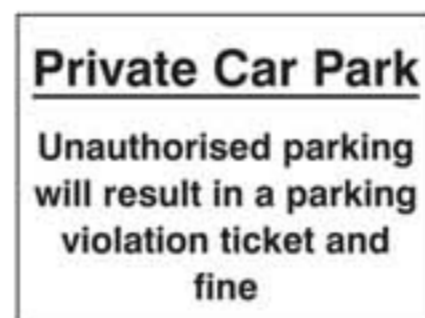

1 7797 **K**



1 7848 **HK**
6 7848 **HK**



1 7606 **KQ**
6 7606 **K**

Way Finding



1 7594 **K**



1 7595 **K**

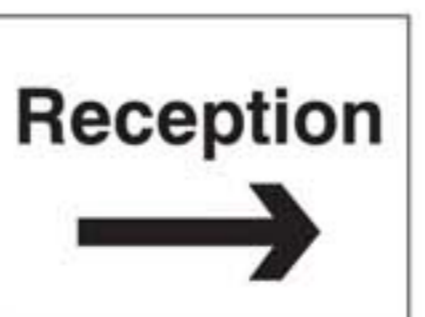

1 7596 **K**



1 7597 **K**



1 7579 **GM**



1 7018 **GL**
2 7018 **GL**



1 7021 **GL**
2 7021 **GL**



Our suspended frames are supplied with a suspension kit for fitting. They're the perfect solution for way finding signs.

Colour	300x100mm	450x150mm
Grey	5 8681	5 8680
White	5 8700	5 8701

Material Codes

1 Rigid Plastic 5 Miscellaneous 8 Quick Fix
2 Self Adhesive Vinyl 6 Aluminium

Landscapes Sizes

B 80 x 80mm E 200 x 150mm G 300 x 100mm K 400 x 300mm M 600 x 200mm Q 600 x 450mm U 100 x 100mm
D 150 x 100mm F 200 x 200mm H 300 x 250mm L 450 x 150mm N 400 x 400mm S 200 x 75mm V 300 x 150mm

Portrait Sizes

A 75 x 100mm
E 150 x 200mm

Car Park Signage

Verge Signs 450 x 150mm - 2mm Aluminium sign supplied on a 800mm pole

A quick and easy solution for parking and information signage. Can be simply sunk into the grass verge using the pole spike for temporary use or can be set into concrete for extra stability and permanent fixtures. When ordering customised verge signs please state the message, logo or number you wish to display.

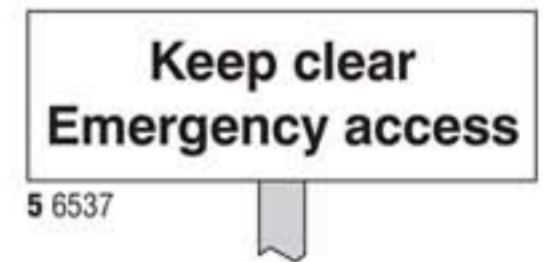
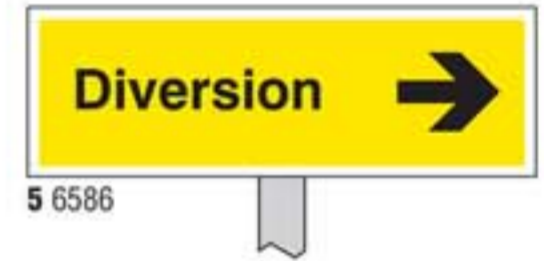
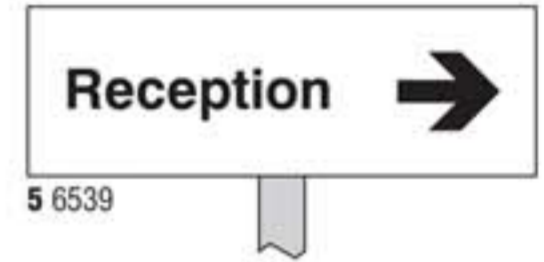

Custom Verge Signs

If you don't see the message you require, we can also supply custom verge signs in alternative sizes or with any message you may require. We can also add logos, images or reflective material to the sign to maximise impact. If you have a specific requirement please contact us and provide the relevant details and we will be happy to provide you with a competitive quote.



Electric Vehicle Parking

Raise awareness of the correct use of electric car charging points - identify location, and prevent unauthorised vehicles from parking in spaces specifically reserved for the charging of electric vehicles. Easily identifiable using the official DoT (Department of Transport) symbol and in green to highlight the benefits to the environment.

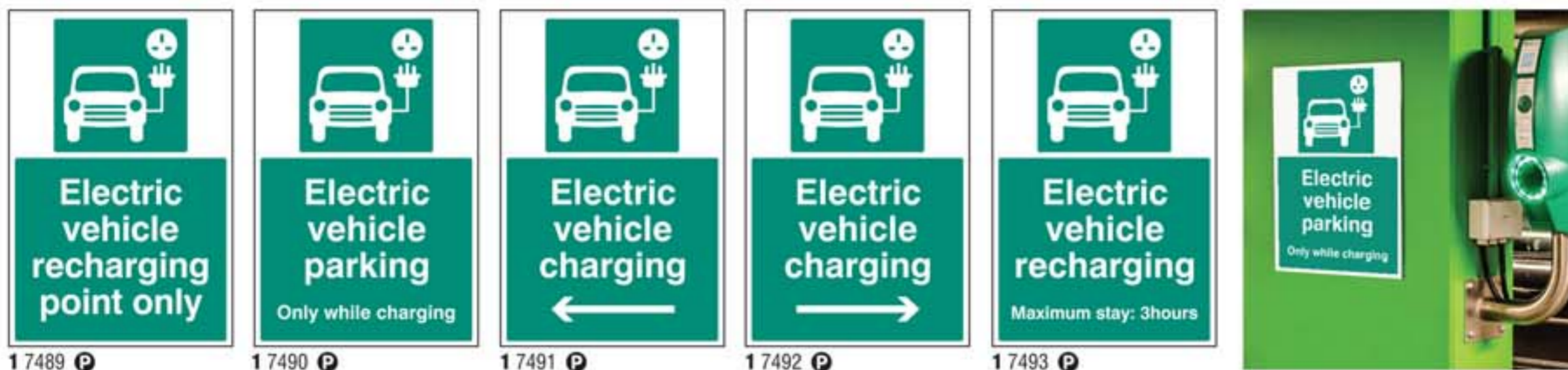

Pavement Sign

This eco-friendly, portable, high performance sign is ideal for pavement and forecourt messages and promotions. Manufactured from durable aluminium and recycled plastic. These pavement signs give off a perfect display in all types of weather. It has a large display area of 460 x 820mm on aluminium which is securely locked into the base with a blue wedge. The base provides an excellent ballast and has been tested in winds over 70mph.

Standard product has a single sided display. Contact us for a quote if you require a double sided display. Recycled PVC Base and Aluminium - 465 x 867 x 540mm (W x D x H) - Weight: 8.9kg.



Cone Signs

Reflective Polypropylene - 600 x 450mm
Use with 750mm / 1000mm cones (not included)



Custom Cone Sign

Our custom cone sign is an ideal solution for car park or roadside messages.

To customise this sign simply supply the message, logo or any other information required when ordering.



Our full range of cone signs are on page 111.

Temporary Speed Bump Signs

This range of signs help to slow traffic to the required speed limit. Display inside a metal sign frame found on page 113.



Bird Deterrent Spikes

Pack of 3 Polycarbonate Spikes - 333 x 90mm
Birds often find refuge in parking lots and perching on street lights, creating a mess on the cars and the surrounding area. Bird deterrent spikes are a simple but effective solution to prevent birds from perching and nesting. Manufactured from transparent polycarbonate these spikes are designed to blend in and are rounded so not to harm birds or maintenance personnel. Spikes can be fitted by the use of screws or with double sided weather resistant tape.



5 8107

Acrylic Tape

Double sided high bond adhesive tape



25mm x 33m

5 8105

Material Codes

1 Rigid Plastic 6 Aluminium
5 Miscellaneous

Landscape Sizes

K 400 x 300mm
Q 600 x 450mm

Portrait Sizes

P 400 x 600mm

Material Information

Deciding on your sign message is only the first step. When ordering a sign, thought should also be given to where that sign is going to be displayed. For more information on our most popular materials and the locations they are most suitable for see page 4-5.

Security

Polite Notice



1 7106  
2 7106  

Do you want this sign with a different message? Contact us for a quote

CAR PARK

The management cannot accept responsibility for loss or damage of property or vehicles in this car park.



1 7592  
7 7592 



1 7532  

SECURITY NOTICE

These premises are under constant surveillance

1 1704 
2 1704 



1 7533  *State value

Users of this car park do so at their own risk.

The management will not accept responsibility for any damage, accidents or losses.

1 7540  
6 7540  



1 7539  



Security Signs

For our extensive range of CCTV and security signage please refer to pages 80-81.

Alternative Signs

To create your own bespoke message please contact us for a quote or refer to page 148 for more information.



Maximum Headroom Highlighting



Reflective Aluminium
1200 x 150mm
5 6496

State headroom required



Reflective Aluminium
600 x 150mm
5 6497



Reflective Aluminium
600 x 150mm
5 6498

Headroom Bollard

Safely and effectively warn drivers of restricted height conditions ahead at car parks, buildings or facilities with restricted clearance.

Lightweight polyethylene construction minimises the risk of damage to vehicles.

Easily installed
No sharp edges
Reflective for clear visibility
2 x Suspension chains (2 x 2m)

Polyethylene
950 x 100mm Diameter
5 6323



Free Standing Car Park Signs

Rigid Plastic - 600 x 450mm - Complete with steel Frame and Clips



5 8528



5 7796



5 8527



Bicycle Parking Signs



1 7694 



1 7693 



1 7695 



1 7692 



Wall Mounted Bike Rack

This individual wall mounted bike rack is ideal for areas with limited space. Providing security and organisation to bicycle parking.

Zinc plated steel construction (16mm dia tube). Suitable for bicycles up to tyre width 50mm. Adjustable through 180 degrees. Wall mounting – fixings included. Fully assembled, compact and flexible design. Size: 335 x 90 x 285mm (H x W x D)

5 8059

Free Standing Bike Rack

A range of compact bike racks ideal for domestic bicycle parks, housing estates, schools etc.

Zinc plated steel construction (16mm dia tube). Suitable for bikes with tyre width of up to 50mm. Accessible from both sides. Fully assembled, supplied with ground fixings.

Description	Code
Rack for 3 (HxWxD): 255 x 720 x 330mm	5 8056
Rack for 4 (HxWxD): 255 x 1025 x 330mm	5 8057
Rack for 5 (HxWxD): 255 x 1340 x 330mm	5 8058



Ice Detector Signs

Reduce the risk involved with costly slip and fall accidents on your property by installing our Ice Detector Signs. These Ice Detector signs are a early warning system that can be used in any outdoor area, including car parks, railway stations, depots, roads, hospitals, retail locations, airports, walkways and outdoor workplaces. These signs incorporate a temperature sensitive blue reflector, which gradually revolves into sight when the temperature reaches 2°C and by -1°C is in full view. It requires no power and is virtually maintenance free.

The signage system will lower the personal injury financial risk involved with costly accidents and helps make up part of the employers' Duty of care' charter to their employees. A simple visual indicator of imminent freezing conditions. The Ice Detector Sign has a three stage indication process utilising a temperature sensitive blue reflector, which revolves into place when temperatures start to move below 2°C.

As illustrated on information panel 5 8199, when the temperature is above 2°C, the grey indicator will show that conditions are normal. As the temperature drops, the reflector will transition to show that conditions are becoming colder and the threat of potential freezing conditions are therefore a possibility. When the temperature drops below -1°C then the reflector display will be fully blue.

Our signs are manufactured from 3mm thick aluminium composite, making them lightweight and durable. Each sign is equipped with channelling on the rear for post mounting. They should be positioned in a way to ensure they are clearly seen at eye level, to provide the quickest indication of the temperature outside of any building or car parking facility when entering or exiting the building.



165mm Diameter Ice Detector mounted on 3mm Aluminium Composite
300 x 500mm
5 8197



165mm Diameter Ice Detector mounted on 3mm Aluminium Composite
300 x 500mm
5 8198

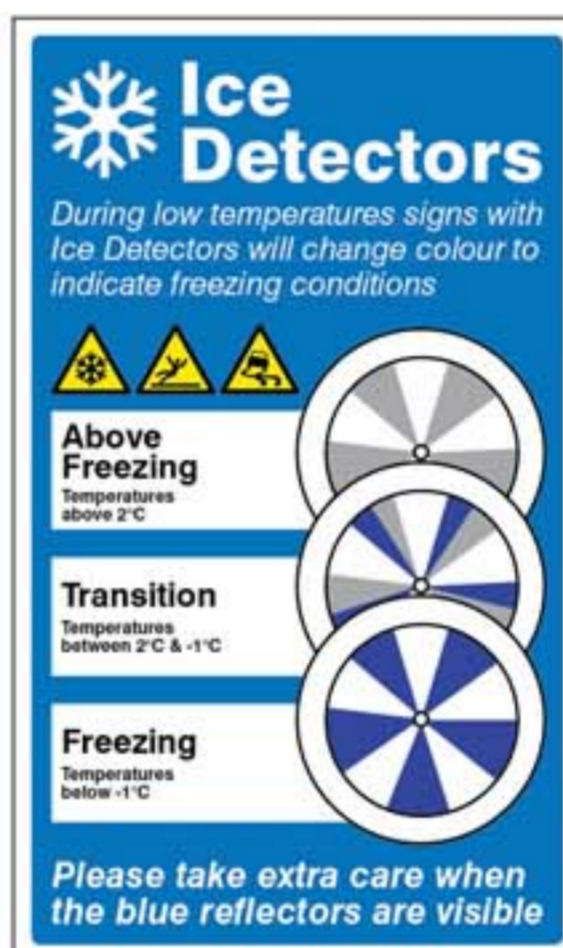

Information Panel (Ice Detector not Included)
3mm Aluminium Composite
300 x 500mm
5 8199



Stencils

Laser cut clear PET (polyethylene) stencils – 100% recyclable, high chemical resistance – allowing them to be re-used after numerous paint applications. Hard wearing with high impact strength.

Bespoke designs can be created (maximum size of 600 x 900mm) – contact us with details for a quote. Ideal for repeating key safety messages throughout car parks and warehouses by simply painting over the stencil at required locations.



600 x 400mm
5 9662



600 x 400mm
5 9660



600 x 400mm
5 9602



300 x 400mm
5 8441



0 - 9 (10 piece kit) 5 9642
A-Z (26 piece kit) 5 9643



0 - 9 (10 piece kit) 5 9640
A-Z (26 piece kit) 5 9641



600 x 400mm
5 9537



600 x 400mm
5 9649



600 x 400mm
5 9585



300 x 400mm
5 9648



A-Z and 0-9 (36 piece kit) 5 9646



600 x 400mm
5 9589



600 x 400mm
5 9612



600 x 400mm
5 9613



600 x 400mm
5 9536



400 x 300mm
5 9647

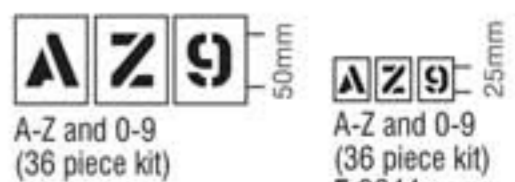

A-Z and 0-9 (36 piece kit) 5 9645

A-Z and 0-9 (36 piece kit) 5 9644

Material Codes

- 1 Rigid Plastic
- 2 Self Adhesive Vinyl
- 5 Miscellaneous
- 6 Aluminium
- 7 PET

Landscape Sizes

- G 300 x 100mm
- K 400 x 300mm
- M 600 x 200mm
- Q 600 x 450mm

Portrait Sizes

- H 250 x 300mm
- P 400 x 600mm

Material Information

For information on our most popular materials and the locations they are most suitable for see page 4-5.

RA1 & R2 Traffic Signs

From 1st July 2013, any permanent sign directing traffic as listed in the Traffic handbook must be CE Marked.

This means road traffic signs erected on a public highways need to be manufactured in accordance with the CE Marking Standard. All of our permanent road traffic signs are manufactured in accordance with Chapter 8 & TSRGD guidelines. Our reflective material meets the specification of classes RA1 (for temporary use) and R2 (for permanent siting) under BS EN 12899. All signs on this page are supplied complete with channelling for post mounting.

Fig. 670 600mm Diameter RA1 R2 5 6566 5 7708	Fig. 670 600mm Diameter RA1 R2 5 6567 5 7709	Fig. 670 600mm Diameter RA1 R2 5 6568 5 7710	Fig. 670 600mm Diameter RA1 R2 5 6569 5 7711	Fig. 670 600mm Diameter RA1 R2 5 6570 5 7712	Fig. 616 600mm Diameter RA1 R2 5 6573 5 7715	Fig. 601.1 750mm Octagon RA1 R2 5 7824 5 7724
Fig. 612 600mm Diameter RA1 R2 5 6575 5 7717	Fig. 613 600mm Diameter RA1 R2 5 6574 5 7716	Fig. 615 600mm Diameter RA1 R2 5 7819 5 7719	Fig. 625.1 600mm Diameter RA1 R2 5 7823 5 7723	Fig. 652 300 x 450mm RA1 R2 5 7831 5 7731	Fig. 811 700 x 800mm RA1 R2 5 7838 5 7738	Fig. 965 395 x 430mm R2 5 7454
Fig. 606 600mm Diameter RA1 R2 5 6562 5 7704	Fig. 606 600mm Diameter RA1 R2 5 6561 5 7703	Fig. 610 600mm Diameter RA1 R2 5 6559 5 7701	Fig. 610 600mm Diameter RA1 R2 5 6560 5 7702	Fig. 611.1 600mm Diameter RA1 R2 5 7821 5 7721	Fig. 955 300mm Diameter RA1 R2 5 7842 5 7742	Fig. 956 300mm Diameter RA1 R2 5 7843 5 7743
Fig. 602 600mm Triangle RA1 R2 5 7829 5 7729	Fig. 557.1 600mm Triangle RA1 R2 5 7852 5 7752	*State height when ordering Fig. 530A 750mm Triangle RA1 R2 5 6595 5 6594	Fig. 544 600mm Triangle RA1 R2 5 7893 5 7793	Fig. 545 600mm Triangle RA1 R2 5 7894 5 7794	Fig. 521 600mm Triangle RA1 R2 5 7858 5 7758	Fig. 522 600mm Triangle RA1 R2 5 7859 5 7759
Fig. 517 600mm Triangle RA1 R2 5 7864 5 7764	Fig. 517 600mm Triangle RA1 R2 5 7865 5 7765	Fig. 544.1 600mm Triangle RA1 R2 5 7892 5 7792	Fig. 512 600mm Triangle RA1 R2 5 7860 5 7760	Fig. 512 600mm Triangle RA1 R2 5 7861 5 7761	Fig. 562 600mm Triangle RA1 R2 5 7869 5 7769	Fig. 544.2 600mm Triangle RA1 R2 5 7891 5 7791
				Permanent road signs must be CE marked All of our R2 reflective signs are supplied complete with CE marking. All our signs are manufactured from 3mm traffic grade Aluminium Composite, a lightweight and weather resistant material ideal for external use. Aluminium Composite has no scrap value and therefore the risk of theft is reduced.		
Fig. 661A 320 x 250mm RA1 R2 5 7832 5 7732	Fig. 660.9v 355 x 275mm RA1 R2 5 7450 5 7451	Fig. 660.9v 355 x 275mm RA1 R2 5 7452 5 7453	Fig. 966 535 x 230mm R2 5 7455			

Need a different traffic sign or symbol? Contact us and we can provide you with a quote.



RA1 Zintec Traffic Signs

How well signs are seen dictates how drivers react. That's why the brightness and clarity of signage is so important. Manufactured using engineering grade (Class RA1) reflective sheeting applied on to 20/22 gauge Zintec plate. These traffic management signs are designed for use with road sign frames as shown on page 113.

					
Class RA1 750 x 750mm Fig. 610 5 7946	Class RA1 600mm 750mm Fig. 562 5 8071 5 7920	Class RA1 600mm 750mm Fig. 554 5 8073 5 7922	Class RA1 600mm 750mm Fig. 7001 5 8075 5 7924	Class RA1 600mm 750mm Fig. 557 5 8074 5 7923	
					
Class RA1 600 x 450mm 1050 x 750mm Fig. 7018 5 7950 5 7901	Class RA1 600 x 450mm 1050 x 750mm Fig. 7018 5 7951 5 7902	Class RA1 600 x 450mm 1050 x 750mm Fig. 7018 5 7952 5 7903	Class RA1 600 x 450mm 1050 x 750mm Fig. 7010.1 5 7956 5 7907	Class RA1 600 x 450mm 1050 x 750mm Fig. 7010.1 5 7957 5 7908	Class RA1 600 x 450mm 1050 x 750mm Fig. 7014 5 7958 5 7909
					
Class RA1 600 x 450mm 1050 x 750mm Fig. 2702 5 7953 5 7904	Class RA1 600 x 450mm 1050 x 750mm Fig. 2702 5 7954 5 7905	Class RA1 600 x 450mm 1050 x 750mm Fig. 2702 5 7955 5 7906	Class RA1 600 x 450mm 1050 x 750mm Fig. 7011 5 7962 5 7913	Class RA1 600 x 450mm 1050 x 750mm Fig. 7301 5 7963 5 7914	Class RA1 600 x 450mm 1050 x 750mm Fig. 7010.1 5 7964 5 7915
					
Class RA1 600 x 450mm Fig. 7010.1 5 7959	Class RA1 600 x 450mm 1050 x 750mm Fig. 7010.1 5 7960 5 7911	Class RA1 600 x 450mm 1050 x 750mm Fig. 7010.1 5 7961 5 7912	Class RA1 600 x 450mm 1050 x 750mm Fig. 7302 5 7965 5 7916	Class RA1 600 x 450mm 1050 x 750mm Fig. 511 5 7966 5 7917	Class RA1 600 x 450mm 1050 x 750mm Fig. 511 5 7967 5 7918

RA1 Zintec Supplementary Plates

These supplementary plates are for use with the frame 5 8761 (see page 113) - Additional plates available on request.

				
Class RA1 850 x 355mm Fig. 7000.1 5 7929	Class RA1 850 x 355mm Fig. 7000.1 5 7930	Class RA1 850 x 355mm Fig. 7000.1 5 7934	Class RA1 850 x 355mm Fig. 7000.1 5 7935	Class RA1 850 x 355mm Fig. 7000.1 5 7948

What is Zintec?

Zintec is a durable, rust resistant steel sheet that is covered in a thin layer of zinc using an electromagnetic process, making it extra strong and providing a smooth finish. As a result Zintec proves a great option for temporary traffic signs when you know they will spend time being stored or transported between use.

Custom RA1 Zintec Signs and Supplementary Plates

We can manufacture zintec signs and supplementary plates with custom designs and wording so if you can't find your message of choice please advise us and we will produce to your specifications. For alternative sizes please contact us for a quote.

		
	600 x 450mm 5 8205 1050 x 750mm 5 8204	600mm 5 8207 750mm 5 8206
		
	850 x 355mm 5 8069	

Lollipop Sign

Composite reflective sign on a 1500mm collapsible pole. Ergonomic handle, rubber feet and storage bag. Ultra compact, unique one-piece folding design.



Description	Diameter	Material	Pole Length	Code
Stop / Go	600mm	Reflective Composite	1500mm	5 8089
Stop - Works	450mm	Reflective Composite	1500mm	5 8090
Stop - Children	450mm	Reflective Composite	1500mm	5 8091

Reflective Signs

Available on various materials (aluminium, zintec & aluminium composite) with a choice of reflective finish. RA1 reflective (engineering grade) for temporary traffic signs.



Class	Reflective Material	Material	Usage
RA1	Engineer Grade: Lower reflectivity level sheeting, lower cost	20 / 22 Gauge Zintec Plating or 3mm Traffic: Aluminium Composite	Temporary Traffic Signs
R2	High Intensity Prismatic: Retains a high reflectivity level over time	3mm Traffic Dibond: Aluminium Composite	Permanent Traffic Signs

Re-Flex Frame

The Re-Flex QuickFit Frame is a plastic sign frame that is compatible with our pre-drilled Re-Flex Signs. The modular design enables workers to quickly assemble signage on site. The system removes the need for stocking multiple frame shapes and sizes because interchangeable signs can be installed on the same frame.

Four antiluce droplock fasteners make changing signs fast and simple and eliminate the need for wingnuts, road frame clips and other additional small accessories which get lost and / or damaged.

Due to the frame being an all-plastic design it will not conduct electricity, corrode over time and removes the risk of theft for scrap metal. The frame is made using recycled plastic materials and can be recycled at end of life.



Highly resistant to wind:
 Category C (19 mph) winds without ballast
 Category B (39 mph) winds with a 9kg weight
 Ultra-durable sign frame is resistant to cracking
 Lightweight and stackable 3.3kg design reduces weight and space taken up in works vehicles
 Collapsed Frame Dimensions: H 935 x W 800 x D 35mm
5 7470



Improved Design

Please note:
 Re-Flex frame and sign faces are sold separately.

Rectangular Re-Flex Signs 600 x 450mm - Pre-drilled 3mm Polypropylene with RA1 Engineering Grade Reflective Face

 5 7561	 5 7563	 5 6431	 5 6450	 5 6471	 5 7608
 5 7526	 5 7571	 5 6438	 5 7590	 5 7525	 5 7607
 5 7528	 5 7508	 5 7509	 5 7510	 5 6426	 5 6427
 5 6452	 5 6419	 5 7480	 5 7481	 5 7482	 5 7788

Triangular Re-Flex Signs

750 x 850mm (H x W) - Pre-drilled 3mm Polypropylene with RA1 Engineering Grade Reflective Face

 5 7483	 5 7484	 5 7485	 5 7486	 5 7487
-------------------	-------------------	-------------------	-------------------	-------------------

Re-Flex Standing Dimensions

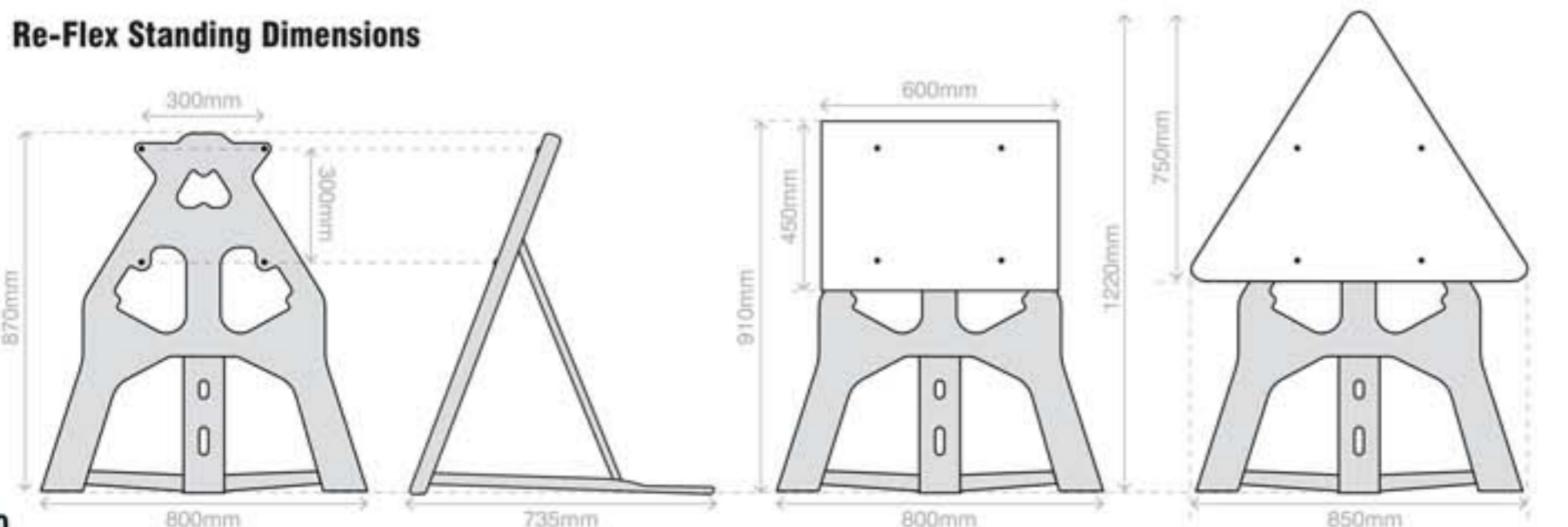

Sand Bags



These sandbags are treated to protect them against ultra violet light, giving them a longer life span when exposed to the sun.

Ideal for more demanding temporary uses such as flood protection and as ballast for stabilising road signs, temporary traffic lights etc.

This type of heavy duty sandbag is designed for multiple re-use so can have long term cost benefits.

Empty bag: 34cm x 65cm
 Filling capacity: 15kg of sand.
 Pack of 50 - Empty
5 8690

Reflective Cone Signs

Lightweight Reflective Polypropylene cone sign for use on a 750mm / 1000mm traffic cone (not included). The fixing loops on the rear of the sign allow quick and easy attachment to cones. A perfect solution for providing temporary messages on site.



600 x 450mm Rectangular Cone Signs



Custom Cone Signs

Customise these signs by quoting the relevant code and supplying the required message / image.



750 x 750mm Square Cone Signs

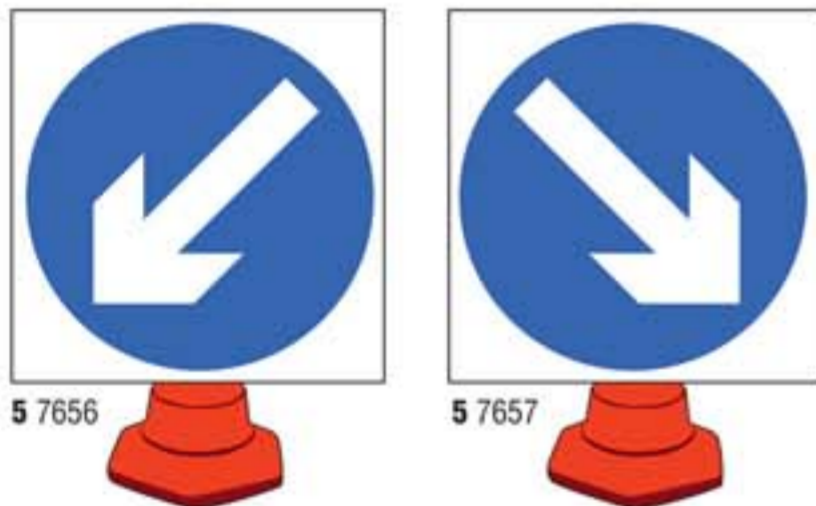

750 x 850mm Triangular Cone Signs



Vehicle Warning Triangle

EC approved reflective warning triangle to advise road users of a breakdown or hazard ahead. Supplied in a handy plastic storage case for ease of storage.



Dimensions: 440x30x400mm
5 7799

Traffic Cones

Available in a choice of 3 sizes, can be stacked to save space.

Manufactured from recycled materials. Supplied complete with a reflective sleeve. These cones conform to BS EN 13422:2004.

Height	Code
500mm	5 7663
750mm	5 7664
1000mm	5 7665



Chapter 8 Roll-up Sign Kit

A compact, lightweight pack of eight reflective roll-up signs, as required for road works under Chapter 8 of The Traffic Signs Manual. This kit saves space and weight compared to rigid signs and frames. Supplied in two storage bags for easy transportation. The kit also includes site layout guidance from the "Safety at Street Works" Red Book.

Kit includes tripods and the following 750mm signs:

- 2 x Men at Work
- 2 x Men at Work - End
- 2 x Keep Right
- 1 x Road Narrows Offside
- 1 x Road Narrows Nearside

- Wind Tunnel tested to 60mph
- Weight: 30kg (3.7kg per sign)

Storage Dimensions (HxWxD):
500 x 1500 x 300mm
5 7669



Fold-up Road Signs

These signs have been designed specifically for short to medium term work-zones, they are compact and easy to store and transport when collapsed. Tripods are manufactured from rust-proof aluminium and all metalwork has bright zinc plating to prevent corrosion. The sign faces are constructed from reinforced grey PVC with a reflective material protected by a clear PVC top layer for additional durability. These signs have a ground clearance of 300mm (as specified by UK Road Sign Legislation).

Triangular One piece unit



Size Code
600mm 5 6555
750mm 5 7645



Size Code
600mm 5 7634
750mm 5 7646



Size Code
600mm 5 6556
750mm 5 7647

Bespoke Fold-up Signs

Alternative sizes and sign faces are available upon request and can be printed with any road sign design from UK or EU specification.

Please allow 2 - 3 weeks for delivery of bespoke signs.



Triangular with Space for Supplementary Text



These fold up signs are supplied with your selected sign message and with space below to attach your supplementary text (sold separately) – choose from the options to the right and simply attach to the fold up sign using the press studs.



Size Code
600mm 5 6545
750mm 5 7642



Size Code
600mm 5 7638
750mm 5 7639



Size Code
600mm 5 7600
750mm 5 7635

Supplementary Text Rust proof press studs

End

5 6546

Grass cutting

5 6547

Overhead Works

5 6548

Tree cutting

5 6550

Hedge cutting

5 6551

Road sweeping

5 6553

Gully emptying

5 6554

Your Message

5 7682

Triangular Set Up

Lightweight and easy to erect. These signs fold up for compact storage and transportation purposes.

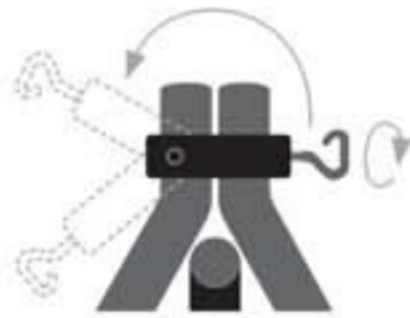

The shackle at the top of the tripod locks front legs open and keeps the sign face taut



The press stud strap holds the sign face neatly when rolled up for easy transportation and storage

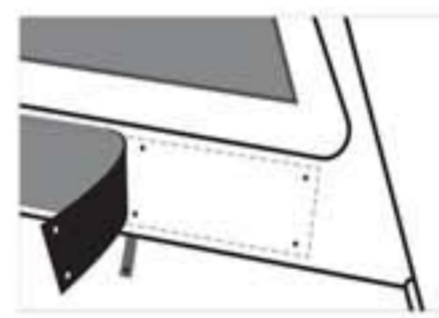

Six rustproof press-studs enable easy fixing of interchangeable supplementary text or variants



Rectangular Two piece unit



600 x 450mm
5 7680



600 x 450mm
Includes reversible arrow
5 7628



Give way to oncoming vehicles

600 x 900mm
5 7678

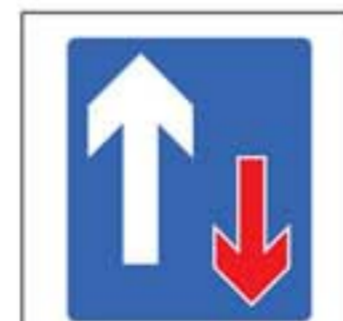

Priority over oncoming vehicles

600 x 900mm
5 7679



1050 x 750mm
5 6558

Circular Two piece unit



600 x 600mm
5 7631



600 x 600mm
5 7661

Circular with Reversible Arrow



The reversible option on this fold up sign allows the arrow position to be changed and allows one sign to be used for either a keep left or keep right message. The arrow can be removed and attached using the rust free press studs to ensure the correct direction is shown. An economical and flexible solution to traffic management.

750 x 750mm
5 7681

Rectangular / Circular Set Up

Lightweight and easy to erect. These signs fold up for compact storage and transportation purposes.



At the top of the sign panel there is a concealed hook on springs that provides tension to keep the sign taut.

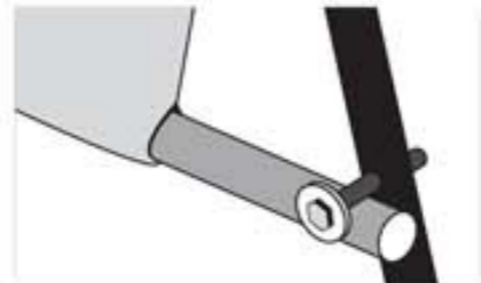

The bar at the bottom of the sign panel extends to hook under the spacer bolts on the front legs of the tripod.



A hook on the back leg of the tripod enables a ballast to be used in volatile conditions



Single Sided Sign Frames Grey Zinc Painted Steel

Sign frames include a 300mm ground clearance to meet recommendations for UK road sign regulations.

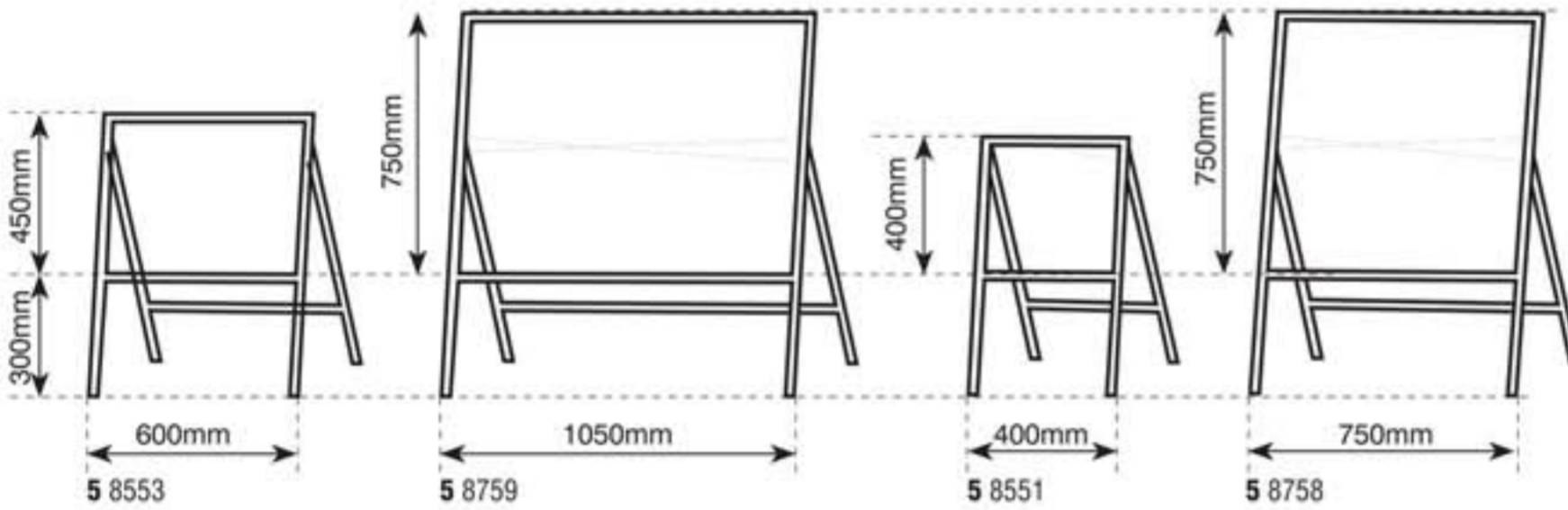
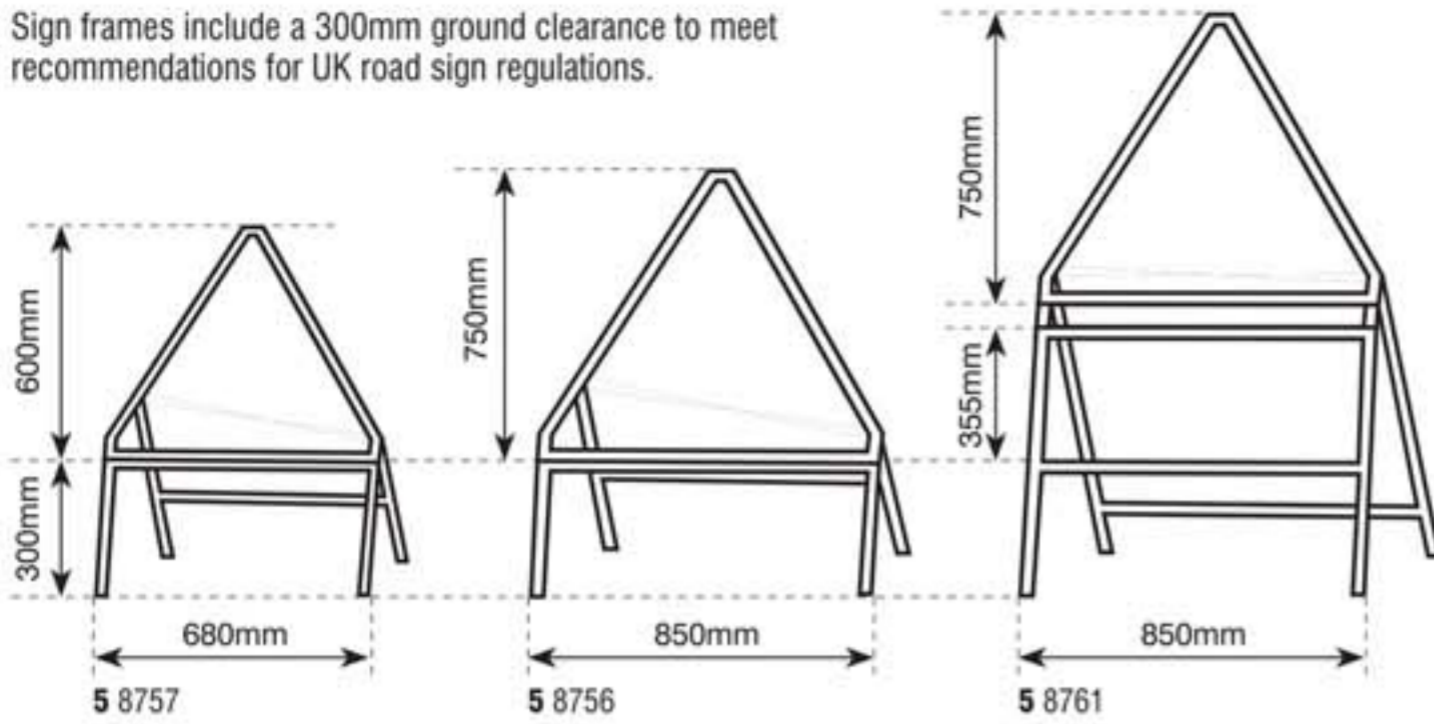

Road Frame Clip



Keep signs securely in the frame with our Road Frame Clips. Zinc plated steel for protection against corrosion. Minimum recommended number of clips per frame is four.
5 8755

Double Sided Sign Frame

This robust double-sided frame is an ideal solution for temporary outdoor signs in car parks, construction sites, event sites and workplaces.

Manufactured from angle iron mild steel with grey zinc coating to protect from corrosion this sign frame is designed to hold two 600 x 450mm signs (one either side) for maximum awareness.

We recommend the use of at least four road frame clips per sign (sold separately)

Iron mild steel with grey zinc coating
5 8550

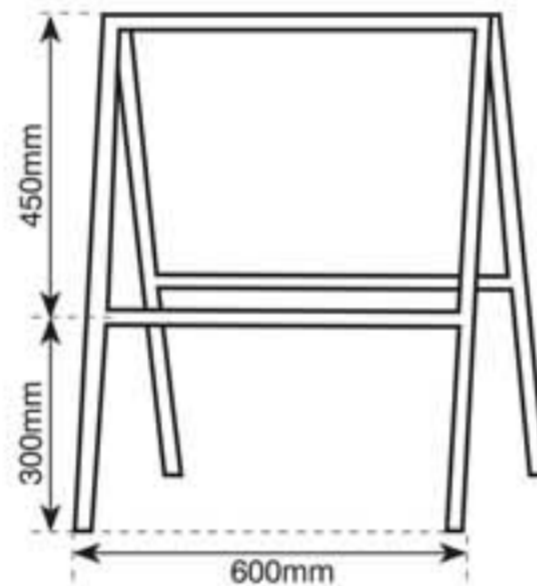

Tamtorque Clamps & Driver



Designed to give a quick and reliable fix to round, square or hexagonal posts every time and can be easily reused and readjusted.

No need to cut the band to size which means no sharp edges that could snag or cut. Manufactured from strong stainless steel with a hardened tamper resistant screw with a unique seven sided socket. These clamps can only be tightened or released with a tamtorque driver.

70-100mm Dia: 5 8772 190-250mm Dia: 5 8780
100-130mm Dia: 5 8774 Tamtorque Driver: 5 8770
130-190mm Dia: 5 8778

Sand Bags

These woven sandbags are ideal for more demanding temporary uses such as flood protection, defensive walls and as ballast for stabilising road signs, temporary traffic lights, and barriers for traffic management. This heavy duty sandbag is designed for multiple re-use so can have long term cost benefits.

Empty Dimensions: 340 x 650mm
Filled Weight: 15kg
Pack of 50 x Empty Sand Bags
5 8690



Grey Steel Posts

Grey painted steel pole for sign attachment available in a range of different lengths and diameters.

76mm Diameter
3.6 meter long: 5 8684
3.0 meter long: 5 8678
2.5 meter long: 5 8675
1.75 meter long: 5 8688

50mm Diameter
3 meter long: 5 8769
2.5 meter long: 5 8676
1.5 meter long: 5 8800



Sign Fixings

For more sign fixing options and accessories see pages 142-143



Base Plate

Recommended for secure and level anchoring of posts.

Install this base plate approximately 600mm below the surface and tighten the post to create an extra stable post. Base plate is Zinc coated steel.



Steel
50mm Diameter
5 8699

Stainless Steel
76mm Diameter
5 8686

Post Caps

Grey plastic cap, which fits onto the end of a post for a professional looking finish.

Grey Plastic
50mm Diameter
5 8750

Grey Plastic
76mm Diameter
5 8685



Non-Reflective Site Traffic Signs

1 7567 N	1 7504 N 6 7504 N	1 7503 N 6 7503 N	1 7502 N 6 7502 N	1 7501 N 6 7501 N	1 7546 N 6 7546 N	1 7547 N 6 7547 N	1 7719 N
							We will supply this max height sign showing your selected height in both metres and feet
1 7545 N	1 7557 N	1 7555 N	1 7551 N	1 7554 N	1 7553 N	1 7559 N	
1 7507 N 6 7507 N	1 7556 N 6 7556 N	1 7544 N 6 7544 N	1 7550 N 6 7550 N	1 7549 N 6 7549 N	1 7505 N 6 7505 N	1 7511 N 6 7511 N	1 7506 N 6 7506 N
1 7508 KQ 6 7508 KQ	1 7509 KQ 6 7509 KQ	1 7514 Q 6 7514 Q	1 7515 Q 6 7515 Q	1 7512 Q 6 7512 Q	1 7513 Q 6 7513 Q		
1 7524 Q 7 7524 Q	1 7543 Q	1 7523 Q	1 7516 Q	1 6419 Q	1 7522 Q		
1 7528 Q 6 7528 Q	1 7510 KQ 6 7510 KQ	1 5432 KQ	1 7591 Q	1 7499 KQ	1 7500 KQ		
1 7612 Q	1 6417 MQ	1 6434 Q	1 6450 Q	1 6451 Q	1 4338 Q		
1 7529 Q	1 6475 Q	1 6476 Q	1 6477 Q	1 6462 Q	1 6440 P		
1 7594 K	1 7595 K	1 7596 K	1 7597 K	1 7592 KQ 7 7592 Q	1 7796 KQ		

Non-Reflective Site Traffic Signs

 1 7666 	 1 6426 	 1 6427 	 1 7624 	 1 7520 	 1 7584 
 1 7527  6 7527 	 1 7525  6 7525  7 7525 	 1 6437  6 6437 	 1 6452  6 6452 	 1 7526  6 7526 	 1 6431  6 6431  7 6431 
 1 6438  6 6438  7 6438 	 1 6470  6 6470 	 1 7519  6 7519 	 1 7518  6 7518 	 1 7668  6 7668 	 1 7571  6 7571  7 7571 
 1 7570  	 1 7541 	 1 7610 	 1 6430 	 1 6432 	 1 7590 
 1 6471  6 6471 	 1 7569  6 7569 	 1 7608  6 7608 	 1 7521  6 7521 	 1 7617  6 7617 	 1 7517  6 7517 
 1 7667  6 7667 	 1 7749  6 7749 	 1 7607  6 7607 	 1 7561  6 7561 	 1 7563  6 7563 	 1 7609  6 7609 
 1 7562 	 1 7564 	 1 6472 	 1 6453 	 1 7615 	 1 7618 
 1 7623 	 1 7622 	 1 7542  	 1 1743  	 1 7611 	 1 3221  7 3221 

Reversible Arrow Signs

These Rigid PVC or Aluminium signs are supplied with a detachable arrow and plastic wing nut that allows the arrow to be rotated to indicate the desired direction. Simply screw the wing nut tightly to secure in position.

Sign: 600 x 450mm
Arrow: 400 x 120mm



Rigid Plastic 5 7686
Aluminium 5 7688



Rigid Plastic 5 7687
Aluminium 5 7689



1 6412 
7 6412 
8 6412 



1 7531 

Material Codes

1 Rigid Plastic 6 Aluminium 8 Quick Fix
5 Miscellaneous 7 PET

Landscape Sizes

 400 x 300mm  400 x 400mm  600 x 450mm
 600 x 200mm  600 x 400mm

Portrait Sizes

 450 x 600mm

Material Information

For more information on our most popular materials, sizes and the locations they are most suited for see page 4-5.

Site Safety

It is important to understand the messages on construction site safety signs; they are displayed to deliver a clear health and safety message. Failing to abide by a sign could result in the loss of your job, or even your life. Signs come in many forms, from site hoarding and entrance points, to way guidance and will often consolidate several key safety messages onto one site safety board to avoid excessive sign clutter. Site signs deliver important information to warn of hazards or requirements that must be followed.



1 6412 **KQ**
7 6412 **Q**
8 6412 **K**



1 6439 **KQ**



1 6445 **Q**



1 6419 **Q**



1 6404 **MP** Banner with Eyelets
2 6404 **MP** 1270 x 610mm
7 6404 **MP** 5 5087
8 6404 **MP** Fluted Polypropylene
600 x 400mm
Includes Company Logo
5 5785



1 6464 **Q**



1 6218 **GM**
2 6218 **GM**



1 6217 **GM**
2 6217 **G**



1 6429 **M**
2 6429 **M**



1 6216 **GM**
2 6216 **GM**
8 6216 **GM**



1 6457 **GM**



1 6215 **GMP**



1 6223 **GM**
2 6223 **G**



1 6222 **M**
2 6222 **M**

Mandatory Signs



1 5018 **GMEK** Floor Graphic
2 5018 **GME** 400 x 600mm
5 8730



1 5003 **GMEK**
2 5003 **GMEK**
8 5003 **GE**



1 5232 **GM**
2 5232 **GM**
8 5232 **G**



1 5010 **GMEK**
2 5010 **GMEK**
8 5010 **GK**



1 5216 **MEKP** Floor Graphic
2 5216 **MEK** 400 x 600mm
6 5216 **M** 5 8820
7 5216 **M**
8 5216 **GE**



1 6229 **P**
6 6229 **P**



1 6236 **P** PVC Banner with Eyelets
8 6236 **P** 1270 x 610mm
5 5089



1 5019 **EKP**
2 5019 **EK**
6 5019 **P**



1 6402 **MP** PVC Banner
1270 x 1270mm
5 5115



1 6411 **KQ**



1 5210 **EK**
2 5210 **EK**



1 5235 **K**
2 5235 **K**
8 5235 **K**



1 5486 **MP**



1 6401 **MP**
7 6401 **M**



1 5221 **GM**
2 5221 **GM**



1 1632 **FGMN**
2 1632 **FGMN**



Contractor Pass System

Maintain a register of authorised contractors on site for use in case of emergency or for record tracking/invoice verification. Issue specific and clear ID for the contractor to display whilst on site (badge wallets sold separately). Ensure that Contractors have given commitment to site induction processes, and rules and regulations whilst on site. Record the authorised Work Location and Type of Work to be undertaken. Prompt for additional Permit to Work for where activity is high hazard or potentially hazardous. Includes notifications of Health and Safety instructions and Fire Register, whilst a data protection sheet keeps visitors' data confidential.

Includes 108 passes
Folded Pass: 103mm x 84.5mm - Book: 412mm x 280mm
5 7130

Badge wallets with clips
Pack of 10
5 6073

Branded & Bespoke Signage

To add company branding, use a different material or to create a truly unique sign message please refer to page 148.

Warning Signs

 <p>Danger Men at work</p> <p>1 4201 GM P 2 4201 GM</p> <p>Rigid Plastic A4 (210 x 297mm) 5 8376</p> <p>Self Adhesive A4 (210 x 297mm) 5 8377</p>	 <p>Danger People at work</p> <p>1 4334 GM P 2 4334 GM</p> <p>Rigid Plastic A4 (210 x 297mm) 5 4328</p> <p>Self Adhesive A4 (210 x 297mm) 5 4329</p>	 <p>Warning Construction site</p> <p>Rigid Plastic A4 (210 x 297mm) 5 8360</p> <p>Self Adhesive A4 (210 x 297mm) 5 8361</p>	 <p>Danger Vehicles unloading</p> <p>1 4244 K P</p>	 <p>Danger Scaffolding incomplete</p> <p>1 6442 P</p>	
 <p>Danger Men working below</p> <p>1 4203 GM P</p>	 <p>Danger People working below</p> <p>1 4336 GM P</p>	 <p>Warning Battery charging in progress</p> <p>1 4211 GM EK 2 4211 GM EK</p> <p>Projecting Sign Face: 150 x 200mm 5 4301</p>	 <p>Warning Fragile roof</p> <p>1 4261 GM EK P 2 4261 GM EK P 8 4261 GE</p>		
 <p>Danger Men working overhead</p> <p>1 4202 GM P 2 4202 GM</p>	 <p>Danger People working overhead</p> <p>1 4335 GM P 2 4335 GM</p>	 <p>Danger Falling objects</p> <p>1 6456 GM</p> <p>PVC Banner 1270 x 610mm 5 6456</p>	 <p>Danger Demolition work in progress</p> <p>1 6403 M P 2 6403 M</p> <p>PVC Banner 1270 x 610mm 5 5088</p>		
 <p>Danger Men working on plant</p> <p>1 4245 GM</p>	 <p>Danger People working on plant</p> <p>1 4337 GM</p>	 <p>Warning Hazardous area</p> <p>1 4240 GM 2 4240 GM 8 4240 G</p>	 <p>Warning Welding in progress</p> <p>1 4497 GM 2 4497 GM 8 4497 G</p>	 <p>Danger Asbestos hazard</p> <p>1 4409 GM P 2 4409 GM</p>	 <p>Danger Risk of falling</p> <p>1 4494 GM 2 4494 GM 8 4494 G</p>
 <p>Caution High noise level</p> <p>1 5220 GM 2 5220 GM</p>	 <p>Caution Arc welding</p> <p>1 4212 GM EK 2 4212 G</p>	 <p>Warning Danger of crushing</p> <p>1 3666 GM 2 3666 GM</p>	 <p>Danger Deep excavations</p> <p>1 4204 GM Q P 2 4204 GM</p>		
 <p>Danger Open pit</p> <p>1 6503 GM 2 6503 GM</p>	 <p>Danger Test area</p> <p>1 4230 G 2 4230 G</p>	 <p>Warning Look out for overhead loads</p> <p>1 6418 GM P 2 6418 G</p>	 <p>Warning Overhead crane</p> <p>1 6455 GM 2 6455 G</p>		
 <p>Danger Open manhole</p> <p>1 6454 GM</p>	 <p>Danger Quarry workings</p> <p>1 4232 GM</p>	 <p>Warning Site traffic</p> <p>1 6460 GM</p>	 <p>Warning Stand clear of suspended loads</p> <p>1 4250 GM</p>		
 <p>Warning It is dangerous and illegal to operate machines without the proper guards in position</p> <p>2 4262 G</p>	 <p>Warning Beware of moving vehicles</p> <p>1 6459 GM 2 6459 GM</p>	 <p>Danger Tipping exclusion zone</p> <p>1 4518 GM 2 4518 GM</p>	 <p>Warning Pedestrians</p> <p>1 5932 G K 2 5932 G K</p>		

Prohibition Signs

 <p>No unauthorised persons allowed beyond this point</p> <p>1 3202 GM EK P 2 3202 GM EK P 8 3202 GE K</p> <p>Floor Graphic 400 x 600mm 5 8740</p>	 <p>No exit</p> <p>1 3215 GE K 2 3215 GE K</p> <p>PVC Banner 1270 x 610mm 5 3215</p>	 <p>Access forbidden to all unauthorised persons</p> <p>1 3212 E K 2 3212 E K 8 3212 E K</p>	 <p>Scaffolding incomplete Do not use</p> <p>1 6443 P</p>	 <p>Do not alter or adapt any scaffold on site without prior official approval</p> <p>1 3645 K P</p>	 <p>No Smoking</p>  <p>No alcohol</p>  <p>No drugs</p>  <p>Failure to comply will result in disciplinary procedures</p> <p>1 3668 E K 2 3668 E K</p>
 <p>Children must not play on this site</p> <p>1 6405 M P 2 6405 P</p>	 <p>No vehicles beyond this point</p> <p>1 3217 GM P</p>				

Material Codes

1 Rigid Plastic 5 Miscellaneous 7 PET
2 Self Adhesive Vinyl 6 Aluminium 8 Quick Fix

Landscape Sizes

E 200 x 150mm G 300 x 100mm M 600 x 200mm P 600 x 400mm
F 200 x 200mm K 400 x 300mm N 400 x 400mm Q 600 x 450mm

Portrait Sizes

E 150 x 200mm P 400 x 600mm
K 300 x 400mm

Bespoke Site Safety Board

Creating your own site safety board has never been easier. Follow the three simple steps below and we can create a bespoke board showing your messages of choice with (or without) your company branding to ensure everyone understands your site specific rules and obligations. Manufactured on 5mm foam PVC these large format boards are perfect for positioning at site entrances to reinforce key safety messages and raising brand awareness in the process. If the templates below don't suit your needs then we are happy to quote for alternative sizes and materials.

Step One: Choose your Board

Select the board size needed and whether you require it to include your company logo / branding and contact details.

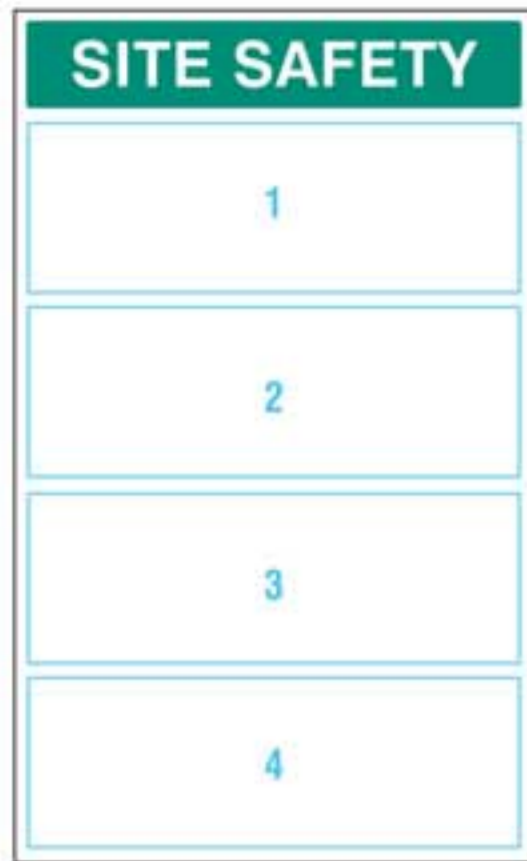

Space for four of the signs below

Without Logo
5mm Foam PVC
600 x 900mm
5 8039

Branded
5mm Foam PVC
600 x 1200mm
5 8030



Space for eight of the signs below

Without Logo
5mm Foam PVC
1200 x 900mm
5 8048

Branded
5mm Foam PVC
1200 x 1200mm
5 8047

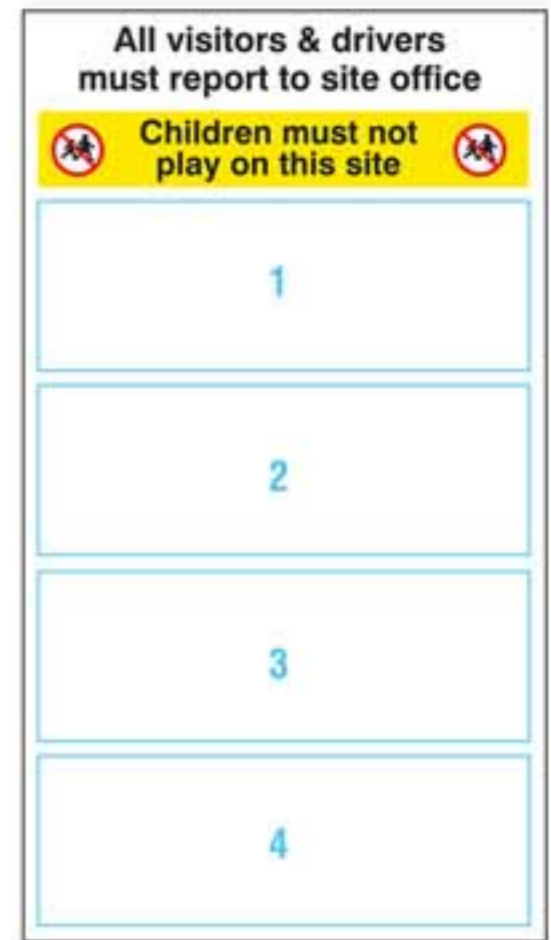

Space for four of the signs below

Without Logo
5mm Foam PVC
600 x 1000mm
5 8034

Branded
5mm Foam PVC
600 x 1200mm
5 8019

Step Two: Choose the Messages

Select the messages you wish to display on your board. You can select from the following (our most popular site safety signs) however if you require a different sign you can include alternative sign messages found throughout this catalogue by choosing option P and quoting the appropriate sign code.

A Hard hat must be worn	B Protective footwear must be worn	C High visibility jackets must be worn	D Ear protectors must be worn
E Speed and parking restrictions must be observed	F Warning Construction site Keep out	G Danger Stop. Look. Listen. Beware of trucks	H Warning Look out for overhead loads
I Danger Demolition work in progress	J No admittance for unauthorised personnel	K Site safety starts here	L Warning Construction work in progress Parents are advised to warn children of the dangers of entering this site
M Warning Danger of underground services	N Warning Heavy plant and machinery operate on this site	O First aid available from site office	P Any message of your choice

Step Three: Supply Logos, Artwork and/or Visuals

If you have selected a branded site safety board, please supply a high resolution copy of your logo, contact details and/or project information. EPS, PDF or Ai logo files are ideal however a clean, non pixelated high resolution jpeg should suffice (around 1500 x 1500 pixels).



This shows an example of the branded board design 5 8047 and includes a choice of 8 messages



For our range of standard pre-printed site safety boards see pages 120 - 122.

Site Safety Boards

Choose from our standard range of site safety boards. You can add company logo, project and contact details using the "Branded" codes.

Material Information

Foam PVC is a lightweight, rigid and durable material, easily drilled or screwed through, perfect for both indoor and outdoor use making it ideal for site boards. Has the added benefit of being difficult to ignite and is self-extinguishing.

4mm fluted twin wall polypropylene sheets offer a budget option for short term site boards. 100% recyclable, lightweight and waterproof, easily drilled for fixing to fencing, and hoardings.



SITE SAFETY

- No admittance for unauthorised personnel
- This is a hard hat area
- Protective footwear must be worn
- High visibility jackets must be worn

Without Logo
5mm Foam PVC
600 x 900mm
5 8035

Branded
5mm Foam PVC
600 x 1200mm
5 8022

SITE SAFETY

- Construction work in progress. Parents are advised to warn children of the dangers of entering this site
- Danger Demolition work in progress
- No admittance for unauthorised personnel
- Use ear protectors
- This is a hard hat area
- High visibility jackets must be worn
- Protective footwear must be worn
- Danger Look out for overhead loads

Without Logo
5mm Foam PVC
1200 x 900mm
5 8037

Branded
5mm Foam PVC
1200 x 1200mm
5 8027

SITE SAFETY

- High visibility jackets must be worn
- Protective footwear must be worn
- This is a hard hat area
- Danger Stop. Look. Listen. Beware of trucks

Without Logo
5mm Foam PVC
600 x 1000mm
5 8036

Branded
5mm Foam PVC
600 x 1200mm
5 8023

THINK SAFETY

- No unauthorised entry
- All visitors and delivery drivers must report to the site office
- Safety helmets, safety footwear and high visibility clothing must be worn at all times on this site
- You must be safety inducted to start work on this site
- Wear eye, ear, hand and respiratory protection where appropriate
- Danger of underground services. Check before you dig

Without Logo
5mm Foam PVC
900 x 1000mm
5 8031

Branded
5mm Foam PVC
900 x 1200mm
5 8025

Fluted Polypropylene
1220 x 1220mm
5 5800

SITE SAFETY

- All visitors & drivers must report to site office
- Children must not play on this site
- Construction work in progress. Parents are advised to warn children of the dangers of entering this site
- High visibility jackets must be worn
- Report all accidents immediately
- Danger Deep excavations
- Protective footwear must be worn
- Danger Stop. Look. Listen. Beware of trucks
- Safety helmets are provided for your safety and must be worn
- No access for unauthorised personnel

Without Logo
3mm Foam PVC
1200 x 1000mm
5 8097

5mm Foam PVC
1200 x 1000mm
5 8038

Branded
3mm Foam PVC
1200 x 1200mm
5 8098

5mm Foam PVC
1200 x 1200mm
5 8028

Fluted Polypropylene
1220 x 1220mm
5 5798

Lost Time Accident Boards

These displays are the perfect solution to communicate a construction sites excellent track record for safety.

SITE SAFETY

Days since the last lost time accident on this site

Without Logo
5mm Foam PVC
900 x 600mm
5 8033

Branded
5mm Foam PVC
900 x 700mm
5 8032

ZERO IN ON SAFETY

This plant has had Consecutive accident free days

Hear it See it Report it

The previous record was

YOUR LOGO HERE

Please help us to keep you safe. Report any near miss incidents.

Branded
5mm Foam PVC
700 x 900mm
5 8053



Our lost time accident boards come with two sets of Rigid PVC numbers, which slide into holders allowing quick and easy daily updates.

Bespoke Lost Time Boards

Alternative designs and messages can be created. Need a custom made Lost Time Board? ask for a quote.

Site Safety Boards

SITE SAFETY

Under the Health and Safety at Work Act 1974 all persons entering this site must comply with all regulations under this act. All visitors must report to the site office and obtain permission to proceed onto the site or any work area. Safety signs and procedures must be observed and personal protection and safety equipment must be used at all times.

 Construction work in progress. Parents are advised to warn children of the dangers of entering this site.

 Safety helmets must be worn

 Protective footwear must be worn

 High visibility jackets must be worn

 Unauthorised entry to this site is strictly forbidden

1 6447  | Fluted Polypropylene
7 6447  | 1220 x 1220mm
5 5794

SITE SAFETY

Under the Health and Safety at Work Act 1974 all persons entering this site must comply with all regulations under this act. All visitors must report to the site office and obtain permission to proceed onto the site or any work area. Safety signs and procedures must be observed and personal protection and safety equipment must be used at all times.

 Construction work in progress. Parents are advised to warn children of the dangers of entering this site.

 Safety helmets must be worn

 Protective footwear must be worn

 Unauthorised entry to this site is strictly forbidden

1 6413  |
7 6413  |

SITE SAFETY



Under the Health and Safety at Work Act 1974 all persons entering this site must comply with all regulations under this act. All visitors must report to the site office and obtain permission to proceed onto the site or any work area. Safety signs and procedures must be observed and personal protection and safety equipment must be used at all times.

 Construction work in progress. Parents are advised to warn children of the dangers of entering this site.

 Safety helmets must be worn

 High visibility jackets must be worn

 Unauthorised entry to this site is strictly forbidden

1 6420  | Fluted Polypropylene
7 6420  | 1220 x 1220mm
5 5796

SITE SAFETY



Under the Health and Safety at Work Act 1974 all persons entering this site must comply with all regulations under this act. All visitors must report to the site office and obtain permission to proceed onto the site or any work area. Safety signs and procedures must be observed and personal protection and safety equipment must be used at all times.

 Warning Dangerous site

 All visitors must report to the site office

 Approved personal protective equipment must be worn

 No unauthorised access

1 6416  | Fluted Polypropylene
7 6416  | 1220 x 1220mm
5 5793

SITE SAFETY

All visitors and contractors must report to site office to receive a site induction

 High visibility jackets must be worn

 Protective footwear must be worn

 No unauthorised access

 Any person caught pilfering or causing damage on this site will be liable for prosecution

 5 Maximum site speed

1 6597  |
7 6597  |

SITE SAFETY

Under the Health and Safety at Work Act 1974 all persons entering this site must comply with all regulations under this act. All visitors must report to the site office and obtain permission to proceed onto the site or any work area. Safety signs and procedures must be observed and personal protection and safety equipment must be used at all times.

 Safety helmets must be worn at all times



 Safety footwear must be worn at all times

 High visibility clothing must be worn at all times

 Vehicles must not enter the site without the authority of the site supervisor

 Unsupervised reversing in and out of site is strictly forbidden

 10 Maximum site speed

1 6596  |
7 6596  |

SITE SAFETY

Under the Health and Safety at Work Act 1974 all persons entering this site must comply with all regulations under this act. All visitors must report to the site office and obtain permission to proceed onto the site or any work area. Safety signs and procedures must be observed and personal protection and safety equipment must be used at all times.

 Construction work in progress. Parents are advised to warn children of the dangers of entering this site.

 Safety helmets must be worn

 Unauthorised entry to this site is strictly forbidden

1 6414  | Fluted Polypropylene
7 6414  | 900 x 600mm
5 6388

SITE SAFETY

 Heavy plant and machinery operate on this site

 Vehicles must not enter the site without the authority of the site supervisor

 Unsupervised reversing in and out of site is strictly forbidden

 Speed and parking restrictions must be observed

1 6415  | Fluted Polypropylene
7 6415  | 900 x 600mm
5 6389

Construction Site Sign Packs

- Comprised of the most commonly used construction signs
- Easy and economical way of purchasing construction site signs
- Each pack is supplied in an easy to store outer wrap
- All signs made from Rigid Plastic except where stated



Sign Pack 1 (9 Signs)

600 x 200mm, 600 x 450mm, 600 x 450mm, 600 x 450mm, 600 x 450mm, 600 x 450mm

5 6390

Sign Pack 2 (7 Signs)

900 x 600mm, 400 x 300mm, 300 x 100mm, 300 x 100mm, 300 x 100mm

5 6391

Sign Pack 3 (7 Signs)

900 x 600mm, 400 x 300mm, 300 x 100mm, 300 x 100mm, 300 x 100mm

5 6392

Sign Pack 4 (5 Signs)

900 x 600mm, 900 x 600mm, 400 x 600mm, 400 x 300mm, 600 x 400mm

5 6393

Sign Pack 5 (7 Signs)

600 x 450mm, 600 x 450mm, 400 x 400mm, 900 x 600mm

5 6678

Branded Sign Pack (12 Signs)

This pack is manufactured from Fluted Polypropylene and we can supply all these signs with your logo and details for no additional cost.

1220 x 610mm, 1220 x 1220mm, 400 x 400mm, 400 x 400mm, 400 x 400mm, 400 x 400mm, 400 x 400mm, 400 x 400mm, 400 x 400mm, 400 x 400mm, 600 x 400mm, 600 x 400mm

Fluted Polypropylene 5 5820

Material Codes
 1 Rigid Plastic
 5 Miscellaneous

Landscape Sizes
 7 PET
 600 x 450mm
 900 x 600mm

Material Information
 When ordering a sign, thought should be given to where that sign is going to be displayed. For more information on our most popular materials and the locations they are most suited for see page 4-5.

Information Boards & Courtesy Signs

SITE SAFETY

The following approved PPE must be worn on this site at all times

- Hard hat
- Goggles
- High visibility clothing
- Protective gloves
- Safety boots

All visitors and delivery drivers must report to the site office

YOUR LOGO HERE

5mm Foam PVC
600 x 900mm
5 8051

SITE SAFETY

The following approved PPE must be worn on this site at all times

- Hard hat
- Goggles
- Mask
- High visibility clothing
- Protective gloves
- Safety boots

All visitors and delivery drivers must report to the site office

YOUR LOGO HERE

5mm Foam PVC
600 x 900mm
5 8052

SITE SAFETY

The following approved PPE must be worn on this site at all times

- Hard hat
- High visibility clothing
- Protective gloves
- Safety boots

All visitors and delivery drivers must report to the site office

YOUR LOGO HERE

5mm Foam PVC
600 x 900mm
5 8050

SITE SAFETY RULES

Follow the four c's of site safety!

- competence**
Ensure you are fully trained for the task in hand and follow the relevant site safety procedures. If in doubt, ask your line manager.
- control**
Take responsibility for the safety of yourself and your colleagues. Lead by example and be aware of the consequences of your actions.
- co-operation**
Attend site induction and safety meetings to discuss safety issues & work together with management to create a safe working environment.
- communication**
If you see a near miss or unsafe situation report your concerns immediately. Challenge your workmates to do the right thing.

If you have doubts - ask your supervisor

5mm Foam PVC
600 x 900mm
5 6600

SITE SAFETY RULES

Whilst on this site I agree that I will:

- Do everything I can to ensure I go home safe
- Respect my colleagues and managers
- Communicate positively with those around me
- Challenge workmates to do the right thing
- Present myself fit for duty & ready to do the best I can
- Never take short cuts at the expense of safety
- Lead by example and be proud of my work
- Speak up if I see a near miss or something of concern
- Help my workmates if I see they need help
- Never forget rule number one

5mm Foam PVC
600 x 900mm
5 6599

SITE SAFETY

Are you wearing the correct colour of hard hat?

- Orange**
Slinger or Signaller
- Black**
Supervisors
- White**
Site Manager or Competent Operatives
- Blue**
All other staff and site visitors

All helmets must meet British Standards BS EN 307

5mm Foam PVC
600 x 900mm
5 6679

Courtesy Sign

Create a notification of street works with this bespoke courtesy sign. Supplied complete with four bungee ties (300mm) for easy fixing to barriers. Specify details when ordering: include text, layout and logo - as required.

YOUR LOGO Permit number []

YOUR TEXT HERE CONTACT DETAILS

This work is due for completion on: []

We apologise for any inconvenience caused during these essential works

Fluted Polypropylene
810 x 610mm
5 5138

Reflective Fluted Polypropylene
810 x 610mm
5 5139

Induction Poster & Pocket Guide

SITE SAFETY STARTS HERE

Before you start work today, answer the questions below and take the appropriate actions

STOP Talk to your supervisor or manager immediately. **YOU'RE GOOD TO GO!** Run a checklist on the sign and report any concerns to your team.

This guide should be used on a daily basis before your shift starts. To assess the safety of tasks being undertaken, it should also be used after every method statement briefing.

Did you understand your role on site?
Do you know who your supervisor/manager is?
Have you been briefed on the method statement and risk assessment?
Do you feel competent to carry out your job safely and correctly?
Have you got the correct plant and equipment to do your job?
Are you in good condition and fit for purpose?
Do you know where the emergency services are and the location of the first aid kit?
Are you wearing your PPE correctly?
Are you wearing correct PPE (hard hat, safety boots, high visibility clothing, gloves, ear and eye protection)?
Are you ready to perform any maintenance or general?
Do you know where the spill kit is and how to use it?
Do you have to lift anything you consider to be too heavy or difficult to move?
Do you know the location of all the public and their vehicles?
Do you have any other safety concerns about your job or site?

Working towards a safer workplace

Did you understand your role on site?
Do you know who your supervisor/manager is?
Have you been briefed on the method statement and risk assessment?
Do you feel competent to carry out your job safely and correctly?
Have you got the correct plant and equipment to do your job?
Are you in good condition and fit for purpose?
Do you know where the emergency services are and the location of the first aid kit?
Are you wearing your PPE correctly?
Are you wearing correct PPE (hard hat, safety boots, high visibility clothing, gloves, ear and eye protection)?
Are you ready to perform any maintenance or general?
Do you know where the spill kit is and how to use it?
Do you have to lift anything you consider to be too heavy or difficult to move?
Do you know the location of all the public and their vehicles?
Do you have any other safety concerns about your job or site?

Working towards a safer workplace

WE TAKE YOUR SAFETY SERIOUSLY

YOU SHOULD TOO!

This poster should be used on a daily basis before your shift starts. To assess the safety of tasks being undertaken, it should also be used after every method statement briefing.

Working towards a safer workplace

5mm Foam PVC
600 x 900mm
5 8054

Laminated Card
75 x 90mm
5 8055

Aluminium Roll Top Signs 400 x 600mm

Manufactured from aluminium, these durable roll top signs are designed to neatly hook over scaffolding and railings and display the appropriate message.



Bespoke Roll Top

We can create custom aluminium roll top signs with your message of choice. Please supply artwork or any relevant details when ordering.

600 x 400mm 5 6386 | 400 x 600mm 5 7127



Hooped Banners 440GSM PVC Fabric Banner

Stitched fabric hoops allow the insertion of a scaffold tube to secure the banner. Excellent advertising opportunities for scaffold companies or to portray safety messages.



The perfect option to include company advertising whilst scaffolding is in place. Please supply artwork or any relevant details when ordering.

Scaffolding Inspection Kits

All kits are supplied in a reusable box enabling books to be stored / filed securely.

Replacement components (tags, books and seals) can be purchased independently as and when required.

For the full range of equipment inspection systems see pages 131 - 135.



Weekly Kit
1 x Status Tag
2 x Check Books
100 x Tamper Evident Seals
1 x Wallet & Pen
5 1320



Daily Kit
2 x Status Tag
11 x Check Books
300 x Tamper Evident Seals
1 x Wallet & Pen
5 1321

Scaffolding Signs



1 6442 P



1 6443 P



1 3645 KP

Scaffolding Tags

These double sided scaffold tie tags are ideal for highlighting important safety information on fixed scaffolding. Supplied in packs of 10 and come with 150mm cable ties.



Matt PVC
80 x 150mm
5 3444



Matt PVC
80 x 150mm
5 3445

Worker ID Tags

Worker ID products provide paramedics and first-responders with critical medical information for faster and more appropriate treatment. It also provides important contact information to allow responders to notify loved ones of the situation immediately. With the ID tag's security seal, workers can be sure their personal information remains secure until required.

Made from durable, reflective, water-resistant and non-conductive materials and can stand up to tough conditions. Helmet safe adhesive backing and the synthetic paper ID tag inside is 100% waterproof, so vital information stays dry and safe.



Standard Worker ID Tag
70mm x 15mm
5 3446



Worker ID Tag with Data Window
85 x 20mm
5 3447

Site Amenity Signs



1 6408 **GM**
2 6408 **GM**
7 6408 **G**
8 6408 **G**



1 7061 **G**
2 7061 **G**
7 7061 **GM**
8 7061 **G**



1 7053 **GL**
2 7053 **G**
7 7053 **GL**



1 7051 **GL**
2 7051 **G**
7 7051 **GL**



1 7017 **GL**
2 7017 **GL**



1 6436 **GM**
2 6436 **GM**



1 6410 **GM**
2 6410 **GM**



1 6409 **GM**
2 6409 **GM**



1 7046 **GL**
2 7046 **GL**



1 6446 **GM**
2 6446 **GM**



1 6424 **GM**
2 6424 **GM**



1 7018 **GL**
2 7018 **GL**

General Notices

Your Logo Here

We take our responsibilities seriously

This project aims to minimise its impact on the environment through reducing, reusing and recycling and sourcing materials from sustainable sources wherever possible

1 6683 **KQ**
2 6683 **K**

Your Logo Here

We take our responsibilities seriously

This project aims to work to the highest standards within the industry. We are committed to providing a well presented site perimeter, offices, welfare facilities and storage area. We aim to manage and minimise any disruptions

1 6684 **KQ**
2 6684 **K**

Your Logo Here

We take our responsibilities seriously

This project aims to provide a safe and positive environment. We are committed to behave in a professional and courteous manner and have an active part in developing the construction industries future

1 6685 **KQ**
2 6685 **K**

Your Logo Here

We take our responsibilities seriously

Nothing you do on this site today will be as important as going home to your family and loved ones tonight

1 6686 **KQ**
2 6686 **K**

Spot a Hazard
Assess the Risk
Find the Cause
Evaluate Solutions
Terminate the Danger
You are Safe

1 1749 **KQ**

**No hat
No boots
No job**

1 6435 **K**

**No hat
No boots
No vest
No job**

1 6444 **KQ**

Notice
Trespassers
will be
prosecuted

1 7006 **K**

**No tools
stored in
this vehicle
overnight**

2 1723 **E**

**All visitors
must report
to reception**

1 7055 **E**
2 7055 **E**

**All visitors
please
sign in**

1 7092 **E**
2 7092 **E**

Notice
Authorised
persons only

1 7044 **EK**
2 7044 **EK**

Custom Made Signs

We can create custom signs to include company branding or site specific information. Advise us of your requirements for a quote or refer to page 148 for more information.

Near Miss Station

Take a proactive approach to improving site safety and ensure that all near misses and incidents are recorded and acted upon with this near miss station. Includes a suggestion box to store near miss slips (Slips sold separately).

10mm Foam PVC
600 x 440mm
5 6687

Near Miss Slips

Allow near miss incidents to be recorded and show the actions taken to eliminate repeat occurrences.

Pack of 10
Matt PVC
80 x 150mm
5 6688

Front Reverse

Suggestion Box

Fabricated in yellow polystyrene with a clear acrylic A5 sign holder on the front (insert your message of choice). The pocket behind the holder can be used to store your near miss tags. Sliding door at the rear gives access to remove the contents. The box is freestanding but can also be wall mounted.

Yellow Polystyrene with a Clear Acrylic front
W 275 x H 275 x D 100mm with 145mm Wide Slot
5 6689

Near Miss Record Book Station

A near miss record book is an ideal way to keep track of incidents that almost result in injury, allowing you to improve your health and safety measures in the future. Ensure your employees make good use of the record book by wall-mounting it with this station (pre-drilled for easy mounting). (Books ordered separately - see page 45).

3mm Thick Plastic
360 x 220 x 15mm
5 5938

Notice Boards

A range of notice boards manufactured from 5mm foam PVC. Helps to ensure everyone is aware of site rules and procedures at all times. They include clear document wallets to place relevant documentation inside. A Health & Safety Law Poster is also included on each board. If documents are removed from the wallet a "Missing" message will be displayed.



Branded Notice Boards

We can add company details and branding to our range of Notice Boards or if you're looking for something completely bespoke we can provide you with custom Notice Board designs to suit your needs. Contact us now for a quote.

Notice Board 1

Permits to Work Notice Board



REGISTER & CONTACT DETAILS	COMPANY H&S POLICY	SITE RULES	INSURANCE CERTIFICATE
Missing	Missing	Missing	Missing
HOT WORKS PERMIT	ELECTRICAL WORKS PERMIT	CONFINED SPACES PERMIT	WORKING AT HEIGHT PERMIT
Missing	Missing	Missing	Missing
HAZARDOUS SUBSTANCES PERMIT	EXCAVATION PERMIT	ASBESTOS PERMIT	OTHER PERMITS
Missing	Missing	Missing	Missing

Document Wallets for:

- Register & Contact Details
- Site Rules
- Electrical Works Permit
- Company H&S Policy
- Excavation Permit
- Confined Spaces Permit
- Hot Works Permit
- Asbestos Permit
- Working at Height Permit
- Other Permits
- Hazardous Substances Permit

5mm Foam PVC
1430 x 1075mm
5 8178

Notice Board 2

Site safety starts here



OPEN DOOR POLICY	COMPANY H&S POLICY	INSURANCE CERTIFICATE	F10 NOTIFICATION FORM
Missing	Missing	Missing	Missing
SITE RULES	EMPLOYMENT CONTACT LIST	FIRST AID POLICY	ANY OTHER INFO
Missing	Missing	Missing	Missing
FIRE PLAN	FIRE ACTION	FIRE POINT LOCATION SITE PLAN	
Missing	Includes a printed Fire Action Notice	Missing	

Document Wallets for:

- Open Door Policy
- Site Rules
- Fire Point Location Site Plan
- Company H&S Policy
- Fire Plan
- Emergency Contact List
- Insurance Certificate
- First Aid Policy
- Any Other Information
- F10 Notification Form

5mm Foam PVC
1430 x 1075mm
5 8021

Notice Board 3

Health and Safety Notice Board



REGISTER & CONTACT DETAILS	COMPANY H&S POLICY	H&S MINUTES	ACCIDENT STATISTICS
Missing	Missing	Missing	Missing
FIRE POINT LOCATION SITE PLAN	FIRE PLAN	FIRE ACTION	
Missing	Missing	Includes a printed Fire Action Notice	
SITE RULES	FIRE LOG BOOK	ACCIDENT REPORT BOOK	EMPLOYEE H&S BOOK
Missing	Missing	Missing	Missing

Document Wallets for:

- Register & Contact Details
- Fire Point Location Plan
- Fire Plan
- Company H&S Policy
- Accident Report Book
- Site Rules
- H&S Minutes
- Employee Hand Book
- Fire Log Book
- Accident Statistics

5mm Foam PVC
1430 x 1075mm
5 8177

Notice Board 4

Site Project Notice Board



REGISTER & CONTACT DETAILS	SITE INSPECTION REGISTER	CONSTRUCTION PHASE PLANS	F10 NOTIFICATION FORM
Missing	Missing	Missing	Missing
PROJECT PLAN	FIRE PLAN	FIRST AID PLAN	SITE RULES
Missing	Missing	Missing	Missing
CONTRACTOR RISK ASSESSMENT	CONTRACTOR RISK ASSESSMENT	CONTRACTOR RISK ASSESSMENT	CONTRACTOR RISK ASSESSMENT
Missing	Missing	Missing	Missing

Document Wallets for:

- Register & Contact Details
- Fire Plan
- F10 Notification Form
- Site Inspection Register
- First Aid Plan
- Project Plan
- Construction Phase Plans
- Site Rules
- 4 x Risk Assessment / Method Statement

5mm Foam PVC
1430 x 1075mm
5 8179

Document Holder Signs

Keep important safety documents clearly displayed and readily available in a central location by using Safety Document Holders.

Our document holders come with a durable clear polystyrene document holder perfect for storing A4 ring binders and other A4 folders.

See page 45 for more information.



Document Holder

Keep important documents clearly displayed and readily available in a central location.

Durable clear polystyrene document holder, pre-drilled for easy wall mounting using the screw fixing kit supplied.

Perfect for storing A4 ring binders.

380x180x105mm (W x H x D)
5 9899



Material Codes

1 Rigid Plastic 2 Self Adhesive Vinyl 5 Miscellaneous 7 PET 8 Quick Fix

Landscape Sizes

E 200 x 150mm G 300 x 100mm K 400 x 300mm L 450 x 150mm M 600 x 200mm Q 600 x 450mm

Site Saver Safety Signs

This range of signs are manufactured using a 4mm thick fluted polypropylene material. This low-cost material allows us to provide you with your own branded signs at an affordable price (perfect for temporary site signage - strong, lightweight and waterproof). Send your high resolution logo at time of ordering for inclusion on site saver signs at no extra cost. If you can't see the sign you require please contact us as we can produce any design on a variety of materials.



Site Saver Safety Signs 4mm Fluted Polypropylene - 600 x 400mm

<p>5 5745</p>	<p>5 5752</p>	<p>5 5748</p>	<p>5 5747</p>	<p>5 5751</p>
<p>5 5755</p>	<p>5 5754</p>	<p>5 5753</p>	<p>5 5757</p>	<p>5 5758</p>
<p>5 5762</p>	<p>5 5763</p>	<p>5 5759</p>	<p>5 5760</p>	<p>5 5761</p>
<p>5 5765</p>	<p>5 5767</p>	<p>5 5768</p>	<p>5 5784</p>	<p>5 5787</p>
<p>5 5769</p>	<p>5 5770</p>	<p>5 5771</p>	<p>5 5772</p>	<p>5 5778</p>
<p>5 5785</p>	<p>5 5783</p>	<p>5 5775</p>	<p>5 5776</p>	<p>5 5777</p>
<p>5 5786</p>	<p>5 5781</p>	<p>5 5789</p>	<p>5 5790</p>	<p>5 5791</p>

Bespoke Site Saver Sign

Create your own message or company advert with this flexible option – just supply the artwork or details of what is required when ordering. If you require a different sized sign please call for a quote.

1220 x 810mm
5 5805



Free Branding

Our site saver signs include the option to add a logo. Supply it when ordering. Signs can also be supplied unbranded.



Cable Ties

A range of nylon cable ties for easy attachment to posts or fencing.

Size	10 Pack	50 Pack
150mm	5 8695	5 8696
370mm	5 8698	
770mm	5 8697	

Sign Clip

Easy fixing to posts and fencing without drilling or damaging your polypropylene sign.



Step 1 Position the clip on the front of the sign



Step 2 Place thumbs at the end of the clip and press firmly until the nubs pop through to the rear



Step 3 Position the back plate over the nubs at the rear and click into place



Step 4 Insert cable tie for easy attachment to post or fencing

40 x 10mm
5 8687

Site Saver Safety Signs

To help encourage an environmentally friendly approach to signage we now include the appropriate recycling logo on the sign to help identify when one of our signs can be recycled and to help recycling centres correctly identify and process the materials efficiently without the need to send them into landfill. Don't worry if you can't see the sign you require, you can order any sign in any of our eco-friendly materials. See page 148 for more information.



Site Saver Amenity Signs 4mm Fluted Polypropylene - 400 x 400mm

 5 5712	 5 5718	 5 5724	 5 5733	 5 5730	 5 5731	 5 5732
 5 5700	 5 5703	 5 5740	 5 5739	 5 5706	 5 5707	 5 5708
 5 5741	 5 5727	 5 5728	 5 5729	 5 5709	 5 5710	 5 5711
<p>Your Logo Remember to send us your high resolution logo when ordering Site Saver Signs.</p>	 5 5742	 5 5743	 5 5744	 5 5736	 5 5737	 5 5738

Site Saver Safety Boards 4mm Fluted Polypropylene - 1220 x 1220mm

 5 5793	 5 5796	 5 5794
 5 5802	 5 5798	 5 5801

Multi-Message Banners

440gsm PVC - Banners include eyelets



Our banners are manufactured from a lightweight, durable and weather resistant material. PVC banners can be rolled up for easy transportation and storage. Perfect for site safety and advertising messages. Banners include eyelets for easy fixing to fencing with cable or bungee ties.

SITE SAFETY

Under the Health and Safety at Work Act 1974 all persons entering this site must comply with all regulations under this act. All visitors must report to the site office and obtain permission to proceed onto the site or any work area. Safety signs and procedures must be observed and personal protection and safety equipment must be used at all times.

Warning Dangerous site

All visitors must report to the site office

Approved personal protective equipment must be worn

No unauthorised access

YOUR LOGO/DETAILS HERE

Branded
1270 x 810mm
5 5137

SITE SAFETY

Under the Health and Safety at Work Act 1974 all persons entering this site must comply with all regulations under this act. All visitors must report to the site office and obtain permission to proceed onto the site or any work area. Safety signs and procedures must be observed and personal protection and safety equipment must be used at all times.

Construction work in progress. Parents are advised to warn children of the dangers of entering this site.

Safety helmets must be worn

Protective footwear must be worn

High visibility jackets must be worn

Unauthorised entry to this site is strictly forbidden

YOUR LOGO/DETAILS HERE

Branded
1270 x 810mm
5 5118

SITE SAFETY

All visitors & drivers must report to site office

Children must not play on this site

Construction work in progress. Parents are advised to warn children of the dangers of entering this site.

High visibility jackets must be worn

Report all accidents immediately

Danger Deep excavations

Protective footwear must be worn

Danger Stop. Look. Listen. Beware of trucks

Safety helmets are provided for your safety and must be worn

No access for unauthorised personnel

YOUR LOGO/DETAILS HERE

Branded 1270 x 810mm 5 5127
Without Logo 2440 x 1270mm 5 5085

SITE SAFETY

Under the Health and Safety at Work Act 1974 all persons entering this site must comply with all regulations under this act. All visitors must report to the site office and obtain permission to proceed onto the site or any work area. Safety signs and procedures must be observed and personal protection and safety equipment must be used at all times.

Construction work in progress. Parents are advised to warn children of the dangers of entering this site.

Safety helmets must be worn

High visibility jackets must be worn

Unauthorised entry to this site is strictly forbidden

YOUR LOGO/DETAILS HERE

Branded
1270 x 810mm
5 5124

SITE SAFETY

Construction work in progress. Parents are advised to warn children of the dangers of entering this site.

Danger Demolition work in progress

No admittance for unauthorised personnel

Use ear protectors

This is a hard hat area

High visibility jackets must be worn

Protective footwear must be worn

Danger Look out for overhead loads

YOUR LOGO/DETAILS HERE

Branded 1270 x 810mm 5 5128
Without Logo 2440 x 1270mm 5 5086

SITE SAFETY

Heavy plant and machinery operate on this site

Vehicles must not enter the site without the authority of the site supervisor

Unsupervised reversing in and out of site is strictly forbidden

Speed and parking restrictions must be observed

YOUR LOGO/DETAILS HERE

Branded 1270 x 810mm 5 5125
Without Logo 2440 x 1270mm 5 5084

SITE SAFETY

Under the Health and Safety at Work Act 1974 all persons entering this site must comply with all regulations under this act. All visitors must report to the site office and obtain permission to proceed onto the site or any work area. Safety signs and procedures must be observed and personal protection and safety equipment must be used at all times.

Construction work in progress. Parents are advised to warn children of the dangers of entering this site.

Safety helmets must be worn

Protective footwear must be worn

Unauthorised entry to this site is strictly forbidden

YOUR LOGO/DETAILS HERE

Branded
1270 x 810mm
5 5119

SITE SAFETY

All visitors and delivery drivers must report to site office

No Hard Hat, No Boots, No Hi-Vis, No Job!

Danger Construction site

High visibility clothing must be worn

Safety helmets must be worn

No unauthorised persons beyond this point

Protective footwear must be worn

5 Site speed limit

YOUR LOGO/DETAILS HERE

Branded 1270 x 810mm 5 5144
Without Logo 2440 x 1270mm 5 5145

Site Safety Banners 440gsm PVC - 1270 x 610mm - Banners include eyelets

 5 5088	 5 6456	 5 5087
 5 3215	 5 2011	 5 2012
 5 5093	 5 5094	 5 5095
 5 5089	 5 3221	 5 5090
 5 5092	 5 5091	 5 6470

We can also manufacture our banners on perforated mesh pvc material for use in exposed outdoor locations where wind may be an issue. This material has tiny holes allowing air to pass through and reduces the wind-loading on structures. Please call for a quote.

 Cable Ties Nylon cable ties for easy attachment. <table border="1"><tr><th>Size</th><th>10 Pack</th><th>50 Pack</th></tr><tr><td>150mm</td><td>5 8695</td><td>5 8696</td></tr><tr><td>370mm</td><td>5 8698</td><td></td></tr><tr><td>770mm</td><td>5 8697</td><td></td></tr></table>	Size	10 Pack	50 Pack	150mm	5 8695	5 8696	370mm	5 8698		770mm	5 8697		 Bungee Ties A pack of four shock cord bungee ties for easy attachment. Pack of 4 300mm Lengths 5 5141	Bespoke Banners We can create custom banners using supplied images, logos etc. When ordering these banners please supply your design and other details in a high resolution format. Contact us quoting the following codes: <table border="1"><tr><th>Size</th><th>Code</th></tr><tr><td>1270 x 610mm</td><td>5 5096</td></tr><tr><td>1270 x 1220mm</td><td>5 5097</td></tr><tr><td>2440 x 1270mm</td><td>5 5098</td></tr></table>	Size	Code	1270 x 610mm	5 5096	1270 x 1220mm	5 5097	2440 x 1270mm	5 5098	 Your message here
Size	10 Pack	50 Pack																					
150mm	5 8695	5 8696																					
370mm	5 8698																						
770mm	5 8697																						
Size	Code																						
1270 x 610mm	5 5096																						
1270 x 1220mm	5 5097																						
2440 x 1270mm	5 5098																						

 This image shows an example of the bespoke banner - code 5 5129 (to the right) and includes company logo, project and contact details. This example shows 8 messages (however a maximum of 10 messages can be added).	 SITE SAFETY Space for up to 10 safety messages Your company logo/details here
	Branded 2440 x 1270mm 5 5129 Maximum of 10 messages - Please confirm requirements when ordering

Construction Site Signs

Barrier Tape

Heavy duty, non adhesive polyethylene barrier tape creates an instant, high visibility cordon. Each roll is supplied in a handy dispenser carton.



Non-Adhesive Polythene
70mm x 500m
5 8620



Non-Adhesive Polythene
70mm x 500m
5 8621



Non-Adhesive Polythene
75mm x 200m
5 8611

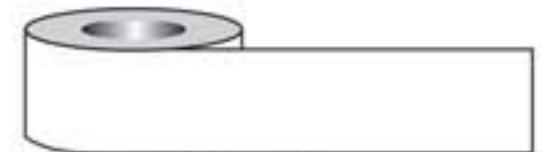

Non-Adhesive Polythene
75mm x 200m
5 8614



Non-Adhesive Polythene
75mm x 200m
5 8612



Non-Adhesive Polythene
75mm x 200m
5 8610



Non-Adhesive Polythene
75mm x 200m
5 8609



Non-Adhesive Polythene
75mm x 200m
5 8613



Non-Adhesive Polythene
75mm x 250m
5 8608



Non-Adhesive Polythene
75mm x 250m
5 8634

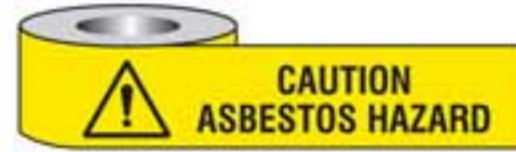

Non-Adhesive Polythene
75mm x 250m
5 8607



Non-Adhesive Polythene
75mm x 250m
5 8622

Reflective Barrier Tape

Complete with retro-reflective warning stripes for added night time visibility.

Non-adhesive Reflective Polythene
75mm x 250m
5 8649



Barrier Tape Dispenser

Hand held dispenser with a serrated cutting edge. Allows quick deployment of barrier tape.

5 8652

Underground Warning Tape

Mark the position of buried pipes and cables with underground tape.

High visibility 100% virgin grade plastic with resistance to fading and high resistance to acids, alkalis and oils.



150mm x 365m
5 8636



150mm x 365m
5 8637



150mm x 365m
5 8638

Folding Barrier

One piece, lightweight, portable folding barrier system, conforming to UK traffic signs manual Chapter 8, supplied ready assembled with 3 or 4 sides. Single sided reflective red and white flexible panels.

3-Sided | 4-Sided
5 7988 | 5 7989



Extending Barrier

Space saving metal barrier. Stands 1 metre high and expands to 3 metres in length.

Concertina design allows the barrier to be quickly extended for immediate use. Made of steel, assembled with rivets with lacquered paint finish. Ø25 mm post, Ø 30 mm feet

Weight: Approx 8kg
3000 x 1000mm
5 7994



Cone Barrier

This handy Cone Barrier unit fits over the top of most standard traffic cones and connects them together using 3.65m of retractable, high visibility chevron webbing.

This is a highly effective, low cost solution to create a safety barrier. and can be used to cordon off areas where there is work in progress.

They are suitable for motorway maintenance, road-works and Health & Safety barriers.

Chevron Webbing
150mm x 3.65m
One unit required per cone
5 7983 *Cones not included



Barrier Tape Post

This red painted steel post is simply pushed into the ground for the quick and easy deployment of barrier tape.

The forged steel pointed tip enables easier insertion into earth.

Once the posts are in position simply wrap your barrier tape of choice around the post to secure an area quickly and efficiently – ideal for construction sites or event management.

12mm Diameter Steel
1200mm height
1.8kg weight
5 8619 *Tape not included



Additional barrier tape messages and designs are available upon request so if you cannot see the message you require please specify the wording, colours and width/length that you would like and we will advise of availability and price. Custom print jobs may incur extended lead-times.





A simple tagging and checklist system designed to improve safety, reduce maintenance costs and comply with legislation.

The ability to monitor and record equipment helps improve safety and maintenance programmes, whilst saving money and maximising efficiency by allowing faults to be identified early and arranging repairs before they develop into something more serious and costly.

This simple but highly effective Safe Equipment Management System allows pre-use inspections to be completed on workplace equipment and the findings clearly displayed for

all to see, removing any doubt as to when the last check was completed. This enables inspectors to spot potential faults, before they develop into a more costly or serious defect.

A perfect addition to any safety or maintenance management programme and meets requirements of PUWER (Provision & Use of Work Equipment Regulations), LOLER (Lifting Operations and Lifting Equipment Regulations) and WAHR (Working at Height Regulations).

We now also offer a paperless option in the form of the "TakeAIM" app.

Complete workplace inspections directly on a smart phone / tablet by accessing comprehensive checklists

for each asset. Each checklist allows users to add photos and notes to back-up their inspection findings.

This system allows companies to inspect any type of equipment digitally.

An online dashboard manages the data and gives management easy and instant access to all data. TakeAIM enables data to be analysed to help spot trends and any recurring issues, helping with planning maintenance and ensuring replacement parts are available when required.

To find out more please quote product code "TAKEAIM" to arrange a call-back.

Checks for all workplace equipment

Good to Go Safety have supplied companies worldwide with millions of equipment inspections and we now offer a paperless option in the form of the "TakeAIM" app.



Annual Kits

Regular equipment inspections can help identify potential faults before they develop into costly and dangerous defects.

The frequency of inspections can be defined by a wide range of variants. On occasion, legislation will set out the specific time period that checks must be made or alternatively a risk assessment may define how often an inspection should be carried out (based upon the level of risk and the potential outcome if a fault goes undetected).

Using the Good to Go Safety system will help you improve safety, reduce maintenance costs and enable you to comply with the relevant legislation. Kits are supplied in a reusable box enabling books to be stored / filed securely. Replacement components can be purchased independently as and when required.



Daily Inspection Kit

The daily inspection kit provides you with everything required to carry out 275 inspections (ideal for one year of daily inspections). *based on a five day working week

Within the kit you will receive:

2 x Status Tag - Attach to the equipment and show its status.

11 x Check Books - (275 checklists) allowing one to be completed each week and the findings displayed inside the status tag.

300 x Tamper Evident Seals - Deter and identify unauthorised access to the status tag

1 x Wallet - Store the current book and provide a suitable writing surface when completing checklists

1 x Pen - Store inside the wallet to ensure there is always a way to record findings



Forklift: 5 1313	Pallet Truck: 5 1338	MEWP: 5 1324	Excavator: 5 1344	Telehandler: 5 1372	Overhead Crane: 5 1353	Tow Tractor: 5 1359
Ladder: 5 1315	Scaffold Tower: 5 1314	Harness: 5 1327	Podium Steps: 5 1332	Tractor: 5 1347	Forklift Platform: 5 1350	Straddle Carrier: 5 1394
Racking: 5 1316	Fixed Scaffolding: 5 1321	Bespoke: 5 1334	Fleet Vehicle: 5 1329	Trailer: 5 1341	Loader Crane: 5 1356	

Weekly Inspection Kit

The weekly inspection kit provides you with everything you require to carry out fifty inspections (ideal for one year of weekly inspections).

Within the kit you will receive:

1 x Status Tag - Attach to the equipment and show its status.

2 x Check Books - (50 checklists) allowing one to be completed each week and the findings displayed inside the status tag.

100 x Tamper Evident Seals - Deter and identify unauthorised access to the status tag

1 x Wallet - Store the current book and provide a suitable writing surface when completing checklists

1 x Pen - Store inside the wallet to ensure there is always a way to record findings



Forklift: 5 1309	Pallet Truck: 5 1337	MEWP: 5 1323	Excavator: 5 1343	Telehandler: 5 1371	Overhead Crane: 5 1352	Tow Tractor: 5 1358
Ladder: 5 1311	Scaffold Tower: 5 1310	Harness: 5 1326	Podium Steps: 5 1331	Tractor: 5 1346	Forklift Platform: 5 1349	Straddle Carrier: 5 1393
Racking: 5 1312	Fixed Scaffolding: 5 1320	Bespoke: 5 1333	Fleet Vehicle: 5 1328	Trailer: 5 1340	Loader Crane: 5 1355	

How it Works

One of the many reasons why people like to use Good to Go Safety is its simplicity and ease to integrate into a company's safety and maintenance programme. Simply attach a tag to the relevant equipment and select the appropriate check book to start carrying out the inspection at a frequency of your choice. Inserting the completed checklist into the tag on the equipment provides a clear visual breakdown of what was checked and when – removing any assumptions or uncertainties. A duplicate copy is retained in the book for management records and providing invaluable evidence in the event of an accident.

Tag it

Attach a universal status tag to the piece of equipment. Ideally at the point of entry.



Check it

Use the appropriate check book to complete a comprehensive inspection.



Record it

Complete the inspection checklist and record all findings. Sign and date.



Insert it

Remove the top sheet of the checklist, fold where prompted and insert into the status tag.



Secure it

Fit a tamper evident seal to provide additional security and ensure findings are legitimate.



Display it

The universal status tag will now display the date and the findings of the inspection.



Components & Accessories

Good to Go Safety has three main components, the Universal Status Tag, Inspection Check Books and Tamper Evident Seals, these components make up our simple and effective preventative maintenance system. The Good to Go System can help detect damaged or faulty equipment early and can help to prevent accidents and/or reduce maintenance costs whilst ensuring that legislative requirements are met (PUWER, LOLER, WAHR) and more.

Universal Status Tag

Attach to workplace equipment (usually at the point of entry) and advise employees when the equipment is safe to use or quarantined following an inspection. Unlike other tagging systems this tag has been designed to attach to all types of equipment. The channelled base allows a flush fitting onto scaffold tubes and the small sleek design ensures that it doesn't interfere with daily equipment use.

Due to being manufactured from tough, durable, UV stable, weather resistant polypropylene it can withstand harsh condition - whether attached to fixed scaffolding during a thunderstorm or attached to a ladder being tossed around in the back of a van, this status tag can resist it all.

The highly visible yellow design ensures staff are reminded to complete pre-use checks. When the tag is empty the window displays a "Do Not Use" message - this means an inspection has not been completed and the equipment should not be used. Once an inspection has been completed the status tag holds the top sheet of the checklist and the window will display the date and the equipment's status.

The design includes two sleeves to enable cable tie attachment. Four holes for riveting or screwing onto equipment and the design is lightweight enough to ensure that adhesive can be used as a fixing option.

Polypropylene
120 x 52 x 13mm (H x W x D)
5 1301



Inspection Check Books

Each of the Good to Go Safety Check Books have been specifically designed to provide comprehensive inspections for workplace equipment in order to help meet the relevant legislation, industry guidelines and best practice.

Each check book includes 25 inspections. Once an inspection has been completed, the top sheet (white) is removed from the book, folded at the prompted lines and placed inside the tag to display the current status of the equipment...either "Do Not Use" or "Good to Go". The secondary sheet (yellow) is a carbon copy which should be retained within the book.

Carbon copies can provide invaluable evidence of your Safe Equipment Management System (SEMS) history in the event of an accident.

Every check list requires a name, details of the asset in question and lists a series of questions regarding the asset. Each checklist has a unique sequential number to aid audits and management documentation.

Useful guidance can be found within the inside sleeve of the Check Book to help highlight what inspectors should be looking for during the inspection.

Custom options are available. Please let us know if you have a specific requirement for equipment we don't currently offer.



Forklift: 5 1302	Pallet Truck: 5 1336	MEWP: 5 1322	Excavator: 5 1342	Telehandler: 5 1370	Overhead Crane: 5 1351	Tow Tractor: 5 1357
Ladder: 5 1304	Scaffold Tower: 5 1303	Harness: 5 1325	Podium Steps: 5 1330	Tractor: 5 1345	Forklift Platform: 5 1348	Straddle Carrier: 5 1392
Racking: 5 1305	Fixed Scaffolding: 5 1319	Bespoke: 5 1317	Fleet Vehicle: 5 1306	Trailer: 5 1339	Loader Crane: 5 1354	

Wallet & Pen

A useful accessory to protect the Good to Go Safety Check Book from general wear and tear whilst in use.

The wallet is PVC coated to help protect the checklist from contaminants such as water, dust or oil. The wallet also provides inspectors with a solid writing surface whilst they are on the move.

The Check Book (not included) slips into a secure sleeve on one side of the wallet and on the other side there are useful guidance notes regarding the Good to Go Safety system.

The ball point pen is stored inside a tight sleeve within the wallet ensuring it is always available during inspections.

PVC Coated
250 x 235 x 3mm (Flat)
250 x 115 x 8mm (Folded)
5 1308



Tamper Evident Seals

Provide a visual indicator that an inspection has been completed and verified by a competent inspector. Using the Seals ensures the findings within the Status Tag are not tampered with and the correct status is always shown.

If a Tamper Evident Seal is missing, employees should not use the equipment until the checklist has been confirmed and a new Seal is inserted by a competent inspector.

Manufactured from blue acetal thermoplastic to offer maximum visibility against the yellow status tag.

The design enables the arrow head to fit snug into the status tag and the neck has been hollowed in order to help the seal to snap easier when pulled forward.

A simple solution to provide additional security measures to equipment safety.

Polypropylene
Supplied in boxes of 100
5 1307



Dispensers

Setting up a warehouse, factory or site in an efficient and organised manner is beneficial for a number of reasons. Not only does it assist in inventory control and time management, but it also streamlines the entire process of completing inspections, from re-ordering and auditing to selecting and storing.

Information Station

This wall mounted information station provides details of the Good to Go Safety equipment inspection process whilst offering easy access to check books from an organised central location.

Ideal for warehouses, factories or within site offices where equipment inspections can be misplaced or damaged.

The information station comes with five acrylic check book dispensers. Each dispenser holds up to ten check books (not included) ensuring that even busy warehouses have enough space for fifty check books.

The dispensers not only keep your check books organised, but they also provide visual awareness when replacement books are required to be ordered. Supplied with a high bond adhesive backing for easy application to the board but can also be screwed into place.

The board is manufactured from 10mm Foam PVC which ensures the information station is strong and sturdy whilst also enabling easy drilling for wall mounting.

Adding your company logo is included in the cost of the information station. Remember to supply us with a high resolution file when placing your order.

10mm Foam PVC
700 x 750mm
5 1335



Bespoke Information Station

If you require to show a different equipment type or wish to have a completely bespoke information station please contact us for a quote.

Good to Go Safety

Promoting best practice.

YOUR LOGO HERE

- 1** **Tag it**
Attach a tag to the equipment
- 2** **Check it**
Use the relevant check book to carry out a pre-use equipment inspection
- 3** **Record it**
The completed checkbook should be returned to the central location and the status tag inserted into the book for management records
- 4** **Display it**
Take out the tag when prompted and insert the tag into the status tag
- 5** **Secure it**
Insert a tamper resistant seal to ensure the information is secure and tamper resistant
- 6** **You're Good to Go...**
The tag will now advise when equipment is "Good to Go" or if a check is found. The "Do not use" message is removed and all remaining operations be completed.

a

The empty tag displays a "Do not use" message until a checklist is inserted.

b

Completed checklists should be dated and display the current status.

c

A seal can secure the findings. If the seal is missing, a new checklist should be completed.

Document Holding Signs 10mm Foam Board - 440 x 600mm

Keep important safety documents clearly displayed and in a readily available place. These displays help companies organise their important documents and help staff remain informed and up to date regarding all workplace information. Signs are supplied with a clear polystyrene document holder.

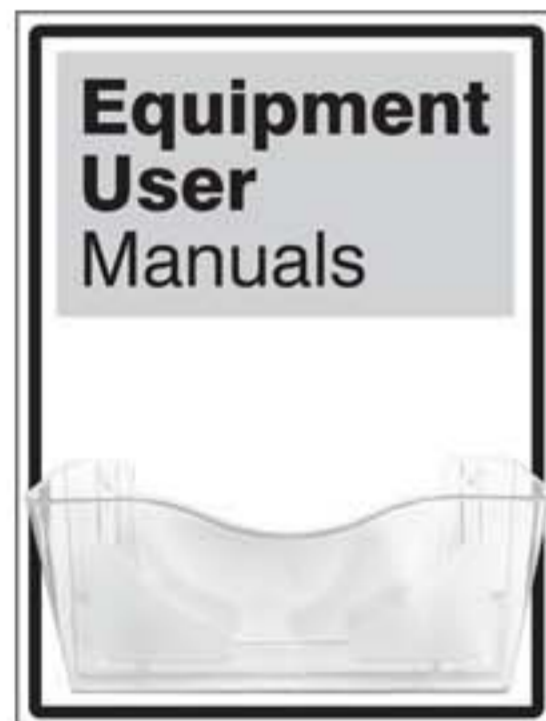

5 8217



5 8218



5 1385

Document Holder

A durable clear polystyrene document holder which is pre-drilled for easy wall mounting using the supplied fixing kit.



Polystyrene
380 x 180 x 105mm (W x H x D)
5 9899

Acrylic Dispenser

This acrylic check book dispenser holds up to ten check books (not included) ensuring that equipment inspections are easy accessible from a central location whilst ensuring they are not misplaced or irrevocably damaged.

The dispensers not only keep your check books organised, but they also provide visual awareness when replacement books are required to be ordered.

The acrylic dispenser is self standing but is also pre-drilled for simple wall mounting.



External Dimensions: 165 x 117 x 76mm (H x W x D)
Internal Dimensions: 160 x 109 x 65mm (H x W x D)
5 8099

Weather Resistant Folder

These industrial strength pockets are perfect for storing check books and manuals on outdoor equipment.

The press seal fastening keeps those important inspection checklists clean and dry and always on location.

The folder comes with a high bond adhesive backing strip for semi permanent fixings to your equipment.

Clear PVC
Holds A4 documents
5 8109



Inspection Posters 420 x 594mm - These posters are printed on an eco-friendly, PVC-free synthetic paper that supplies excellent tear and water resistance properties.

Reinforce the importance of completing pre-use inspections on workplace equipment with these workplace safety posters. This range of posters have been designed in order to provide strong visual reminders to employees and highlight components included in the Good to Go Safety inspection check books. A perfect addition to your safe equipment management systems.



GET TO KNOW YOUR LADDERS
CARRY OUT PRE-USE CHECKS

- 1 Inspect
- 2 Clean
- 3 Check
- 4 Test
- 5 Check
- 6 Test
- 7 Check
- 8 Test
- 9 Check

Need more inspection checklists? www.goodtogosafety.co.uk

5 1361

GET TO KNOW YOUR MEWP
CARRY OUT PRE-USE CHECKS

- 1 Inspect
- 2 Clean
- 3 Check
- 4 Test
- 5 Check
- 6 Test
- 7 Check
- 8 Test
- 9 Check
- 10 Test
- 11 Check
- 12 Test
- 13 Check
- 14 Test
- 15 Check
- 16 Test
- 17 Check
- 18 Test

Need more inspection checklists? www.goodtogosafety.co.uk

5 1366

GET TO KNOW YOUR PALLET TRUCKS
CARRY OUT PRE-USE CHECKS

- 1 Inspect
- 2 Clean
- 3 Check
- 4 Test
- 5 Check
- 6 Test
- 7 Check
- 8 Test
- 9 Check
- 10 Test
- 11 Check
- 12 Test
- 13 Check
- 14 Test
- 15 Check
- 16 Test
- 17 Check
- 18 Test

Need more inspection checklists? www.goodtogosafety.co.uk

5 1364

GET TO KNOW YOUR FORKLIFTS
CARRY OUT PRE-USE CHECKS

- 1 Inspect
- 2 Clean
- 3 Check
- 4 Test
- 5 Check
- 6 Test
- 7 Check
- 8 Test
- 9 Check
- 10 Test
- 11 Check
- 12 Test
- 13 Check
- 14 Test
- 15 Check
- 16 Test
- 17 Check
- 18 Test

Need more inspection checklists? www.goodtogosafety.co.uk

5 1360

GET TO KNOW YOUR TRACTOR
CARRY OUT PRE-USE CHECKS

- 1 Inspect
- 2 Clean
- 3 Check
- 4 Test
- 5 Check
- 6 Test
- 7 Check
- 8 Test
- 9 Check
- 10 Test
- 11 Check
- 12 Test
- 13 Check
- 14 Test
- 15 Check
- 16 Test
- 17 Check
- 18 Test

Need more inspection checklists? www.goodtogosafety.co.uk

5 1386

GET TO KNOW YOUR TRAILERS
CARRY OUT PRE-USE CHECKS

- 1 Inspect
- 2 Clean
- 3 Check
- 4 Test
- 5 Check
- 6 Test
- 7 Check
- 8 Test
- 9 Check
- 10 Test
- 11 Check
- 12 Test
- 13 Check
- 14 Test
- 15 Check
- 16 Test
- 17 Check
- 18 Test

Need more inspection checklists? www.goodtogosafety.co.uk

5 1365

GET TO KNOW YOUR LOADER CRANE
CARRY OUT PRE-USE CHECKS

- 1 Inspect
- 2 Clean
- 3 Check
- 4 Test
- 5 Check
- 6 Test
- 7 Check
- 8 Test
- 9 Check
- 10 Test
- 11 Check
- 12 Test
- 13 Check
- 14 Test
- 15 Check
- 16 Test
- 17 Check
- 18 Test

Need more inspection checklists? www.goodtogosafety.co.uk

5 1367

GET TO KNOW YOUR EXCAVATOR
CARRY OUT PRE-USE CHECKS

- 1 Inspect
- 2 Clean
- 3 Check
- 4 Test
- 5 Check
- 6 Test
- 7 Check
- 8 Test
- 9 Check
- 10 Test
- 11 Check
- 12 Test
- 13 Check
- 14 Test
- 15 Check
- 16 Test
- 17 Check
- 18 Test

Need more inspection checklists? www.goodtogosafety.co.uk

5 1369

GET TO KNOW YOUR VEHICLES
CARRY OUT PRE-USE CHECKS

- 1 Inspect
- 2 Clean
- 3 Check
- 4 Test
- 5 Check
- 6 Test
- 7 Check
- 8 Test
- 9 Check
- 10 Test
- 11 Check
- 12 Test
- 13 Check
- 14 Test
- 15 Check
- 16 Test
- 17 Check
- 18 Test

Need more inspection checklists? www.goodtogosafety.co.uk

5 1387

GET TO KNOW YOUR SCAFFOLDING
CARRY OUT PRE-USE CHECKS

- 1 Inspect
- 2 Clean
- 3 Check
- 4 Test
- 5 Check
- 6 Test
- 7 Check
- 8 Test
- 9 Check
- 10 Test
- 11 Check
- 12 Test
- 13 Check
- 14 Test
- 15 Check
- 16 Test
- 17 Check
- 18 Test

Need more inspection checklists? www.goodtogosafety.co.uk

5 1388

GET TO KNOW YOUR TOWER
CARRY OUT PRE-USE CHECKS

- 1 Inspect
- 2 Clean
- 3 Check
- 4 Test
- 5 Check
- 6 Test
- 7 Check
- 8 Test
- 9 Check
- 10 Test
- 11 Check
- 12 Test
- 13 Check
- 14 Test
- 15 Check
- 16 Test
- 17 Check
- 18 Test

Need more inspection checklists? www.goodtogosafety.co.uk

5 1363

GET TO KNOW YOUR HARNESS
CARRY OUT PRE-USE CHECKS

- 1 Inspect
- 2 Clean
- 3 Check
- 4 Test
- 5 Check
- 6 Test
- 7 Check
- 8 Test
- 9 Check
- 10 Test
- 11 Check
- 12 Test
- 13 Check
- 14 Test
- 15 Check
- 16 Test
- 17 Check
- 18 Test

Need more inspection checklists? www.goodtogosafety.co.uk

5 1368

GET TO KNOW YOUR PODIUM STEPS
CARRY OUT PRE-USE CHECKS

- 1 Inspect
- 2 Clean
- 3 Check
- 4 Test
- 5 Check
- 6 Test
- 7 Check
- 8 Test
- 9 Check
- 10 Test
- 11 Check
- 12 Test
- 13 Check
- 14 Test
- 15 Check
- 16 Test
- 17 Check
- 18 Test

Need more inspection checklists? www.goodtogosafety.co.uk

5 1389

GET TO KNOW YOUR FORKLIIFT'S WORK PLATFORM
CARRY OUT PRE-USE CHECKS

- 1 Inspect
- 2 Clean
- 3 Check
- 4 Test
- 5 Check
- 6 Test
- 7 Check
- 8 Test
- 9 Check
- 10 Test
- 11 Check
- 12 Test
- 13 Check
- 14 Test
- 15 Check
- 16 Test
- 17 Check
- 18 Test

Need more inspection checklists? www.goodtogosafety.co.uk

5 1390

GET TO KNOW YOUR OVERHEAD CRANE
CARRY OUT PRE-USE CHECKS

- 1 Inspect
- 2 Clean
- 3 Check
- 4 Test
- 5 Check
- 6 Test
- 7 Check
- 8 Test
- 9 Check
- 10 Test
- 11 Check
- 12 Test
- 13 Check
- 14 Test
- 15 Check
- 16 Test
- 17 Check
- 18 Test

Need more inspection checklists? www.goodtogosafety.co.uk

5 1391

GET TO KNOW YOUR RACKING
CARRY OUT PRE-USE CHECKS

- 1 Inspect
- 2 Clean
- 3 Check
- 4 Test
- 5 Check
- 6 Test
- 7 Check
- 8 Test
- 9 Check
- 10 Test
- 11 Check
- 12 Test
- 13 Check
- 14 Test
- 15 Check
- 16 Test
- 17 Check
- 18 Test

Need more inspection checklists? www.goodtogosafety.co.uk

5 1362

External Fitting

Whatever the sign, we can supply the necessary fixings to ensure it is clearly visible using sign frames, adhesives, posts and clips, screws and cable ties.



Grey Steel Posts

Grey painted steel pole available in a range of different lengths and diameters.

76mm Diameter		50mm Diameter	
3.6 metre	5 8684	3 metre	5 8769
3 metre	5 8678	2.5 metre	5 8676
2.5 metre	5 8675	1.5 metre	5 8800
1.75 metre	5 8688		



Post Caps

Grey plastic cap, which fits onto the end of a post for a professional looking finish and helps prevent water ingress.

Grey Plastic	Grey Plastic
50mm Dia	76mm Dia
5 8750	5 8685

Road Frames

Sign frames include a 300mm ground clearance to meet recommendations for UK road sign regulations.

Manufactured from Grey Zinc Painted Steel.

See page 113 for more options and additional information.



Triangle	Square	Rectangle
600 x 680mm	400mm	600 x 450mm
750 x 850mm	5 8551	1050 x 750mm
750 x 850mm with Supp Plate	5 8758	5 8553
5 8757	5 8761	5 8759



Anti-Rotational Clip

Simple installations are achieved by inserting the 'foot' into the sign channel, and twisting the clip through 90°. The bolt then secures the other end. Raised pips on the inner help prevent sign rotation.

Stainless Steel	Stainless Steel
50mm Diameter	76mm Diameter
5 8640	5 8682



Base Plate

Recommended for secure and level anchoring of sign posts. Install this base plate approximately 600mm below the surface and tighten post to create a stable post. Zinc coated steel base plate.

Steel	Steel
50mm Diameter	76mm Diameter
5 8699	5 8686



2 Piece Saddle

Saddle that slides into the sign channel. The saddle accepts all bands up to 19mm (3/4") and as the band tightens the saddle clamps tightly against the channel holding the sign securely in place.

70 x 30 x 30mm
5 8754



Back-to-Back Clips

Allows 2 signs to be fitted back to back to a steel post. Back to Back clips are fitted with M8 bolts. Two clips are required per channel whether one or two post mounting. Supplied in pairs.

Stainless Steel	Stainless Steel
50mm	76mm
5 8689	5 8725



Banding Tool, Buckle and Straps

Has a tensioning capability of 2,400lbs and a built-in cutter for use with banding straps up to 19mm wide. Firstly, push band through buckle teeth towards the operator, ears up. Pass band around object and again through buckle. (For best results repeat this operation to obtain double banding). Anchor end of band by folding back under buckle. Take up slack. Then place band in slots of tool and push nose of tool against the buckle. Grip band with clamping lever and apply tension by turning handle. Maximum pressure is being applied when there is no appreciable movement of band between nose and clamping block. Then you can swing tool over buckle. This movement increases tension of band and, to avoid breakage, handle must be reversed slightly as tool is swung over, whilst maintaining band tension. Cut band with cutter lever and slide tool off in same position (or tension will be lost). Finally, hammer ears down over cut band.

Banding Tool	Banding Strap	Banding Buckle
5 8751	19mm x 30m	Pack of 10
	5 8752	5 8753

Tamtorque Clamp and Driver

These tamtorque clamps are manufactured from stainless steel and have been designed for clamping signs to all types of posts. They give a quick and reliable fix to round, square or hexagonal posts every time. It removes the need to cut the band to size and therefore have no sharp edges, which can snag or cut. Unlike other banding systems, the tamtorque clamp can be easily reused or readjusted. Tamtorque clamps are manufactured from high strength stainless steel and have a hardened tamper resistant screw with a unique recessed seven-sided socket. This means that they can only be tightened or released with a special Tamtorque driver. An auto locking safety buckle ensures the free end of the band is safely tidied away.

Attach to sign channel with a 2-piece saddle (sold separately)

Tamtorque Clamps				2 Piece Saddle	Tamtorque Driver
70 -100mm	100-130mm	130-190mm	190-250mm	70 x 30 x 30mm	5 8770
5 8772	5 8774	5 8778	5 8780	5 8754	



Installation Guide



1. Thread the band through the two-piece saddle and around the post.



2. Screw the band through the housing using the driver or power tool.



3. Push any remaining band into the buckle for a safe, tidy finish.



4. Hold down any excess band while finally tightening.



5. Tamtorque can be released and re-positioned if required.

Internal Fitting

Whatever the sign, we can supply the necessary fixings to ensure it is clearly visible using sign frames, adhesives, posts and clips, screws and cable ties.



Adapt-a-Sign Frames

Adapt-a-Sign frames enable you to print off your own message and insert inside. A perfect solution for displaying constantly changing information.

Clear PVC with 10mm coloured border
215 x 310mm
Holds A4 sheet

Colour	Black	Red	Green	Blue	Yellow
Code	5 6197	5 6191	5 6192	5 6193	5 6194



Suspended Frames

This impact resistant polyvinyl plastic frame is an ideal solution to hanging signs. It can be used both single and double sided and is supplied complete with suspension kit for easy installation.

	White	Black	Grey	Red	Green	Blue	Yellow
300 x 100mm	5 8700	5 8716	5 8681	5 8706	5 8703	5 8720	5 8713
450 x 150mm	5 8701	-	5 8680	-	5 8704	-	-
600 x 200mm	5 8702	5 8717	5 8674	5 8707	5 8705	5 8721	5 8714



Ceiling Button

Self Adhesive White Plastic
20 x 20mm - Pack of 10
5 8106



Fixing Clip

Clear Plastic
20 x 20mm - Pack of 10
5 8104



Magnetic Hook

32mm Diameter
5 8087



Large Fixing Clip

White Plastic
20 x 30mm - Pack of 10
5 8727



Adhesive Pad

Self Adhesive Tabs
10 x 25mm - Pack of 4
5 8724



Hook & Loop Dots

Self Adhesive Tabs
20mm Diameter - Pack of 10
5 8728



Double Sided Tape

Acrylic High-Bond Tape
33mm x 25mm
5 8105



Sign Adhesive

Silicone
310ml
5 8694



Sign Adhesive Gun

Silicone Gun
5 8693



Suspension Kit

For easy attachment of lightweight signs to ceiling.

Two 150mm Wire Hooks
Two Self Adhesive Ceiling Buttons
5 8100



Chain Suspension Kits

Polished chain for a prestigious ceiling fixing.

2 x 500mm Brass Chain	2 x 500mm Chrome Chain
4 x Brass Hooks	4 x Chrome Hooks
2 x Ceiling Buttons	2 x Ceiling Buttons
5 8729	5 8679



Ceiling Hook Holder

Ideal for suspending signs up to 10kg

36mm Diameter x 60mm
2 x 150mm Wire Hooks
5 8110 - Supplied in Pairs - Screws not included



Poly Top Screws

Pack of 12

Black	Red	Green	Blue	Yellow	White
5 8781	5 8777	5 8773	5 8771	5 8779	5 8775



Cable Ties

	Pack of 10	Pack of 50
150mm	5 8695	5 8696
370mm	5 8698	-
770mm	5 8697	-



Sign Clips

Sign clip for site saver signs.
Easy fixing to posts or fencing.
5 8687



Bungee ties

300mm Length
Pack of 4
5 5141

Coronavirus Site Safety

A range of signs to help keep your site, employees and visitors safe in line with current COVID-19 government guidelines. It is important that site safety signs display a clear message so that employees and visitors understand the site requirements.

SITE SAFETY - COVID 19

Do not enter this site if you or anyone in your household have any symptoms of COVID 19

This site operates with a strict social distancing policy

Maintain strict hand cleaning and surface cleaning policies at all times

PPE is provided for your safety and must be worn

Failure to follow these guidelines may result in disciplinary procedures

1 8273 W Fluted Polypropylene
900 x 600mm
5 8273

SITE SAFETY - COVID 19

Do not enter this site if you or anyone in your household have any symptoms of COVID 19

Wash your hands regularly

Keep a safe distance of at least 2 metres

Cough or sneeze into the crease of your elbow or into a tissue

Avoid physical contact

Always wash your hands before touching your face

1 8461 W Fluted Polypropylene
900 x 600mm
5 8461

2m

SITE SAFETY - COVID 19

Do not enter this site if you or anyone in your household have any symptoms of COVID 19

No physical interactions of any kind are permitted on these premises

Wash and sanitise your hands regularly and thoroughly

Keep a safe distance of at least 2 metres

Cough or sneeze into the crease of your elbow or into a tissue

Failure to follow these guidelines may result in disciplinary procedures

1 8463 Q Fluted Polypropylene
450 x 600mm
5 8463

2m

SITE SAFETY - COVID 19

Do not enter this site if you or anyone in your household have any symptoms of COVID 19

Wash or sanitise hands frequently and thoroughly

Wear masks

Wear gloves

Keep a safe distance of at least 2 metres

1 8462 Q Fluted Polypropylene
450 x 600mm
5 8462

2m

SITE SAFETY - COVID 19

Do not enter this site if you or anyone in your household have any symptoms of COVID 19

The measures necessary to minimise the risk of spread of infection rely on everyone on this site to take responsibility for their actions and behaviours

The policies put in place to protect our staff from Coronavirus are not optional. They must be complied with at all times

Failure to follow these guidelines may result in disciplinary procedures

1 8459 W Fluted Polypropylene
900 x 600mm
5 8459

TEMPERATURE CHECK STATION

Sanitise your hands

Maintain a safe distance

Cover your face

1 1261 HK
2 1261 HK

Coronavirus precautions

Wash your hands regularly with soap and use hand sanitiser if available

Please maintain a safe 2 metre social distance

Do not touch surfaces and products unless absolutely necessary

1 8452 HK
2 8452 H

2m

Prevent the spread of Coronavirus

Catch it
Cover your nose and mouth with a clean tissue when you cough or sneeze

Bin it
Dispose of used tissue in your nearest bin

Kill it
Washing your hands and cleaning surfaces prevents the spread of germs

2 5028 E Self Adhesive Vinyl
150 x 200mm - Pack of 5
5 5028

SANITISATION STATION

Put on gloves

Use the gloves provided to protect yourself and others from spreading the Coronavirus.

Disinfect surfaces

Before using the station, disinfect surfaces which you intend to touch.

Wash your hands

Wash your hands for a minimum of 20 seconds with soap and warm water.

Dispose of tissues

Use the paper towels provided to dry your hands and turn off the tap.

PREVENT THE SPREAD OF CORONAVIRUS

1 8447 Q Fluted Polypropylene
600 x 450mm
5 8447

Projecting Sign

Identify a sanitisation station quickly and easily from several viewing angles by using this projecting sign

Rigid Plastic
Face: 150 x 200mm
CV0031

Eco-Friendly Material

Signage manufactured from fluted polypropylene is 100% recyclable, lightweight and weather resistant.

Free Standing Signs

These double sided, free standing signs are ideal to attract staff and customers' attention. Yellow warning signs are recognised throughout the UK to highlight potential danger, therefore are much more likely to be adhered to by customers and staff. These self standing signs help remind the public of their responsibilities in terms of social distancing, considered vital to ensuring the safety of others.

Your message here

SOCIAL DISTANCING

PLEASE KEEP CONTACT WITH OTHERS TO PREVENT THE SPREAD OF COVID-19

Please keep a safe distance of at least 2m from others

PLEASE KEEP YOUR DISTANCE

2m

5 8524

5 8569

5 8570

Coronavirus Information Signs

Research has revealed that 80% of people in the UK feel safer in venues with clear, professional COVID-19 signage. The study has revealed that people are more likely to shop in stores with clear instructions on social distancing measures. The findings also indicate that brands risk reputational damage from inadequate COVID-19 signage.

**COVID-19
WORKPLACE PRECAUTIONS**

As a responsible employer, I confirm this business is complying with the government's guidance on managing the risk of Coronavirus.

- ✓ We have carried out a COVID-19 risk assessment and shared the results with the people who work here
- ✓ We have cleaning, handwashing and hygiene procedures in line with guidance
- ✓ We have taken all reasonable steps to help people work from home
- ✓ We have taken all reasonable steps to maintain a safe social distance in the workplace
- ✓ Where a safe social distance is not feasible, we have done everything practical to manage transmission risk

Employer _____ Date _____

If you feel any of these statements are untrue, you should call your HR Manager or discuss directly with Health & Safety Executive at enquiries@hse.gov.uk or call them on 0300 555 1337

1 8577 **HK**
2 8577 **HK**

**OFFICE
ETIQUETTE**

- Stay home if you are unwell or have come in contact with anyone who is sick
- Wash your hands regularly
- Clean frequently used items and objects
- Catch coughs and sneezes with a clean tissue or in the crease of your elbow
- Maintain a safe distance at all times
- Please be conscious not to stand too close to colleagues' desks when in discussions

Thank you for your understanding and cooperation

1 8572 **HK**
2 8572 **HK**

**KITCHEN
ETIQUETTE**

- Wash your hands before using any of the kitchen equipment or utensils
- Please disinfect all surfaces after use
- Please wear a face mask or cover your face
- Maintain a safe distance at all times
- Use paper towels to dry your hands, utensils and / or dishes then dispose of them in the bin
- All plates and cutlery should be cleaned and returned to the drawers after use

Thank you for your understanding and cooperation

1 8573 **HK**
2 8573 **HK**

Attention all visitors

In response to the recent outbreak of the Coronavirus (COVID - 19) we ask all visitors to self-screen before entering the building, to help lessen the spread of the virus.

Do not enter if:

- You have signs of a fever or a high temperature (above 38°C)
- You have a persistent cough or respiratory problems
- You have had contact with any possible source of the virus

If you have met any of the above criteria please return home and contact NHS 111 for advice

If you are safe to enter please do so and follow the guidance below:

- Wash your hands regularly and thoroughly with soap and water or alcohol based hand sanitiser
- Avoid touching your face with your hands
- If you need to cough or sneeze, use a tissue and bin after use
- Where possible avoid contact with vulnerable individuals such as the elderly and those with underlying health conditions

1 5029 **HK**
2 5029 **HK**

**SOCIAL
DISTANCING**

Help stop the spread of COVID-19, stay apart!

Keep a safe distance

USE THE FLOOR MARKERS AS GUIDANCE FOR SOCIAL DISTANCING MEASURES

1 8262 **KP** Floor Graphic
400 x 600mm
5 8262

**Coronavirus
Help stop the Spread**

PROTECT YOURSELF AND OTHERS AROUND YOU BY FOLLOWING THESE SIMPLE STEPS:

- Wash your hands regularly with soap or hand sanitiser
- Catch coughs and sneezes with a clean tissue
- Wipe down surfaces in the vicinity of you
- Wipe down your hands before you touch your face
- Maintain a safe distance during work and breaks
- If you don't have a tissue use the crease of your elbow

USE THE FLOOR MARKERS AS GUIDANCE FOR SOCIAL DISTANCING MEASURES

1 8260 **KP**

**COVID-19
PRECAUTIONS**

As a responsible retailer with a duty of care to both our customers and staff we have introduced the following measures in light of the coronavirus pandemic:

ONLY CUSTOMERS
in the premises at any one time please

- Maintain a safe distance of at least 2 metres at all times
- Catch coughs and sneezes with a clean tissue

Thank you for your cooperation, patience and understanding

1 8423 **HK**
2 8423 **HK** **2m**

**COVID-19
PRECAUTIONS**

As a responsible retailer with a duty of care to both our customers and staff we have introduced the following measures in light of the covid19 pandemic:

ONLY CUSTOMERS
in the premises at any one time please

- Maintain a safe distance of at least 2 metres at all times
- Catch coughs and sneezes with a clean tissue

Thank you for your cooperation, patience and understanding

1 8424 **HK**
2 8424 **HK** **2m**

COVID-19 STOP THE SPREAD

HANDS
Wash your hands regularly with soap and water for at least 20 seconds. Use hand sanitiser between visits to reduce the risk of spreading the virus.

FACE
Cover your face to reduce the risk of spreading the virus via breath vapour.

SPACE
Transmission of the virus is most likely to happen within two metres. Keep a safe distance from others to maximise your and others safety.

Thank you for your understanding

1 1263 **HK**
2 1263 **HK**

Please pay by contactless or card whenever possible

We would appreciate if you could sanitise your hands before using the keypad

Thank you for understanding

1 8584 **HK**
2 8584 **HK**

**CARD AND
CONTACTLESS
PAYMENTS ONLY**

We are currently not accepting cash payments

Sorry for any inconvenience

1 8471 **HK**
2 8471 **HK**

**Access is by
appointment
only**

Sorry for any inconvenience

1 8937 **HK**
2 8937 **HK**

**Only one
person at a
time please**

Thank you for your cooperation

1 8494 **HK**
2 8494 **HK**

**Maximum of
2 people at
a time please**

Thank you for your cooperation

1 8495 **HK**
2 8495 **HK**

**Maximum of
3 people at
a time please**

Thank you for your cooperation

1 8498 **HK**
2 8498 **HK**

**No more than
4 people in
these premises
at any one
time please**

1 8427 **HK**
2 8427 **H**

Material Codes

1 Rigid Plastic 2 Self Adhesive Vinyl 5 Miscellaneous

Landscape Sizes

L 600 x 450mm **W** 900 x 600mm

Portrait Sizes

P 150 x 200mm **H** 250 x 300mm **K** 300 x 400mm **P** 600 x 400mm **Q** 600 x 450mm

Floor Graphics

Sub-surface printed and over laminated in durable anti-slip polycarbonate film. Ideal for high traffic areas to remind staff and visitors of safety procedures and safe social distances.



External Floor Graphics

We can supply floor graphics on a high quality external grade material for application to textured outdoor ground surfaces such as asphalt, concrete and pavements.

If you require external floor graphics please contact us for a quote.



Social Distancing Signs



Coronavirus Flyer



To view our full range of Coronavirus safety signage and products, please contact us and request a copy of our latest COVID-19 Flyer.

Our COVID-19 Flyer has hundreds of additional designs to choose from

Table Cards

Ideal for helping maintain a safe social environment in retail and hospitality sectors. Manufactured from Rigid PVC.

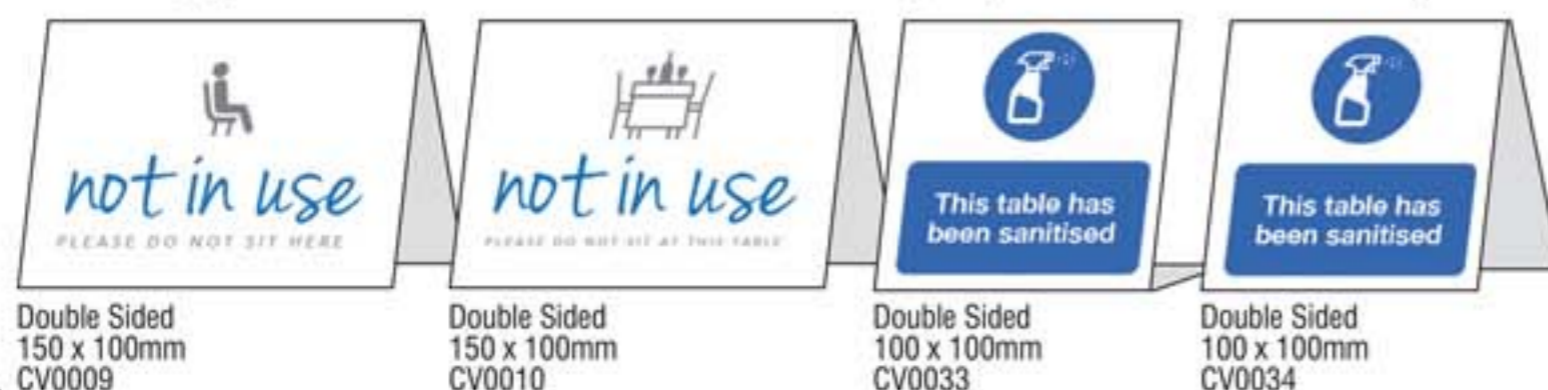

Door Hanger



Ideal for hotels and bed & breakfasts.

Simply place this sign on the door handle to confirm if a room has been cleaned or not.

Double Sided
440 Micron Matt Rigid
80 x 205mm
CV0032

PPE & Hygiene Signs

A range of signage designed to improve safety in schools, shops and workplaces by encouraging good hygiene practices and wearing of PPE where appropriate.



1 8414 H
2 8414 H



1 8413 H
2 8413 H



1 8938 HK
2 8938 HK



Synthetic Paper
420 x 594mm
5 5000



2 1082 U



2 1081 U



2 8419 U



2 8418 U



1 1090 G
2 1090 G

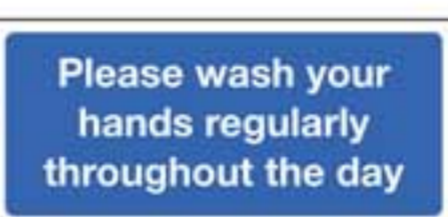

1 8406 H
2 8406 H



1 8476 HK
2 8476 HK



1 8472 HK
2 8472 HK



1 8473 HK
2 8473 HK



1 8585 HK
2 8585 HK



1 1269 HK
2 1269 HK



1 8477 HK
2 8477 HK



1 8479 K
2 8479 K



1 8451 G Fluted Polypropylene
600 x 450mm
5 8451



2 5027 E Self Adhesive Vinyl
150 x 200mm
Pack of 5
5 5027



2 5026 E Self Adhesive Vinyl
150 x 200mm
Pack of 5
5 5026



1 8256 HK
2 8256 HK

Material Codes

1 Rigid Plastic 5 Miscellaneous
2 Self Adhesive Vinyl

Landscape Sizes

E 200 x 150mm G 300 x 100mm K 400 x 300mm
F 200 x 200mm H 300 x 250mm N 400 x 400mm
O 600 x 450mm U 100 x 100mm

Portrait Sizes

H 250 x 300mm
K 300 x 400mm

Stairway, Floor Level & Dwelling ID Signs

To assist the fire and rescue service in identifying each level of a building, storey identification signs indicate the level by "Floor Number" and should be located on every landing of a fire-fighting stairway and every fire-fighting lobby (or open access balcony) into which a fire-fighting lift discharges. Storey ID signs should be supplemented by dwelling indicator signs (positioned directly below the Storey ID sign), which provide information as to the dwellings (flats or maisonettes) located on the storey in question.



 3 2177 L 4 2177 L	 3 2178 L 4 2178 L	 3 2179 L 4 2179 L	 3 2180 L 4 2180 L
 3 2170 L 4 2170 L	 3 2171 L 4 2171 L	 3 2172 L 4 2172 L	 3 2173 L 4 2173 L
 3 2174 L 4 2174 L	 3 2175 L 4 2175 L	 3 2176 L 4 2176 L	 Photoluminescent Rigid Plastic 450 x 150mm 5 2181 Photoluminescent Self Adhesive Vinyl 450 x 150mm 5 2182

Hospitals and Health Services

Some hospitals / health services still display fire exit signs with flames. NHS organisations are now expected to comply with the standard ISO 7010 signage, as found on page 15-17.

 3 2088 GLM 4 2088 GL	 3 2092 GLM 4 2092 GL	 3 2083 GLM 4 2083 GL	 3 2084 GLM 4 2084 GL		
 3 2090 GLM 4 2090 GL	 3 2086 GLM 4 2086 GL	 3 2120 GL	 2 2121 GL 3 2121 GL		
 3 2108 GL	 3 2107 GL	 3 2081 V 4 2081 JV	 3 2082 V 4 2082 JV	 3 2110 F	 3 2109 F

Inclusive Emergency Escape Design

Although not currently ISO 7010 registered this design incorporates both a running man and man using a wheelchair to illustrate an inclusive emergency escape message. Both characters are moving in unison to escape; They display the same urgency and appear to be travelling at the same speed. *Registered designs reproduced under license ©®.

 3 2164 GL 4 2164 GL	 3 2165 GL 4 2165 GL	 3 2162 GL 4 2162 GL	 3 2163 GL 4 2163 GL
--	---	---	---

Emergency Escape for Disabled Persons

This range of signs is specifically designed to assist the safe evacuation of physically disabled people in the event of an emergency. These signs meet the requirements of BS9999:2017 - Code of practice for fire safety in the design, management and use of buildings.

 3 2096 EH	 3 2095 EH 4 2095 E	 3 2091 GL	 3 1227 GL	 3 2098 GL
 3 2096 EH	 3 2146 GL	 3 2089 GL	 3 2087 GL	

Directional Emergency Escape Signs

Emergency escape signs are provided to guide you from wherever you are in a building, via a place of relative safety (the escape route) to the place of ultimate safety (the assembly area). It must not be assumed that everyone will know all safe routes through the building. Emergency escape signs should comply with BS EN ISO 7010:2020 to ensure maximum levels of understanding. The old EC Directive (92/58/EEC) designs should no longer be used due to their low comprehension credentials.



3 2004 **GLM** | Photoluminescent Rigid
4 2004 **GLM** | 900 x 300mm
5 2126



3 2003 **GLM** | Photoluminescent Rigid
4 2003 **GLM** | 900 x 300mm
5 2124



3 2007 **GLM** | Photoluminescent Rigid
4 2007 **GLM** | 900 x 300mm
5 2125



3 2008 **GLM**
4 2008 **GLM**



3 2001 **GL**
4 2001 **GL**



3 2005 **GLM**
4 2005 **GL**



3 2002 **GL**
4 2002 **GL**



3 2006 **GLM**
4 2006 **GL**



3 2012 **GLM**
4 2012 **GLM**



3 2010 **GL**
4 2010 **GL**



3 2014 **GLM**
4 2014 **GL**



3 2016 **GLM**
4 2016 **GLM**



3 2011 **GLM**
4 2011 **GLM**



3 2009 **GL**
4 2009 **GL**



3 2013 **GLM**
4 2013 **GL**



3 2015 **GLM**
4 2015 **GLM**



3 2072 **FU**
4 2072 **FU**



3 2060 **FU**
4 2060 **FU**



3 2043 **FU**
4 2043 **FU**



3 2044 **FU**
4 2044 **U**



3 2034 **CFU**
4 2034 **CU**



3 2037 **CFU**
4 2037 **CU**



3 2038 **CFU**
4 2038 **CFU**



3 2035 **CFU**
4 2035 **C**



3 2039 **CF**
4 2039 **C**



3 2040 **CF**
4 2040 **C**

Regulations state that "text only" signs should not be used on their own. They must be used alongside a running man graphic and, where appropriate, a directional arrow.



3 2041 **F**
4 2041 **F**



3 2122 **F**
4 2122 **F**



3 2042 **F**
4 2042 **F**



3 2057 **JVX**
4 2057 **JVX**



3 2036 **JLVX**
4 2036 **JVX**



3 2056 **JVX**
4 2056 **JVX**



3 2033 **JLVX** | Photoluminescent Rigid Plastic
4 2033 **JVX** | 800 x 400mm
5 2127

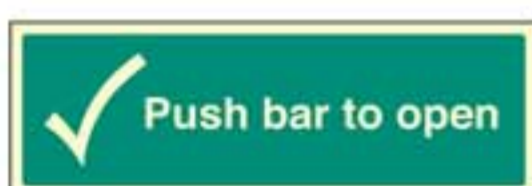

3 2047 **GL**
4 2047 **GL**



3 2049 **GL**
4 2049 **GL**

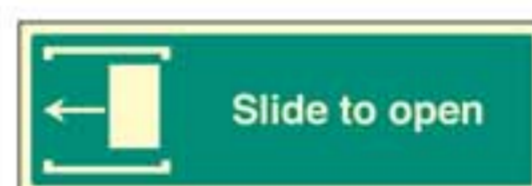

3 2045 **G**
4 2045 **G**

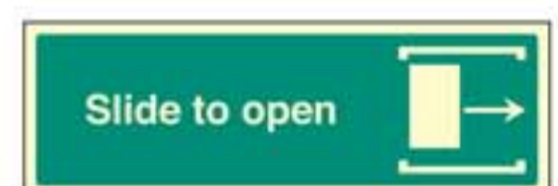

3 2046 **G**
4 2046 **G**



3 2050 **GL**
4 2050 **GL**

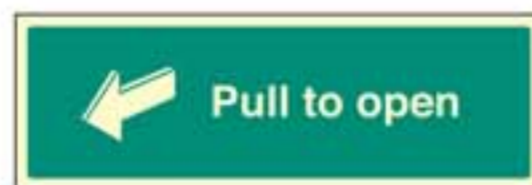

3 2048 **GL**
4 2048 **GL**



3 2051 **GL**
4 2051 **GL**



3 2052 **GL**
4 2052 **GL**



3 2065 **GL**
4 2065 **GL**



3 2061 **GL**
4 2061 **GL**



3 2062 **GL**
4 2062 **GL**



3 2147 **L**



3 2064 **GL**
4 2064 **GL**



Photoluminescent Rigid Plastic 150 x 50mm 5 8661 | Photoluminescent Rigid Plastic 450 x 150mm 5 8662



3 2099 **J** | Place behind a push bar to highlight the bars location.
4 2099 **J**



Intermediate Emergency Escape Markers

In addition to the requirement for installing exit signs at 1.7m - 2.2 metres from the ground, ISO 16069:2017 recommends that additional intermediate markings positioned at a maximum height of 400mm from the floor may also be required. Subject to a full risk assessment, additional escape guidance should be provided through the use of both continuous guidance lines and safety signs to ensure there is an uninterrupted safety sign system to aid safe evacuation from a building.



Class C Photoluminescent Safety Tapes

10 Metre Roll - Self Adhesive Vinyl - Perfect for highlighting door frames and fire fighting equipment



Deluxe Class D Floor Markers

Aluminium back provides extra strength and durability in high traffic areas. Anti-slip surface. Photoluminescent Class D aluminium with adhesive backing.



Class C Floor Markers

Photoluminescent way finding floor markers are an effective method of marking escape routes. These floor markers have an anti-slip surface, strong adhesive backing and come in packs of 20.

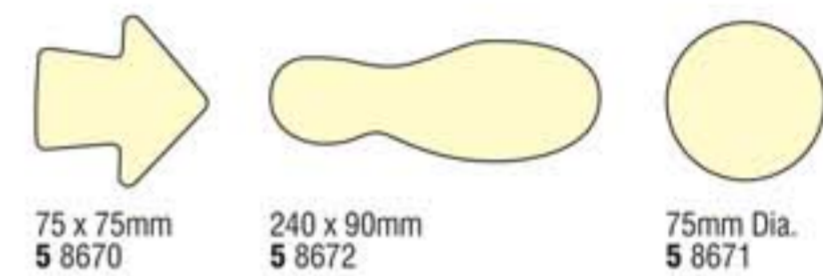

Projecting Signs

Manufactured from photoluminescent rigid plastic these projecting signs are visible from a number of angles. Projecting signs help in the quick identification of fire fighting equipment and suitable fire exit routes. Includes drilling guide for simple installation. Designed to conceal fixings for a neat finish. Face: 150 x 200mm



Door Markers

75 x 300mm - Photoluminescent Rigid Plastic. Install to reinforce the fire escape message. Don't install instead of a fire exit sign above a door.

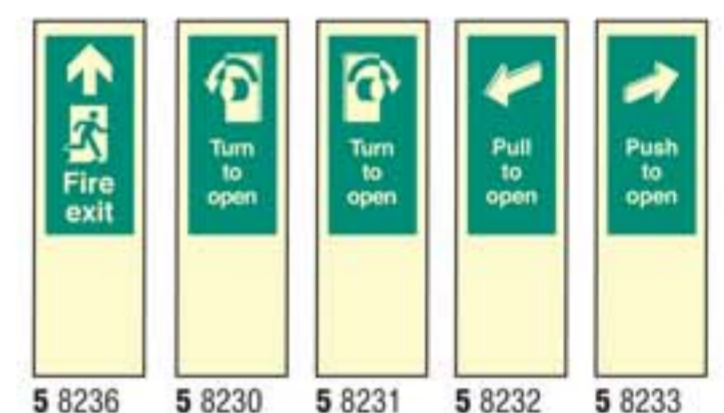

Fire Safety Signs



Fire Extinguisher Location Boards



Extinguisher brackets (*not supplied) should be fixed through the panel and onto the wall. Select the relevant **D** size Extinguisher ID sign (page 6) and apply to top of board in the space provided. Extinguisher ID sign and bracket not included



3mm Photoluminescent Foam PVC
300 x 800mm
5 1029

Fire Extinguisher Information Board

























Display this sign in communal areas. Do not place directly above extinguishers.



3 1226 **L**
4 1226 **L**

Fire Safety Signs

The Regulatory Reform (Fire Safety) Order 2005 places responsibility of fire safety on employers to ensure that a fire risk assessment has been conducted to establish fire risks and that appropriate actions are taken to reduce them. Failure to comply could lead to severe legal penalties. Under the Regulatory Reform (Fire Safety) Order 2005, any non-automatic fire fighting equipment should be positioned and signed in accordance with BS EN ISO 7010:2020 to ensure maximum levels of comprehension. By positioning an appropriate fire equipment sign at a height between 1.7m - 2m from the floor it helps to locate and identify essential fire equipment in the event of it being obscured by furnishings in the room.

 WATER SAFE FOR: Wood, paper and textiles NOT FOR: Flammable liquid fires, Live electrical equipment, Flammable METAL fires 3 1214 S 4 1214 S	 CARBON DIOXIDE SAFE FOR: Flammable liquids, Live electrical equipment NOT FOR: Wood, paper and textiles, Flammable METAL fires 3 1217 S 4 1217 S	 FOAM SPRAY SAFE FOR: Wood, paper and textiles, Flammable liquids NOT FOR: Live electrical equipment, Flammable METAL fires 3 1215 S 4 1215 S	 WET CHEMICAL SAFE FOR: Cooking oils and deep fat fires, Wood, paper and textiles NOT FOR: Flammable liquids, Live electrical equipment, Flammable gases, Flammable METAL fires 3 1231 S 4 1231 S	 WATER SAFE FOR: Wood, paper and textiles NOT FOR: Live electrical equipment, Flammable liquids, Flammable gases, Flammable METAL fires 3 1237 DE 4 1237 DE Photoluminescent Acrylic Stand-off 200 x 150mm 5 1253	 CARBON DIOXIDE SAFE FOR: Flammable liquids NOT FOR: Wood, paper and textiles, Live electrical equipment, Flammable gases, Flammable METAL fires 3 1235 DE 4 1235 DE Photoluminescent Acrylic Stand-off 200 x 150mm 5 1254	 FOAM SPRAY SAFE FOR: Wood, paper and textiles, Flammable liquids NOT FOR: Live electrical equipment, Flammable METAL fires 3 1234 DE 4 1234 DE Photoluminescent Acrylic Stand-off 200 x 150mm 5 1255
 FOAM BRANCH PIPE SAFE FOR: Wood, paper and textiles, Flammable liquids NOT FOR: Live electrical equipment, Flammable METAL fires 3 1219 S 4 1219 S	 MULTI-USE FOAM SAFE FOR: Wood, paper and textiles, Flammable liquids, Cooking oils and deep fat fires NOT FOR: Flammable gases, Flammable METAL fires, Live electrical equipment 3 1249 S 4 1249 S	 ALCOHOL RESISTANT FOAM SAFE FOR: Wood, paper and textiles, Flammable liquids NOT FOR: Live electrical equipment, Flammable METAL fires 3 1244 S 4 1244 S	 ABC POWDER SAFE FOR: Wood, paper and textiles, Flammable liquids, Gaseous fires, Live electrical equipment 3 1233 DE 4 1233 DE Photoluminescent Acrylic Stand-off 200 x 150mm 5 1256	 ABC POWDER SAFE FOR: Wood, paper and textiles, Flammable liquids, Gaseous fires, Live electrical equipment 3 1233 DE 4 1233 DE Photoluminescent Acrylic Stand-off 200 x 150mm 5 1256	 WET CHEMICAL SAFE FOR: Cooking oils and deep fat fires NOT FOR: Flammable liquids, Flammable gases, Live electrical equipment 3 1236 D 4 1236 D	 ALCOHOL RESISTANT FOAM SAFE FOR: Wood, paper and textiles, Flammable liquids NOT FOR: Live electrical equipment, Flammable METAL fires 3 1245 D 4 1245 D
 WATER MIST SAFE FOR: Wood, paper and textiles, Flammable liquids, Gaseous fires, Cooking oils and deep fat fires, Live electrical equipment 3 1257 S 4 1257 S	 L2 POWDER SAFE FOR: Flammable METAL fires (inc. Lithium) NOT FOR: Wood, paper and textiles, Flammable liquids, Flammable gases 3 1242 S 4 1242 S	 P50 FOAM SPRAY SAFE FOR: Wood, paper and textiles, Flammable liquids, Live electrical equipment up to 1kV at a minimum distance of 1m NOT FOR: Flammable METAL fires 3 1119 S 4 1119 S	 FIRE BLANKET USE TO SMOTHER FIRES: Chip pan fires, Deep fat fires, Waste bin fires CLOTHING FIRES: Wrap tightly round someone whose clothes are burning to extinguish flames 3 1218 S 4 1218 S	 L2 POWDER SAFE FOR: Wood, paper and textiles NOT FOR: Live electrical equipment, Flammable liquids, Flammable gases, Flammable METAL fires 3 1246 DE 4 1246 DE	 HYDROSPRAY SAFE FOR: Wood, paper and textiles NOT FOR: Live electrical equipment, Flammable liquids, Flammable gases, Flammable METAL fires 3 1240 DE S 4 1240 DE	 WATER MIST SAFE FOR: Wood, paper and textiles, Flammable liquids, Gaseous fires, Cooking oils and deep fat fires, Live electrical equipment 3 1257 DE 4 1257 DE
 FIRE HOSE REEL SAFE FOR: Wood, paper and textiles NOT FOR: Flammable liquids, Live electrical equipment 3 1221 DE 4 1221 D	 Automatic fire hose reel Instructions for use: 1. Pull hose, 2. Open nozzle, 3. Aim at base of fire NOT FOR: Live electrical equipment 3 1073 E 4 1073 E	 Manual fire hose reel Instructions for use: 1. Open valve fully, 2. Pull hose, 3. Open nozzle, 4. Aim at base of fire NOT FOR: Live electrical equipment 3 1072 E 4 1072 E				

Fire Door Signs

Every fire door should have a "Fire door Keep shut" sign fitted. When doors can be used from both sides a sign is required on both sides. Doors that open on to a fire escape corridor should be locked shut and signed accordingly. The window stickers are all double sided and designed for use on glass doors. They ensure the message is visible from both directions.

 Fire door keep shut 3 1610 B 4 1610 B	 Fire exit keep clear 3 1606 BF 4 1606 BF	 Automatic fire door keep clear 3 1618 B 4 1618 B	 Fire door keep closed 3 1616 B 4 1616 B	 Fire door keep locked shut 3 1621 B 4 1621 B	 This door must be kept closed 3 1608 B 4 1608 B	 Close these doors at night 3 1611 B 4 1611 B	 Fire door keep locked 3 1635 B 4 1635 B	 Fire escape keep clear 3 1605 B 4 1605 B
--	---	---	--	--	--	---	--	---

Photoluminescent Self Adhesive Vinyl Each: 80 x 80mm Sheet of 6
5 9690

Photoluminescent Self Adhesive Vinyl Each: 80 x 80mm Sheet of 6
5 9691

Photoluminescent Self Adhesive Vinyl Each: 80 x 80mm Sheet of 6
5 9693

Photoluminescent Self Adhesive Vinyl Each: 80 x 80mm Sheet of 6
5 9692

Ultra Bright

Exceeds Class C Photoluminescent PSPA rating and is compliant with ISO 16069:2017 (SWGS). The afterglow of Ultra Bright has been tested in accordance with DIN 67510 Pt1 and stays brighter for longer.



Photoluminescent Acrylic Extinguisher ID Signs

For prestige locations why not consider our acrylic stand-off signs to indicate your fire extinguisher ID.

Manufactured from 5mm clear acrylic with a choice of sub-surface print on either a frosted or photoluminescent finish.

See page 93 for more information.

Material Codes

3 Photoluminescent Rigid Plastic
4 Photoluminescent Self Adhesive
5 Miscellaneous

Landscape Sizes

B 80 x 80mm
C 150 x 150mm
D 150 x 100mm
E 200 x 150mm
L 450 x 150mm
U 100 x 100mm
V 300 x 150mm
X 200 x 100mm

Portrait Sizes

E 150 x 200mm
K 300 x 400mm
S 75 x 200mm
X 100 x 200mm

Fire Safety Warnings Signs



3 1213 E
4 1213 E



3 1220 E
4 1220 E



3 1248 EH
4 1248 EH



3 1624 E
4 1624 E

Residential Fire Action Houses of multiple occupancy (HMO) have strict regulations for fire safety and must always have a fire action plan in place.



3 1414 EH Fire Service Dialed Manually
4 1414 EH



3 1418 E Lift in Building
4 1418 E Fire Service Dialed Manually



3 1438 EH Stay Put Policy
4 1438 EH Lift in Building
Fire Service Dialed Manually



2 1416 EH Fire Service Dialed Manually
3 1416 E

Multi-Lingual Fire Action Signs

English, French, German



3 1437 EH Fire Service Dialed Automatically

English, French, German



3 1435 EH Lift in Building
Fire Service Dialed Automatically

English, French, German



3 1436 EH Lift in Building
4 1436 E Fire Service Dialed Manually

English, Polish



3 1440 E Lift in Building
4 1440 E Fire Service Dialed Automatically

EasiFIX Fire Action Kits

These Fire Action EasiFIX Kits provide you with two signs in one. The design enables you to pop out the fire alarm symbol from the main sign then simply slip the main fire action sign around a call point. The "popped out" call point symbol should be placed on the wall above alarm at a height of between 1.7 and 2 metres from the floor.

Manufactured from Photoluminescent Self Adhesive Vinyl Main Sign: 150 x 330mm Pop-out: 100 x 100mm



5 1079 Fire Service Dialed Automatically



5 8220 Fire Service Dialed Automatically



5 8221 Lift in Building
Fire Service Dialed Automatically



5 8223 Fire Service Dialed Manually



5 8224 Fire Service Dialed Manually



5 8225 Lift in Building
Fire Service Dialed Manually



5 8222 Lift in Building
Fire Service Dialed Manually

Fire / Emergency Action Signs



3 1432 **EH** Lift in Building
4 1432 **EH** Fire Service Dialed Manually



3 1426 **EH** Lift in Building
4 1426 **EH** Fire Service Dialed Manually



3 1419 **EH** Lift in Building
4 1419 **EH** Fire Service Dialed Manually



3 1405 **EH** Fire Service Dialed Manually
4 1405 **EH**



3 1420 **EH** Fire Service Dialed Manually
4 1420 **EH**



3 1439 **EH** Fire Service Dialed Manually
4 1439 **EH**



3 1403 **EH** Lift in Building
4 1403 **E** Fire Service Dialed Manually



3 1402 **EH** Lift in Building
4 1402 **E** Fire Service Dialed Manually



3 1401 **EH** Fire Service Dialed Manually
4 1401 **E**



3 1427 **EH** Fire Service Dialed Manually
4 1427 **E**



3 1423 **EH** Fire Service Dialed Manually
4 1423 **EH**



3 1431 **E** Fire Service Dialed Manually



3 1428 **EH** Lift in Building
4 1428 **EH** Fire Service Dialed Automatically



3 1408 **EH** Lift in Building
4 1408 **EH** Fire Service Dialed Automatically



3 1429 **EH** Fire Service Dialed Automatically
4 1429 **EH**



3 1430 **EH**

Custom Signs

Whether it's for a prestigious hotel or an after school club, our custom made signs allow you to get creative and provide a truly unique signage solution. Once you know how you want your sign to look, simply follow the steps below to begin the process of creating a bespoke sign.



1. Choose your Material

When ordering a sign, consideration should be given to the environment it will be located within – is it internal or external? Is it for display in a warehouse or a prestige hotel? Select the required material from the grid below. This grid is not exhaustive so if you can't see the material or size you require please contact us and we will be happy to quote.

Materials	Codes	Details Required for a Custom Sign Quote	Price	Popular Size Choices	
Rigid Plastic	CUST001	<p>Size: Please refer to our "Popular Size" chart or specify your own</p> <p>Orientation: Landscape or Portrait</p> <p>Quantity: Please state your required quantity</p> <p>Content: Please specify or provide artwork</p>	Supplied on Request	80 x 80mm	400 x 200mm
Self Adhesive Vinyl	CUST002			100 x 75mm	400 x 300mm
Photoluminescent Rigid Plastic	CUST003			100 x 100mm	400 x 400mm
Photoluminescent Self Adhesive Vinyl	CUST004			100 x 150mm	450 x 150mm
0.9mm Aluminium	CUST005			150 x 150mm	600 x 200mm
2mm PET (Polyethylene Terephthalate)	CUST006			200 x 75mm	600 x 400mm
Rigid PVC with SAV Backing (Quick Fix)	CUST007			200 x 100mm	600 x 450mm
3mm Foam PVC	CUST008			200 x 150mm	800 x 600mm
5mm Foam PVC	CUST009			200 x 200mm	900 x 600mm
3mm Aluminium Composite	CUST010			210 x 297mm	1050 x 750mm
0.9mm Reflective Aluminium	CUST011			300 x 100mm	1200 x 800mm
PVC Banner with Eyelets	CUST012			300 x 150mm	1200 x 1200mm
4mm Fluted Polypropylene	CUST013			300 x 250mm	2400 x 1200mm

2. Supply Information

In order for our sales team to provide you an accurate quote in addition to material type, please provide the following details: Size, Orientation and Quantity.

3. Provide Artwork

With a team of talented graphic designers and printing experts, we will ensure that each custom sign is set up and manufactured to the highest standards. When ordering your custom sign, simply provide us with the relevant artwork or send us an image, link or sketch your sign idea and we will provide a proof for your review.

1. Sketch & Snap / Scan



Mock up your desired sign, take a picture of it on your phone and send it to us via email. Please don't worry if you're not artistically inclined just remember to include material, colour, text and sizes.

2. Snap & Email



If you've seen a sign you require simply take a photo of it on your phone and send us the picture. We'll then mock up the design based on your instructions and send you a proof to approve, following receipt of your order.

3. Send a Link



Seen a sign you like on a website? Send us the link or a screenshot, along with any additional comments relating to the size, material, or any alterations and we'll provide you with a quote. Please be aware, there may be copyright restrictions.

Image & Logos

Please ensure all images / logos you send are high resolution to achieve a quality print finish. A high resolution file JPEG, PDF, EPS or AI file of your company logo is ideal. **Taking a logo from a home page of a website will not do.** Low-resolution images are the main reason for slow production of custom specials. Have your logo ready prior to order to ensure quick order turnaround.

If you are finding it difficult to find a high-resolution version of your logo you can sometimes find it via [images.google.com](https://www.google.com) simply drag your low-resolution logo file into the search bar and Google will search the internet for images that are similar. If there are any higher resolution logos found on the internet they will load. If all else fails we can reproduce your logo so it prints correctly - additional charges will apply.



0-9

2 Piece Saddle 136
 5S Management 61,72-74
 6S Management 61,72-74
 5 MPH 56,58,67,69,86,90,102-114,120,127,128
 10 MPH 56,58,69,86,90,102-110,114,120,127
 15 MPH 90,103,108,110,114,127
 20 MPH 108,114
 30 MPH 102,108,114

A

A4 Signs 13,15,22-24,28-31,36,41,117
 A5 Signs 12,22,33,35,37
 Abc Powder 6,14,93,94,145
 Abrasive Wheels 36,47
 Abusive Language 84
 Access - Permitted 24,70,89,90,102,104,109,111,115,120,139
 Access - Prohibition 23,35,54-56,67,70,79,89,115,117,120,126-128
 Accident Report Book 43,45
 Acetylene 29
 Acids 27,54,62
 Acrylic Signs 93
 Adapt-A-Sign 88
 Adhesive Fittings 137
 Adr Products 33,99,101
 Aed (Defibrillator) 41,42
 A-Frame Signs 34,52,113
 Alarmed 16,28,80,81,143
 Alcohol 6,22,23,62,84,117,145
 All Drivers Report To 91,104,110,114,126
 All Gender 83,85
 Allergy 32,84
 Ammonia 26
 Anti Climb Paint 28,80,91
 Anti Rotational Clips 136
 Anti-Slip Products 19,35,67,68,140,144
 Antisocial 23,84
 Apologies For Inconvenience 110,114,116,122
 Arc Welding 29,117
 Armband 14,42
 Asbestos 27,54,117,130
 Asphyxiation 26,55
 Assembly Point 20,65,91,104,143
 Assistance 23,86,89
 Authorised Access 35,54,70
 Authorised Person 32,87,97,124
 Automatic Door 33,82

B

Baby Changing 83,89
 Back To Back Clips 136
 Badge Wallet 81,116
 Ball Chain 95
 Banding Straps 136
 Banding Tool 136
 Banksman 24,63,90,115,126
 Banners 15,23,29,36,53,116,117,123,128,129
 Bar Signs 84,85
 Barbed Wire 28,80,91
 Barricade 35,70,75,78,130
 Barrier 35,70,75,78,130
 Barrier Tape 75,130
 Base Plate 113,136
 Bathroom 92
 Battery Acid 27
 Battery Charging 28,48,56,57,66,75,117
 Bend Ahead 108
 Bespoke Signs 148
 Bike Rack 106
 Bin Signs 21,23,25,39,77,83,85,140
 Bins 21,59
 Biohazard 27,54
 Bird Deterrent 23,105
 Blind Spot 102

Book/Doc Holder 14,43,64,133,134
 Boots (Must Be Worn) 36,38,58,67,99,120-128
 Bottles (Recycle) 76
 Boys 83
 Braille 7,9,15,18,22,89
 Break Glass 9,16,143,144
 Broom 72,73
 Bucket 72,73
 Building Waste 77,123
 Bull 79
 Bump Cap 36
 Bungee Ties 122,129,137
 Buried Cables 31,130
 Burns First Aid 42,44
 Busbars 31

C

Cable Ties 126,137
 Call Point 9,11,12,65,94,99,144-147
 Cameras 25,28,102
 Canteen 82,127
 Car Park 11,87,91,103,106,111,114,129
 Cardboard (Recycle) 76,77
 Catering 32,40
 Cattle 79
 Caustic 27,62
 Cctv 28,81,91
 Ceiling Hooks 137
 Chains 17,35,71,95,106,137
 Changing Room 83,86,89
 Check Books 131-135
 Checklists 131-135
 Chemical Store 26,54
 Chemicals 26,47,98
 Children 22,23,44,86,104,108,109,114,117,126,141
 Chlorine 27
 Cigarette Bin 21
 Clamping 80,106
 Clean Up 23,39,40,57,75,98
 Clean/Wash Your Hands 40,44,63,66,83,138-140
 Cleaning In Progress 34,78,84
 Cleaning Station 72,73
 Close Door 8,12,13,77,82,145
 Clp 98,99
 Co2 6,9,14,62,93,94,145
 Compressed Air 26,28,62
 Compressed Gas 26,62,99
 Concealed Entrance 104,115,126
 Cone Barrier 35,130
 Cone Signs 105,111
 Cones 35,111
 Conference Room 82
 Confined Space 26,33,45,55
 Construction 116-130
 Construction Site 29,46,55,91,116,117,123,125,126,129
 Construction Traffic 29,90,91,110,115,117,126,129
 Contractors 81,116
 Corrosive 27,54,62,84,99
 Coshh 26,45,75,98
 Courtesy Sign 110,114,116,122
 Crawling Board 55
 Crushing 28,117
 Custom Signs 3,148
 Customer Parking 87,103
 Cycling 24,102,106,108
 Cylinders 26,39,100,101

D

Daily Inspection Kits 64,132
 Danger Of Death 31,99
 Dangerous Site 55,90,116,127,128
 Dangerous Substance 26,47
 Data Security 52,85
 Data Sheets 54,75

Days Without Accident 43,51,60
 Deep Excavations 29,90,117,119,127,128
 Deep Water 33,55
 Defibrillator 41,42
 Deliveries 103,114
 Deluxe Signs 92-95
 Demolition 29,117,126,128,129
 Design Your Own Signs 3,148
 Designated Area 21,36,37,116,127,129
 Designated Smoking Area 21,127
 Diesel 62,87,101
 Director 103,104
 Disabled (Fire Exit) 18,142
 Disabled (Parking) 69,89,102-104,106,108
 Disabled (Toilet) 83,89,93,94
 Dispensers 38,64,130,134
 Display Screen 52
 Diversion 104,109,111,114,126
 Do Not Climb 25,55,59
 Do Not Close 25
 Do Not Distract 24,102
 Do Not Disturb 54,84,92
 Do Not Enter 35,54,70,75,130
 Do Not Obstruct 8,13,24,39,104
 Do Not Operate 24,25,32,56,97,117
 Do Not Remove 7,24,25,30,123
 Do Not Reverse 24,58,63,90,115,126
 Do Not Sit 23,25,141
 Do Not Stand 23,56,102
 Do Not Step On 23,55
 Do Not Switch On/Off 24,25,56,85,97
 Do Not Touch 23-25,27,56,99
 Do Not Use 7,11,23-25,55,59,78,117,123,140,146
 Do Not Use Lift 11,146
 Do Not Walk 23
 Document Holder 14,45,60,75,98,125,134
 Dogs 23,28,38,39,51,55,79,80,104,116
 Dog (Fouling) 23,39,104
 Door Hanger 84,141
 Door Plates 19,92,144
 Door Screen Sign 78
 Door Sliders 92
 Drain Isolation 57,75
 Drinking Water 43,62,83,89
 Drinks 22,25,84,86
 Drive Slow 39,56,67,69,79,86,104,105,107
 Drones 25,80
 Drugs - Prohibition 22-24,84,102,117
 Dry Riser 9
 Dry Wipe Board 43,53,60
 Drying Room 124,127
 DSEAR 26,47
 Dust 26,54
 Dustpan 72,73

E

Ear Protection 32,37,38,51,54,65,67,72,99
 Easy Wipe Magnetic Strip 60
 Ece 70 Vehicle Plates 100
 Electric Fence 28,80
 Electric Shock 30,31,42,44,45
 Electric Vehicle 39,69,103,105,107,108
 Electrical Cables 31,34,130
 Electrical Warning Labels 30,31,61
 Electrical Warning Signs 7,28,31,39,43
 Electronic Cigarettes 21,22,102
 Electronic Devices 25,80,97
 Elevator Guard 35,78
 Embossed Adr Plates 101
 Emergency Escape 15-20,142-144
 Emergency Lighting 19
 Emergency Spill Kit 57,75,88,98
 Emergency Stop 43
 Emergency Vehicles 13,114,115

Index

Employees Only 23,39
Engraved 92,95
Entrance 22,66,82,89-91,103,104,110,111,114,115,126,129,141
Environmental 72-78
Environmental Hazard 62,77,99
Escape Route 10,13
ESD 31
Evacuation Chair 18,41,143
Exam 86,92
Excavations 29,90,117,119,127,128
Expanding Barrier 70,130
Explosive 26,47,57,99
Explosive Atmosphere 26,47,57,99
Extinguisher 6,7,14,65,94,144,145
Extinguisher Stand 14
Eye Safety/Protection 36,38,41,54,65,67,119,122
Eye Signs 81
Eye Wash 41,42,75

F

Face Shield 36,37
Failed 30,61
Falling (risk of) 29,48,50,55,117
Falling Objects 29,37,117,129
Farm Safety 79,131-135
Fertiliser 79
Fire Action Notice 10-12,18,65,91,94,146,147
Fire Alarm 9,10,65,88-91,99,144,146
Fire Assembly Point 20,65,91,104,143
Fire Blanket 9,94,145
Fire Door 8,12,13,65,88,89,91,94,99,145
Fire Equipment 7,8
Fire Escape (Keep Clear) 13,67,91,145
Fire Exit 12-19,65-67,80,82,189-194,126,142-145
Fire Exit Keep Clear 12,13,16,17,65,66,82,91,143,145
Fire Extinguisher 6,7,14,65,94,144,145
Fire Extinguisher Stand 14
Fire Hose 8,99,144,145
Fire Hydrant 9
Fire Log Book 14,45
Fire Marshal 8,14
Fire Point 8,91,144
Fire Posters 14,46
Fire Safety 6-14
Fire Sprinkler 9
Fire Warden 8,14,88
First Aid 41-45
First Aider 8,41,43,88
Fixings 136,137
Flammable 7,26,54,57,62,99
Flammable Gas 26,57,99
Flammable Liquid 7,26,57,99
Flood 109
Floor (ID) 17,142
Floor Cleaning 34,35
Floor Graphics 15,16,18,22-24,28,35-37,56,66-69,116,117,141
Floor Marking 19,68,144
Floor Safety 66-71
Floor Standing Sign 21-23,34,78,86,97,138
Flu 40,45,138-141
Flush 25,40,83
Fly Tipping 25,77,115
Foam Extinguisher 6,14,93,94,145
Folding ADR Plates 101
Folding Barrier 130
Fold-up Traffic Signs 110,112
Food Allergy 32,84
Food Hygiene 22,23,25,32,40,76,77,84
Footpath 79,112
Footway 109,111,115,126
Footwear 25,36,38,51,65,67,90,99,116,120,126-128
Forklifts - Inspections 49,64,132-135
Forklifts - Mandatory 28,39,56,58,66
Forklifts - Prohibition 24,56,58,67

Forklifts - Warning 28,34,56,58,65-67,69,91
Fragile Roof 29,55,117,123
Frame - Hanging 38,52,82,103,137
Frame - Poster 50,52,53,137
Frame - Traffic 70,106,110,113,136
Free Standing Signs 21-23,34,78,86,97,105,138
French 10,65,146
Fridge 40,85
Fuel 28,43,54,62
Fumes 26

G

Garage Forecourt Signs 57,105
Gas Cylinder 100
Gas Leak 10,147
Gas Shut Off 43,54,100
Gate 22,79,80,82,86,87,115,126
Gate Valve Cover 96
GDPR 45,52,64,85
Gender Equality 83,85
General Waste 59,77
Gents 83,89,92-94
German 10,65,146
GHS 26,47,57,62,98,99
Girls 83
Give Way 67,108,112,114
Glass Highlighting 33
Glass (Recycle) 76
Gloves 36-38,99,122,138
Glow in the Dark Products 6-19,142-147
Glowsticks 14
Goggles 36,38,99,122
Good to Go Safety 131-135
Goods Inward 61,82,103
Grain Silo 79
Grass Cutting 29,109,112,114
Grinding Wheel 24,36,47
Guard Dogs 28,55,80,116
Guards (Machinery) 24,28,31,39,56,117
Guide Dog 23

H

Hand Arm Vibration 32
Hand Protection 36-38,54,99,122,138
Hand Sanitiser 40,140
Handle with Care 25,33,54,61
Handrail 39,86
Hanging Rail 72
Hard Hat 36,72,91,116,120-123,127
Harmful Chemicals 26
Harness 36,37,49,132-135
Hazardous Area 29,34,54,75,78,117
Hazardous Substance Diamond 62,99
Hazardous Substances 98-102
Hazardous Waste 26,54
Hazchem Placards 101
Health Service 18,142
Hearing Loop 89
Hearing Protection 32,37,38,51,54,65,67,72,99
Heat 27,62
Heavy Plant 109,111,115,120,128
Heavy Vehicle 56,102
Hedge Cutting 109,112
Height Restriction 33,106,114
Helmet 36,38,51,65,67,81,90,99,116,120,127,128
High Visibility 36,51,56,65,91,116-130
High Voltage 30-32,54,91,97,130
Highway Maintenance 100
Highly Flammable 26,57,99
Hook (Hanging) 17,42,43,71,72,137
Hook & Loop 137
Horn 39,56,66,67
Hose Reel 8,99,145
Hospital 18,142
Hot Rail 27,83,84

Hot surface 27
Hot water 27,62,83
Hot works 45,54
Hotel 11,84,141
Hydrant 9
Hydrochloric acid 27,62
Hydrogen 62
Hygiene 40,66,83,138-140

I

Ice 33,107
Ice Detector 107
ID Tag 95,123
Impact Protection 33,59
Inclusive Signs 18,83,85,142
Induction 122
Infectious 99,138-141
Information Point 42,43,45,52,57,64,74,125,134
Information Signs 82-95
Inspection Checklists 131-135
Inspection Systems 7,12,30,61,88,131-135
Irritant 27,62,99
Isolate (Electrics) 30-32,97

J

Janitorial 72-78
Jackets 36-38,65,67,91,116

K

Keep Away 31,54,55,116
Keep Clear 7,8,10,12,13,16,18,24,39,43,54-56,65,67,69,82,87,91,94,99,102-104,115,116,129,142-145
Keep Closed 8,12,13,79,80,145
Keep Distance 56,102,138-141
Keep Gate Shut 79,80,82
Keep Left 34,39,86,108,109,111,112,114
Keep Locked 12,13,39,55,91,94,99,145
Keep Off 104
Keep Out 28,55,78,80,87,90,91,94,99,145
Keep Right 34,39,86,108,109,111,112
Keep Shut 12,13,65,89,91,94,99,145
Keep Tidy 21,40,67,74,77
Kerosene 101
Key 16,39,58,143
Key Fob 95
Kitchen 40,85,82,92,139
Kits (Signs) 9,14,69,90,111,121
Knives 40

L

Label holder 60
Labels - Electrical 30,31,99
Labels - Fire 7-9,12,99
Labels - GHS 26,62,99
Labels - Haz Subs 26,27,54,99
Labels - Mandatory 38,99,138,140
Labels - Prohibition 22,24,25,85,99,102
Labels - QC 61
Labels - Shipping 33,61,99
Labels - Warning 26,27,30-32,62,85,99
Ladder 49,55,64,132-135
Ladies 83,89,92-94
Laser 27,99
Lavatory 87
Letters 60,69,107
Life Jacket 37
Lift Correctly 39,48
Lift (Elevator) 10-12,18,24,65,88,91,94,146,147
Lift (Weight) 25,33,61
Limited Height 33,106,114
Limited Quantity 33,99,101
Limited Speed 102
Line Marking 69
Litter 13,39,77
Live wires 23,31,97

Index

S

Safe Working Load 43,59
Safety Data Sheets 54,75
Safety Starts Here 41,67,90,91,115,116,126,129
Sand Bag 110,113
Save Energy 77
Scaffolding 23,25,29,36,46,49,116,117,123,131-135
School 22,86,140
Screws 137
Seatbelt 22,24,87,102
Security 28,52,63,80,81,85,91,106
Security Signs 80-81
Self Standing Signs 21-23,34,78,86,97,105,138
Shadow Board 72,73
Shoplifters 28,81
Shovel 72,73
Shower 41,42,75,83,89
Shred Documents 39,77,85
Shut Off Valve 43,54,100
Sign Clip 113,126,136,137
Sign Fixings 136-137
Sign Frame 38,50,52,53,70,82,103,106,110,113,136,137
Site Entrance 91,110,111,115,129
Site Induction 122
Site Manager 124,127
Site Office 82,91,110,114,124,126,127
Site Safety 109-135
Site Safety Boards 54,90,118-122,127-129,138
Site Safety Rules 122,124
Site Safety Starts Here 41,67,90,91,115,116,126,129
Site Saver Signs 90,126,127
Site Speed Limit 90,110,127
Site Starter Packs 121
Site Traffic 29,91,109-117
Slide to Open 16,143
Slippery Surface 34,35,67,78,84,109
Sloping Floor 35
Slow 39,56,67,69,79,86,100,104-107
Slurry 79
Smoking - Prohibition 21,22,24,40,56,57,65,67,86,94,99,102,115,117
Smoking - Vehicles 22,24,102
Smoking Legislation 22,65
Smoking Shelter 21
Snap Frame 52
Solvents 26
Sorry for Inconvenience 110,114,116
Sound Horn 39,56,66,67
Specials 148
Speed Bump 56,105,108,115,126
Speed Limit 56,58,67,69,86,90,102-110,114,120,127,128
Speed Ramp 56,105,108,115,126
Speed Restriction 102
Spill Kit 57,75,88,98
Spill Station 57,75,98
Spontaneously Combustible 90
Spray Paint 69
Sprinkler 9
Squeegee 72,73
Staff 7,11,83,89,103,147
Staff Only 82,89,92,93,124
Staff Parking 103,104
Staff Room 82
Stairs 11,66,140,141,146
Stand-off Signs 6,93,145
Status Tag 125-131
Stay Put Policy 10,146
Stencils 69,107
Steps 35,42,49,55,64,89,131-135
Stop (Traffic) 28,66,78,86,108,109,114
Stop-Go Sign 109
Stores 23,82,124,127
Strictly No Admittance 23,78
Strong Currents 33

Sudden Drop 29,33,78
Supplementary Plates 109,112,113
Surveillance 63,81,106
Suspended Loads 29,117
Suspended Sign Frame 38,52,82,103,137
Suspicious Items 80
Switch Off / On 24,25,39,56,57,77,85,86,97
SWL 43,59

T

Table Top Signs 9,22,32,84,141
Tactile 7,9,15,18,22,89
Tags - Engraved 95
Tags - Inspection 7,64,123,131-135
Tags - Lockout 25,32,39,56,97
Tags - Prohibition 25,32,56,97,123
Tags - QC 61,74
Tags - Tamper 7,42
Tags - Warning 25,27,32,97,124
Tailgate 28,56,102
Tamper Evident 7,24,25,42,97,131-135
Tamtorque 113,136
Tapes - Anti-slip 68
Tapes - Barrier 75,130
Tapes - Floor marking 65,68
Tapes - Hazard warning 27,130
Tapes - Photoluminescent 19,68,144
Tapes - Reflective 65,100,130
Telephone (Emergency) 9,41
Temporary Road Surface 109,115
Temperature 27,138
Terrorism 80
Test Area 29,117
Tether 37
Thieves 80
Thin Ice 33
Think Safety 51,63
Tidy 21,40,67,74,77
Tipping 25,77,115,117
Toilet 22,25,40,83,87,89,91-93,124,127
Toilet (Female) 83,89,92-94
Toilet (Inspection) 83,88
Toilet (Male) 83,89,92-94
Toilet (Mixed) 83,89,91-93,124
Tools 31,37,72,80,102,124,140
Toxic 26,62,99
Traffic Signs 108-1115
Trailing Cables 34
Tree Cutting 79,109,112
Trespassers 28,79,80,87,124
Trip Hazard 34,35
Trucks 24,28,34,39,56,58,63-69,89,91,107,127,131-135
Turn Left 114
Turn Off 77,83
Turn Right 114
Turn to Open 16,19,143
Tyres 76

U

Unauthorised Entry 54-56,66,90,115,116,120,127,128
Unauthorised Persons 23,24,54,56,67,79,80,90,117,127
Under Age 84
Under the Influence 23,84
Underground Services 31,119,130
Underground Warning Tape 130
Underground Cables 31,130
Uneven Road Surface 29,114,115
Unloading 28,39,117
Unplug 24,85
UV Light 39,54

V

Vacant 92
Valuables 86
Valve Tags 25,95,96
Valves 8,9,25,43,54,95,96,100
Vaping 21,102
Vehicle Inspection 22,24,58,102,131-135
Vehicle Marking 99-102
Vehicle Plate 100,101
Vehicle Warning Triangle 111
Vehicles - Mandatory 9,22,39,56,102,103
Vehicles - Prohibition 21,24,56,102,115,117,126
Vehicles - Security 28,80,81,102
Vehicles - Warning 28,29,56,79,81,87,102,106,114-117,128
Verge Signs 20,21,23,24,104
Vibration 32
Visitor Book 81
Visitors 54,55,81,86,139,140
Visitors (Parking) 87,103-105,127
Visitors (report to) 54,55,86,87,91,104,110,114,115,120,121,124,126,128
Visor 37
Visual Impact Signs 6,93,145
Voltage 30-32,54,91,97,130

W

Walkway 23,28,56,67,110,115
Wall Panels (first aid) 42
Warehouse Labels 60-62
Warehouse Signs 59-65
Warning 26-35
Warning Diamonds 62,99
Wash your Hands 40,44,63,66,83,138,140
Waste 26,27,54,59,62,76,77,123,124
Water - Drinking 25,43,62,83,99
Water - Extinguisher 6,14,93,94,145
Water - ID/markings 43,54,62
Water - Safety 27,29,33,55,77,83
Way Guidance 15-20,142-144
Way In 28,103
Way Out 103,129
WC 83,94
We Apologise For 110,114,116
Weekly Inspection Kits 131-135
Welcome 23,86,104
Welding 29,36,37,56,117
Wellbeing 41,42
Wet Chemical 6,145
Wet Floor 34,35,78,86
Wet Paint 27,34
Wheel Chock 39
Wide Load / Turns 28,100,102
Wildlife 23
Wind 33
Window Signs 7,16,17,39,77,82,123,139
Wireless Devices 25,80
Work in Progress 29,34,56,117,120
Worker ID Tag 123
Works Access 109,115
Works Traffic 90,110,115,126
Workstation 40,52,74
WRAP Recycling 76,77

X Y Z

Zero tolerance 85
Zintec signs 109

Index

S

Safe Working Load 43,59
Safety Data Sheets 54,75
Safety Starts Here 41,67,90,91,115,116,126,129
Sand Bag 110,113
Save Energy 77
Scaffolding 23,25,29,36,46,49,116,117,123,131-135
School 22,86,140
Screws 137
Seatbelt 22,24,87,102
Security 28,52,63,80,81,85,91,106
Security Signs 80-81
Self Standing Signs 21-23,34,78,86,97,105,138
Shadow Board 72,73
Shoplifters 28,81
Shovel 72,73
Shower 41,42,75,83,89
Shred Documents 39,77,85
Shut Off Valve 43,54,100
Sign Clip 113,126,136,137
Sign Fixings 136-137
Sign Frame 38,50,52,53,70,82,103,106,110,113,136,137
Site Entrance 91,110,111,115,129
Site Induction 122
Site Manager 124,127
Site Office 82,91,110,114,124,126,127
Site Safety 109-135
Site Safety Boards 54,90,118-122,127-129,138
Site Safety Rules 122,124
Site Safety Starts Here 41,67,90,91,115,116,126,129
Site Saver Signs 90,126,127
Site Speed Limit 90,110,127
Site Starter Packs 121
Site Traffic 29,91,109-117
Slide to Open 16,143
Slippery Surface 34,35,67,78,84,109
Sloping Floor 35
Slow 39,56,67,69,79,86,100,104-107
Slurry 79
Smoking - Prohibition 21,22,24,40,56,57,65,67,86,94,99,102,115,117
Smoking - Vehicles 22,24,102
Smoking Legislation 22,65
Smoking Shelter 21
Snap Frame 52
Solvents 26
Sorry for Inconvenience 110,114,116
Sound Horn 39,56,66,67
Specials 148
Speed Bump 56,105,108,115,126
Speed Limit 56,58,67,69,86,90,102-110,114,120,127,128
Speed Ramp 56,105,108,115,126
Speed Restriction 102
Spill Kit 57,75,88,98
Spill Station 57,75,98
Spontaneously Combustible 90
Spray Paint 69
Sprinkler 9
Squeegee 72,73
Staff 7,11,83,89,103,147
Staff Only 82,89,92,93,124
Staff Parking 103,104
Staff Room 82
Stairs 11,66,140,141,146
Stand-off Signs 6,93,145
Status Tag 125-131
Stay Put Policy 10,146
Stencils 69,107
Steps 35,42,49,55,64,89,131-135
Stop (Traffic) 28,66,78,86,108,109,114
Stop-Go Sign 109
Stores 23,82,124,127
Strictly No Admittance 23,78
Strong Currents 33

Sudden Drop 29,33,78
Supplementary Plates 109,112,113
Surveillance 63,81,106
Suspended Loads 29,117
Suspended Sign Frame 38,52,82,103,137
Suspicious Items 80
Switch Off / On 24,25,39,56,57,77,85,86,97
SWL 43,59

T

Table Top Signs 9,22,32,84,141
Tactile 7,9,15,18,22,89
Tags - Engraved 95
Tags - Inspection 7,64,123,131-135
Tags - Lockout 25,32,39,56,97
Tags - Prohibition 25,32,56,97,123
Tags - QC 61,74
Tags - Tamper 7,42
Tags - Warning 25,27,32,97,124
Tailgate 28,56,102
Tamper Evident 7,24,25,42,97,131-135
Tamtorque 113,136
Tapes - Anti-slip 68
Tapes - Barrier 75,130
Tapes - Floor marking 65,68
Tapes - Hazard warning 27,130
Tapes - Photoluminescent 19,68,144
Tapes - Reflective 65,100,130
Telephone (Emergency) 9,41
Temporary Road Surface 109,115
Temperature 27,138
Terrorism 80
Test Area 29,117
Tether 37
Thieves 80
Thin Ice 33
Think Safety 51,63
Tidy 21,40,67,74,77
Tipping 25,77,115,117
Toilet 22,25,40,83,87,89,91-93,124,127
Toilet (Female) 83,89,92-94
Toilet (Inspection) 83,88
Toilet (Male) 83,89,92-94
Toilet (Mixed) 83,89,91-93,124
Tools 31,37,72,80,102,124,140
Toxic 26,62,99
Traffic Signs 108-1115
Trailing Cables 34
Tree Cutting 79,109,112
Trespassers 28,79,80,87,124
Trip Hazard 34,35
Trucks 24,28,34,39,56,58,63-69,89,91,107,127,131-135
Turn Left 114
Turn Off 77,83
Turn Right 114
Turn to Open 16,19,143
Tyres 76

U

Unauthorised Entry 54-56,66,90,115,116,120,127,128
Unauthorised Persons 23,24,54,56,67,79,80,90,117,127
Under Age 84
Under the Influence 23,84
Underground Services 31,119,130
Underground Warning Tape 130
Underground Cables 31,130
Uneven Road Surface 29,114,115
Unloading 28,39,117
Unplug 24,85
UV Light 39,54

V

Vacant 92
Valuables 86
Valve Tags 25,95,96
Valves 8,9,25,43,54,95,96,100
Vaping 21,102
Vehicle Inspection 22,24,58,102,131-135
Vehicle Marking 99-102
Vehicle Plate 100,101
Vehicle Warning Triangle 111
Vehicles - Mandatory 9,22,39,56,102,103
Vehicles - Prohibition 21,24,56,102,115,117,126
Vehicles - Security 28,80,81,102
Vehicles - Warning 28,29,56,79,81,87,102,106,114-117,128
Verge Signs 20,21,23,24,104
Vibration 32
Visitor Book 81
Visitors 54,55,81,86,139,140
Visitors (Parking) 87,103-105,127
Visitors (report to) 54,55,86,87,91,104,110,114,115,120,121,124,126,128
Visor 37
Visual Impact Signs 6,93,145
Voltage 30-32,54,91,97,130

W

Walkway 23,28,56,67,110,115
Wall Panels (first aid) 42
Warehouse Labels 60-62
Warehouse Signs 59-65
Warning 26-35
Warning Diamonds 62,99
Wash your Hands 40,44,63,66,83,138,140
Waste 26,27,54,59,62,76,77,123,124
Water - Drinking 25,43,62,83,99
Water - Extinguisher 6,14,93,94,145
Water - ID/markings 43,54,62
Water - Safety 27,29,33,55,77,83
Way Guidance 15-20,142-144
Way In 28,103
Way Out 103,129
WC 83,94
We Apologise For 110,114,116
Weekly Inspection Kits 131-135
Welcome 23,86,104
Welding 29,36,37,56,117
Wellbeing 41,42
Wet Chemical 6,145
Wet Floor 34,35,78,86
Wet Paint 27,34
Wheel Chock 39
Wide Load / Turns 28,100,102
Wildlife 23
Wind 33
Window Signs 7,16,17,39,77,82,123,139
Wireless Devices 25,80
Work in Progress 29,34,56,117,120
Worker ID Tag 123
Works Access 109,115
Works Traffic 90,110,115,126
Workstation 40,52,74
WRAP Recycling 76,77

X Y Z

Zero tolerance 85
Zintec signs 109

Safety Signs Checklist

This checklist can be used to help carry out a safety sign survey of your premises. Although not extensive, it has been designed to help highlight any clear gaps in your current set-up and identify the relevant products to help ensure compliance with British and International Standards. **Upon completion of the checklist, if any of your answers are NO then use the page reference to find the recommended signs to rectify the issue.** You should check the condition of existing signs and replace any that are showing excessive wear and tear, display old symbols or where the graphics are fading as this may make them difficult to read. Look for consistency in terms of graphics / text format to maximise comprehension levels and minimise any risk of uncertainty.

Buckled or Bent Signs



Faded or Sun Damaged Signs



Chipped or Cracked Signs



Incorrect Colours



Old Symbols or Capital Letters



Outside and at Point of Entry into the Building

Page References

Is the assembly point clearly identified?	Y	N	20
If a visitor leaves through a rear fire exit, can he/she find their way to the assembly point?	Y	N	20
Is the designated smoking area clearly defined?	Y	N	21
Are all parking restrictions clearly identified?	Y	N	103 - 107
Are any speed restrictions within the grounds clearly marked?	Y	N	86, 87, 103 - 115
Can the roof be accessed and hold the weight of an average person?	Y	N	29, 55

Entry & Reception

Does the building clearly display at least one updated Health and Safety Law poster?	Y	N	53
Is there a 'No Smoking' sign on display in the building and / or in fleet vehicles?	Y	N	21, 22
Are facilities provided to ensure equality and inclusivity of all staff / visitors?	Y	N	82, 83, 89
As a visitor, is it clear if you need to sign in?	Y	N	81, 86, 114
If there is a CCTV system in use, is there at least one sign stating this?	Y	N	81
Where CCTV is in operation, is it clear who is running the system and how to contact them?	Y	N	81
Does the business have a clear way of informing staff of when a fire drill is due to take place?	Y	N	9

Fire Action, Equipment and Doors

Does every fire alarm call point have a fire action notice above it?	Y	N	10 - 12
Can all fire alarm call points be seen from a distance?	Y	N	9
Can all fire extinguishers, hose reels or fire call points be seen clearly from a distance?	Y	N	6 - 8
Have staff received instructions of what type of fires the fire extinguishers can / not be used on?	Y	N	6 - 7
Are fire doors indicated with a 'Fire door Keep shut' sign?	Y	N	12 - 13
Are all fire doors that open to fresh air clearly marked 'Fire exit Keep clear'?	Y	N	13, 16
Are emergency door push bars or pads clearly signed with the appropriate symbol?	Y	N	16, 143

First Aid

Is the location of the first aid equipment clearly marked?	Y	N	41 - 43
Are first aiders known by all staff members?	Y	N	41
Does your company have an accident report book?	Y	N	43

Toilet / Washroom Signs

Are the hot water taps, which could reach a harmful temperature, clearly signed?	Y	N	27
Do 'wash hands' signs currently appear in all washrooms?	Y	N	40, 138 - 141
Are policies on energy saving and recycling clearly indicated?	Y	N	76, 77
Are no smoking signs displayed in toilets / washrooms?	Y	N	22
Can visitors easily locate the toilets / washrooms? Is everyone catered for?	Y	N	83, 92 - 94

Access / Restriction around the Building

Are customers, visitors or new starters aware of areas they are restricted from entering?	Y	N	23
Are all height hazards clearly marked? (e.g. low ceilings, overhangs or areas with low clearance)	Y	N	29, 33
Are unexpected trip hazards or changes in flooring levels marked?	Y	N	35
Do all visible hazards have the correct sign next to them?	Y	N	26 - 35

Factories and Warehouses

Are there any requirements to wear specific PPE? Is this highlighted at all points of entry?	Y	N	36 - 38
Is all dangerous working equipment clearly marked with measures to be aware of?	Y	N	28, 32, 39, 56
Are all staff / visitors aware that forklifts operate in the area?	Y	N	28, 56, 58
Are signs in place to warn of potential reversing vehicles?	Y	N	24, 28, 56
Are there appropriate signs next to any 'Hot Works'?	Y	N	54
If any part of the building contains Asbestos, is it properly marked and managed?	Y	N	27, 54
Do all of the triangular warning signs display either 'Danger', 'Warning' or 'Caution'?	Y	N	26 - 35
Are routine equipment inspections carried out in compliance with PUWER?	Y	N	131 - 135

Fire Escape Signage

Do all Exit and Fire Exit signs show an ISO 7010 compliant running man?	Y	N	15 - 19, 142 - 144
With the exception of an office with one door out, can fire exit signs be seen from every area?	Y	N	15, 17, 19
Is there a fire exit sign pointing right or left above any door?	Y	N	15 - 19, 142 - 144
Would fire exit signs be visible in smoky / dark conditions for sufficient time to exit the building?	Y	N	15 - 19, 142 - 144

Notes / Comments

everybody matters

OnSite Support
Stephenson Way
Three Bridges, Crawley
West Sussex RH10 1TN

01293 744 444
hello@onsite-support.co.uk

